

Classificação Cooperativa de Patentes (CPC) - Introdução

Módulo Avançado - Complementar I

Pesquisadores da DIESP / DIRPA / INPI

Rio de Janeiro, 27 de julho de 2018.

ATENÇÃO:

Este material complementa conhecimentos apresentados anteriormente nos módulos do Nível Básico e no tutorial sobre a Classificação Internacional de Patentes.

Caso ainda não os tenha lido, por favor acesse-os [aqui](#) antes de prosseguir.

Este guia foi elaborado para ser utilizado como apresentação em pdf, devido aos links que facilitam o acesso direto a vários portais.

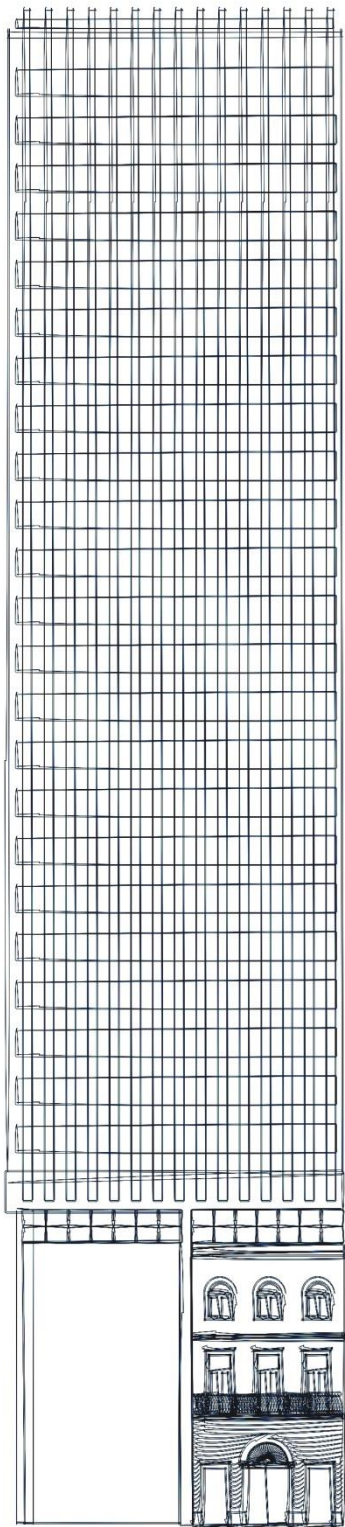

Sumário

Introdução e cobertura da CPC

Estrutura da CPC

A CPC no Espacenet

**Exemplos de utilização do portal do
esquema de classificação da CPC**

Considerações finais

Introdução e cobertura da CPC

Introdução

- As buscas exemplificadas nos módulos do Nível Básico utilizam a Classificação Internacional de Patentes (IPC) como filtro para localizar patentes na área tecnológica de interesse.
- Entretanto, esta não é a única classificação que pode ser usada nas bases apresentadas: uma outra opção na base Espacenet é a CPC (Cooperative Patent Classification, em inglês, ou Classificação Cooperativa de Patentes).

A Classificação Cooperativa de Patentes - Cooperative Patent Classification (CPC)

- Lançada em janeiro de 2013 , a CPC é fruto de cooperação entre os escritórios Europeu de Patentes (EPO) e Norte-Americano de Patentes e Marcas (USPTO).
- É uma classificação mais detalhada, permitindo maior precisão na busca e recuperação de documentos de patente:
 - aproximadamente
 - 250.000 itens de classificação (CPC) X 70.000 itens (IPC).

A Classificação Cooperativa de Patentes

- Cooperative Patent Classification (CPC)

Devido ao nível de detalhamento, o uso da CPC em buscas de patentes leva a resultados mais precisos e reduz o número de palavras chave necessárias. Isto ocorre para as patentes já classificadas pela CPC, conjunto que representa uma parte de todas as patentes no mundo.

- Por exemplo, a CPC está presente nas coleções completas dos documentos de patente EP e US, depositados nos escritórios Europeu e dos Estados Unidos e que podem ser acessados no [Espacenet](#) e no [USPTO](#).
- Cerca de 40 milhões de documentos de patente no mundo já possuem classificação CPC*.

• [*Guide to the CPC](#) - pg.19

Cobertura da CPC

Quatro grandes organizações têm documentos de patente classificados pela CPC**:

- EPO – Escritório Europeu de Patentes



- OMPI – Organização Mundial de Propriedade Intelectual



- ARIPO - Organização Regional Africana da Propriedade Intelectual



- OAPI - Organização Africana da Propriedade Intelectual



**[Guide to the CPC](#) - pg.19

Cobertura da CPC

- Patentes dos EUA, Alemanha, Bélgica e França, a partir dos anos 1800, já estão classificadas pela CPC. Da Grã-Bretanha, Holanda, Luxemburgo e Suíça, a partir do início do século XX. Da Áustria, Austrália e Canadá, a partir dos anos 1970***.
- Portanto, a busca de patentes usando a CPC para documentos destes países traz resultados consistentes.

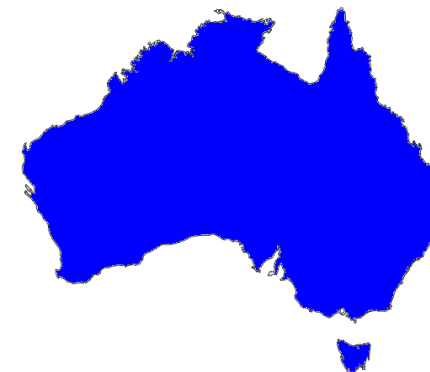
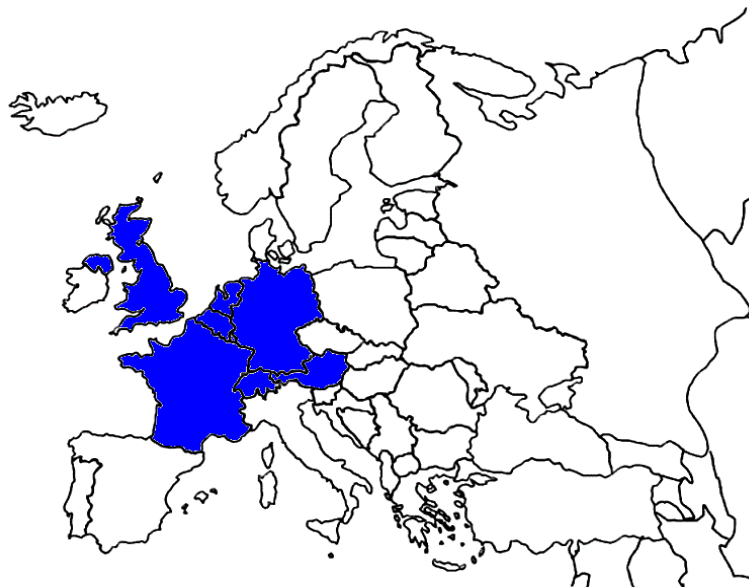

■ documentação completa ou quase completa classificada pela CPC

***[Guide to the CPC](#) - pg.19

Mapas: CEDIN, julho de 2015

Cobertura da CPC

- Gradualmente, cresce o número de países utilizando a CPC para a classificação de seus documentos de patente.
- Anualmente, 2 milhões de novos documentos são classificados pela CPC****.
- O INPI (Brasil) também está classificando documentos recentes pela CPC, desde dezembro de 2014.

****[CPC at national offices](#) - pg.5

Exemplo de folha de rosto de documento nacional classificado pela CPC



República Federativa do Brasil
Ministério do Desenvolvimento, Indústria
e Comércio Exterior
Instituto Nacional da Propriedade Industrial

(21) BR 20 2013 011885-6 U2



(22) Data de Depósito: 06/05/2013

(43) Data da Publicação: 02/06/2015
(RPI 2317)

(54) Título: SUPORTE EM CONE PARA ALIMENTOS

(51) Int.Cl.: B65D75/58; B65D3/26; A47G21/00;
B65D3/06; B65D85/78

(52) CPC: B65D75/5844; B65D3/262; A47G21/001;
B65D3/06; B65D85/78

(73) Titular(es): FUNDAÇÃO UNIVERSIDADE FEDERAL
DE SÃO CARLOS

(72) Inventor(es): BRUNO MAEKAWA NODOMI,
MATHEUS BARROS MACÊDO, NILTON LUIZ
MENEGON, RAUL ATIQUÉ RODRIGUES SILVA

(57) Resumo: SUPORTE EM CONE PARA ALIMENTOS

A presente patente de Modelo de Utilidade descreve um suporte (1) em cone para alimentos (2) dito suporte compreendendo uma peça única em quatro partes, a saber, três tiras (8) paralelas dotadas de recortes (3) e abas (6) que auxiliam no destaque das tiras (8) à medida que o alimento é consumido, e o fundo ou parte inferior (5). As extremidades do suporte (1) são fixadas uma à outra por bordas (4). A geometria do suporte (1) é tal que a parte inferior (5) apresenta maior durabilidade e resistência comparada às outras faces do suporte (1), tal efeito sendo resultante da união das dobras do papel. O suporte (1) apresenta ainda um espaço (7) destinado a anúncios publicitários

Tanto a CPC como a IPC constam na folha de rosto do pedido de patente.

A IPC ainda é a classificação comum a mais de 90 países.

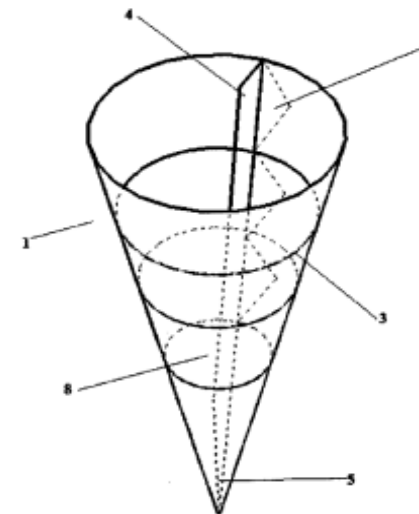

Estrutura da CPC

Estrutura da Classificação Cooperativa de Patentes (CPC)

Divide o conhecimento tecnológico em nove grandes áreas (Seções):

- **Seção A** - Necessidades Humanas
- **Seção B** - Operações de Processamento; Transporte
- **Seção C** - Química e Metalurgia
- **Seção D** - Têxteis e Papel
- **Seção E** - Construções Fixas
- **Seção F** - Eng. Mecânica; Iluminação; Aquecimento; Armas; Explosão
- **Seção G** - Física
- **Seção H** - Eletricidade
- **Seção Y** - Novos Desenvolvimentos Tecnológicos

Esta estrutura é análoga à estrutura da Classificação Internacional de Patentes. Porém, além de apresentar uma nova Seção (Y) e maior quantidade de subclassificações, ela não é simplesmente um detalhamento da IPC.

Seção Y: novos desenvolvimentos tecnológicos

A CPC possui a seção **Y**, destinada à classificação de novos desenvolvimentos tecnológicos, ou “tecnologias emergentes”, ou ainda tecnologias que abrangem de forma inter-relacionada diversos setores da CPC.

A seção **Y** está dividida em três Classes:

- Y02** - abrange tecnologias visando mitigação de, ou adaptação às, mudanças climáticas;
- Y04** - tecnologias de telecomunicações ou de sistemas de informação com impacto / influência em outras áreas tecnológicas;
- Y10** - assuntos técnicos cobertos pela classificação anterior de patentes norte-americana.

Seção Y: novos desenvolvimentos tecnológicos

A classe **Y02** inclui tecnologias voltadas aos efeitos de mudanças climáticas, como por exemplo:

- tecnologias para mitigação das mudanças climáticas relacionadas com edificações, por exemplo, captura, armazenagem e eliminação de gases causadores do efeito-estufa;
- tecnologias para a redução da emissão de gases do efeito estufa relacionados à geração, transmissão ou distribuição de energia;
- tecnologias para mitigação das mudanças climáticas relacionadas ao tratamento ou gestão de resíduos.

Seção Y: novos desenvolvimentos tecnológicos

A classe **Y04** inclui tecnologias de informação e comunicação voltadas à área de energia elétrica, como:

- sistemas integrando tecnologias relacionados à operação de redes de alta potência;
- tecnologias de comunicação ou informação para melhorias da geração de energia elétrica;
- geração, transmissão, distribuição, gerenciamento ou uso da energia elétrica (redes inteligentes).

As classes **Y02** e **Y04** foram criadas para monitorar novos desenvolvimentos tecnológicos e são sempre usadas em conjunto com as classificações específicas das outras seções.

A CPC no Espacenet

Para acessar a CPC, selecione “Classification search”, indicada abaixo.

Europäisches Patentamt
European Patent Office
Office européen des brevets

Espacenet
Patent search

worldwide.espacenet.com

Deutsch English Français
Contact
Change country ▼

◀ About Espacenet Other EPO online services ▼

Search Result list My patents list (0) Query history Settings Help

Smart search
Advanced search
Classification search

Espacenet: free access to the database of over 90 million patents

Smart search:

Maintenance news -

Espacenet outages
Time zone: CET
Mon-Sun 05:00-ca.05:30

→ [read more...](#)

News flashes +

Latest updates +

Related links +

New in Espacenet.
[Global dossier with data from Japan and Korea.](#)

Job vacancies
The EPO will be recruiting engineers and scientists as patent examiners in 2015. [Apply now for our Spring selection events.](#)

Espacenet: [Intro](#)

Classificação Cooperativa de Patentes (CPC) no Espacenet



Europäisches Patentamt
European Patent Office
Office européen des brevets

Espacenet
Patent search

Deutsch English Français
Contact
Change country ▾

◀ About Espacenet Other EPO online services ▾

Search Result list My patents list (0) Query history Settings Help

Smart search
Advanced search
Classification search

Quick help —

- [What is the Cooperative Patent Classification system?](#)
- [How do I enter classification symbols?](#)
- [What do the different buttons mean?](#)
- [Can I retrieve a classification using keywords?](#)
- [Can I start a new search using the classifications listed?](#)
- [Where can I view the description of a particular CPC class?](#)
- [What is the meaning of the stars in front of the classifications found?](#)
- [What does the text in brackets mean?](#)

Selected classifications
nothing selected

Find patents
Copy to search form

Cooperative Patent Classification

Search for Search View section **Index** A | B | C | D | E | F | G | H | Y

A »

Symbol	Classification and description		
<input type="checkbox"/> A	HUMAN NECESSITIES		
<input type="checkbox"/> B	PERFORMING OPERATIONS; TRANSPORTING		
<input type="checkbox"/> C	CHEMISTRY; METALLURGY		
<input type="checkbox"/> D	TEXTILES; PAPER		
<input type="checkbox"/> E	FIXED CONSTRUCTIONS		
<input type="checkbox"/> F	MECHANICAL ENGINEERING; LIGHTING; HEATING; WEAPONS; BLASTING ENGINES OR PUMPS		
<input type="checkbox"/> G	PHYSICS		
<input type="checkbox"/> H	ELECTRICITY		
<input type="checkbox"/> Y	GENERAL TAGGING OF NEW TECHNOLOGICAL DEVELOPMENTS; GENERAL TAGGING OF CROSS-SECTIONAL TECHNOLOGIES SPANNING OVER SEVERAL SECTIONS OF THE IPC; TECHNICAL SUBJECTS COVERED BY FORMER USPC CROSS-REFERENCE ART COLLECTIONS [XRACs] AND DIGESTS		

Atenção:
Esta classificação está disponível somente no idioma inglês.

Para detalhes de uma classificação, clicar na classificação desejada (escolher uma, de A a H, ou Y).

Cooperative Patent Classification

Search for

View section **Index** | A | B | C | D | E | F | G | H | Y



A »

Symbol	Classification and description		
<input type="checkbox"/> A	HUMAN NECESSITIES	<input type="checkbox"/> S	
<input type="checkbox"/> B	PERFORMING OPERATIONS; TRANSPORTING	<input type="checkbox"/> S	<input type="checkbox"/> I
<input type="checkbox"/> C	CHEMISTRY; METALLURGY	<input type="checkbox"/> S	<input type="checkbox"/> I
<input type="checkbox"/> D	TEXTILES; PAPER	<input type="checkbox"/> S	
<input type="checkbox"/> E	FIXED CONSTRUCTIONS	<input type="checkbox"/> S	
<input type="checkbox"/> F	MECHANICAL ENGINEERING; LIGHTING; HEATING; WEAPONS; BLASTING ENGINES OR PUMPS	<input type="checkbox"/> S	<input type="checkbox"/> I
<input type="checkbox"/> G	PHYSICS	<input type="checkbox"/> S	<input type="checkbox"/> I
<input type="checkbox"/> H	ELECTRICITY	<input type="checkbox"/> S	<input type="checkbox"/> I
<input type="checkbox"/> Y	GENERAL TAGGING OF NEW TECHNOLOGICAL DEVELOPMENTS; GENERAL TAGGING OF CROSS-SECTIONAL TECHNOLOGIES SPANNING OVER SEVERAL SECTIONS OF THE IPC; TECHNICAL SUBJECTS COVERED BY FORMER USPC CROSS-REFERENCE ART COLLECTIONS [XRACs] AND DIGESTS	<input type="checkbox"/> S	<input type="checkbox"/> I

Por exemplo, pode-se selecionar **A**, de Necessidades Humanas (“Human Necessities”), e em seguida **A43**, referente a Calçados (“Footwear”):

Symbol	Classification and description
<input type="checkbox"/> A	HUMAN NECESSITIES
<input type="checkbox"/> B	PERFORMING OPERATIONS; TRANSPORTING

Symbol	Classification and description
<input type="checkbox"/> A	HUMAN NECESSITIES
AGRICULTURE	
<input type="checkbox"/> A01	AGRICULTURE; FORESTRY; ANIMAL HUSBANDRY; HUNTING; TRAPPING; FISHING
FOODSTUFFS; TOBACCO	
<input type="checkbox"/> A21	BAKING; EDIBLE DOUGHS
<input type="checkbox"/> A22	BUTCHERING; MEAT TREATMENT; PROCESSING POULTRY OR FISH
<input type="checkbox"/> A23	FOODS OR FOODSTUFFS; THEIR TREATMENT, NOT COVERED BY OTHER CLASSES
<input type="checkbox"/> A24	TOBACCO; CIGARS; CIGARETTES; SMOKERS' REQUISITES
PERSONAL OR DOMESTIC ARTICLES	
<input type="checkbox"/> A41	WEARING APPAREL
<input type="checkbox"/> A42	HEADWEAR
<input type="checkbox"/> A43	FOOTWEAR
<input type="checkbox"/> A44	HABERDASHERY; JEWELLERY
<input type="checkbox"/> A45	HAND OR TRAVELLING ARTICLES
<input type="checkbox"/> A46	BRUSHWARE
<input type="checkbox"/> A47	FURNITURE (arrangements of seats for, or adaptations of seats to, vehicles B60N); DOMESTIC ARTICLES OR APPLIANCES; COFFEE MILLS; SPICE MILLS; SUCTION CLEANERS IN GENERAL (ladders E06C)
HEALTH; AMUSEMENT	
<input type="checkbox"/> A61	MEDICAL OR VETERINARY SCIENCE
<input type="checkbox"/> A62	LIFE-SAVING; FIRE-FIGHTING (ladders E06C)
<input type="checkbox"/> A63	SPORTS; GAMES; AMUSEMENTS
PERSONAL OR DOMESTIC ARTICLES	
<input type="checkbox"/> A43	FOOTWEAR
<input type="checkbox"/> A43B	CHARACTERISTIC FEATURES OF FOOTWEAR; PARTS OF FOOTWEAR
<input type="checkbox"/> A43C	FASTENINGS OR ATTACHMENTS OF FOOTWEAR; LACES IN GENERAL
<input type="checkbox"/> A43D	MACHINES, TOOLS, EQUIPMENT OR METHODS FOR MANUFACTURING OR REPAIRING FOOTWEAR

Localizando uma classificação na CPC

O campo abaixo pode ser utilizado tanto para acessar uma determinada classificação da CPC, como para buscar classificações possíveis, usando uma determinada palavra-chave.

Cooperative Patent Classification

Search for View section **Index** | A | B | C | D | E | F | G | H | Y |

← → ☰ ☱ ⓘ CPC ☲ ☳ ☴ ☵ ☶ ☷ 2000 A »

Symbol	Classification and description	S	I
<input type="checkbox"/> A	HUMAN NECESSITIES	<input type="checkbox"/>	<input type="checkbox"/>
<input type="checkbox"/> B	PERFORMING OPERATIONS; TRANSPORTING	<input type="checkbox"/>	<input type="checkbox"/>
<input type="checkbox"/> C	CHEMISTRY; METALLURGY	<input type="checkbox"/>	<input type="checkbox"/>
<input type="checkbox"/> D	TEXTILES; PAPER	<input type="checkbox"/>	<input type="checkbox"/>
<input type="checkbox"/> E	FIXED CONSTRUCTIONS	<input type="checkbox"/>	<input type="checkbox"/>
<input type="checkbox"/> F	MECHANICAL ENGINEERING; LIGHTING; HEATING; WEAPONS; BLASTING ENGINES OR PUMPS	<input type="checkbox"/>	<input type="checkbox"/>
<input type="checkbox"/> G	PHYSICS	<input type="checkbox"/>	<input type="checkbox"/>
<input type="checkbox"/> H	ELECTRICITY	<input type="checkbox"/>	<input type="checkbox"/>
<input type="checkbox"/> Y	GENERAL TAGGING OF NEW TECHNOLOGICAL DEVELOPMENTS; GENERAL TAGGING OF CROSS-SECTIONAL TECHNOLOGIES SPANNING OVER SEVERAL SECTIONS OF THE IPC; TECHNICAL SUBJECTS COVERED BY FORMER USPC CROSS-REFERENCE ART COLLECTIONS [XRACs] AND DIGESTS	<input type="checkbox"/>	<input type="checkbox"/>

Cooperative Patent Classification

Search for

Seguem exemplos, para demonstrar alguns recursos do esquema da CPC.

Exemplos de utilização do portal do esquema de classificação da CPC

Classificação de um objeto de busca na CPC, usando uma palavra- chave

Exemplo 1- chuveiro

Usando o termo “shower” (chuveiro) e selecionando “Search”, são sugeridas classificações para o assunto. Um maior detalhamento surge ao clicar sobre a classificação escolhida, como por exemplo **A47K 3/00**.

Cooperative Patent Classification

Search for **shower** View section | [Index](#) | [A](#) | [B](#) | [C](#) | [D](#) | [E](#) | [F](#) | [G](#) | [H](#) | [Y](#)

« H05K999/00 Y02 »

Symbol	Classification and description
▼ ★★★★★ <input type="checkbox"/> A47K 3/00	Baths; Douches; Appurtenances therefor (for curative purposes A61H , A61M , e.g. bathing devices for special therapeutic or hygienic purposes A61H 33/00 ; {spray heads B05B ; devices for suspending or supporting the supply pipe or supply hose of a shower bath E03C 1/06 ; heated bath tubs F24H 1/0072 })
▼ ★★★★★★ <input type="checkbox"/> B05B 1/00	Nozzles, spray heads or other outlets, with or without auxiliary devices such as valves, heating means (B05B 3/00 , B05B 5/00 , B05B 7/00 take precedence; { nozzles for baths with water or gas jets A61H 33/00 , e.g. A61H 33/6063 , A61H 33/6021 , A61H 33/026 or A61H 33/027 ; Nozzles specially adapted for fire-extinguishing A62C 31/02 ; Nozzles for generating high velocity abrasive fluid jets B24C 5/04 } ; nozzles for jet-ink printing mechanisms B41J 2/135 ; { Nozzles for filling containers B65B 39/00 ; } nozzles for liquid-dispensing, e.g. in vehicle service stations B67D 7/42)
▼ ★★★★★★ <input type="checkbox"/> E03C 1/00	Domestic plumbing installations for fresh water or waste water; Sinks { (work tops A47B 77/022)}
▼ ★★★★★★ <input type="checkbox"/> H01L 21/00	Processes or apparatus adapted for the manufacture or treatment of semiconductor or solid state devices or of parts thereof ({testing or measuring during manufacture or treatment, or reliability measurements H01L 22/00 ; multistep manufacturing processes for passive two-terminal components without a potential-jump or surface barrier for integrated circuits H01L 28/00 ; }processes or apparatus peculiar to the manufacture or treatment of devices provided for in groups H01L 31/00 to H01L 51/00 or of parts thereof, see these groups; single-step processes covered by other subclasses, see the relevant subclasses, e.g. C23C , C30B ; photomechanical production of textured or patterned surfaces, materials or originals therefor, apparatus specially adapted therefor, in general G03F)

Observa-se o grande número de subdivisões da classificação na CPC:







- ★★ **A47K 3/00** Baths; Douches; Appurtenances therefor (for curative purposes [A61H](#), [A61M](#), e.g. bathing devices for special therapeutic or hygienic purposes [A61H 33/00](#); {spray heads [B05B](#); devices for suspending or supporting the supply pipe or supply hose of a shower bath [E03C 1/06](#); heated bath tubs [F24H 1/0072](#)})
- A47K 3/001** • {Accessories for baths, not provided for in other subgroups of group [A47K 3/00](#) (bath lifting devices for sick persons and invalids [A61G 7/10](#)); Insertions, e.g. for babies; Tubs suspended or inserted in baths; Security or alarm devices; Protecting linings or coverings; Devices for cleaning or disinfecting baths; Bath insulation}
- A47K 3/002** •• {Non-slip mats for baths}
- A47K 3/003** •• {Grips for baths}
- A47K 3/004** •• {Trays}
- A47K 3/005** •• {Tap covers for protection against injury}
- A47K 3/006** • {Doors to get in and out of baths more easily}
- A47K 3/007** • {Tipping-devices for baths}
- A47K 3/008** • {Sealing between wall and bathtub or shower tray}
- A47K 3/02** • Baths (heatable [F24H](#))
- A47K 3/022** •• specially adapted for particular use, e.g. for washing the feet, for bathing in sitting position ({doors to get in and out of baths more easily [A47K 3/006](#)}; collapsible baths [A47K 3/062](#))
- A47K 3/024** ••• specially adapted for use for children or babies
- A47K 3/03** •• attachable to other baths, sinks, wash-basins, or the like {mounting frames for therefor} (collapsible baths [A47K 3/07](#))
- A47K 3/034** ••• specially adapted for use for children or babies
- A47K 3/04** •• Built-in baths ({[A47K 3/16](#) takes precedence)}

Comparativamente, segue abaixo representação da mesma classificação **A47K 3/00** na Classificação Internacional de Patentes (IPC).

Classificação Internacional de Patentes (IPC):

IP SERVICES International Patent Classification (IPC) Official Publication

PROPERTY ORGANIZATION

Scheme	RCL	Compilation	Catchwords	Guide to the IPC
 A47K 3/00		Baths; Showers; Appurtenances therefor (for curative purposes A61H , A61M , e.g. bathing device)		
 A47K 3/02		· Baths (combined with showers A47K 3/20 ; heatable F24H) [2006.01]		
 A47K 3/022		· · specially adapted for particular use , e.g. for washing the feet, for bathing in sitting position (collap		
 A47K 3/024		· · · specially adapted for use for children or babies [2006.01]		
 A47K 3/03		· · attachable to other baths, sinks, wash-basins, or the like (collapsible baths A47K 3/07) [2006.01]		
 A47K 3/034		· · · specially adapted for use for children or babies [2006.01]		
 A47K 3/04		· · Built-in baths [2006.01]		

Comparação entre a CPC e a IPC

Cooperative Patent Classification

Search for Search View section | Index | A | B | C | D | E | F | G | H | Y

« A47K1/00 A47K4/00 »

Symbol	Classification and description
★★★★ <input type="checkbox"/> A47K 3/00	Baths; Douches; Appurtenances therefor (for curative purposes A61H , A61M , e.g. bathing devices for special therapeutic or hygienic purposes A61H 33/00 ; {spray heads B05B ; devices for suspending or supporting the supply pipe or supply hose of a shower bath E03C 1/06 ; heated bath tubs F24H 1/0072 })
<input type="checkbox"/> A47K 3/001	•{Accessories for baths, not provided for in other subgroups of group A47K 3/00 (bath lifting devices for sick persons and invalids A61G 7/10); Insertions, e.g. for babies; Tubs suspended in baths; Security or alarm devices; Protecting linings or coverings; Devices for cleaning or disinfecting baths; Bath insulation}
<input type="checkbox"/> A47K 3/002	••{Non-slip mats for baths}
<input type="checkbox"/> A47K 3/003	••{Grips for baths}
<input type="checkbox"/> A47K 3/004	••{Trays}
<input type="checkbox"/> A47K 3/005	••{Tap covers for protection against injury}
<input type="checkbox"/> A47K 3/006	•{Doors to get in and out of baths more easily}
<input type="checkbox"/> A47K 3/007	•{Tipping-devices for baths}
<input type="checkbox"/> A47K 3/008	•{Sealing between wall and bathtub or shower tray}
<input type="checkbox"/> A47K 3/02	• Baths (heatable F24H)
<input type="checkbox"/> A47K 3/022	•• specially adapted for particular use, e.g. for washing the feet, for bathing in sitting position ({doors to get in and out of baths more easily A47K 3/006 }; collapsible baths A47K 3/062)
<input type="checkbox"/> A47K 3/024	••• specially adapted for use for children or babies
<input type="checkbox"/> A47K 3/03	•• attachable to other baths, sinks, wash-basins, or the like {mounting frames for therefor} (collapsible baths A47K 3/07)
<input type="checkbox"/> A47K 3/034	••• specially adapted for use for children or babies
<input type="checkbox"/> A47K 3/04	•• Built-in baths ({ A47K 3/16 takes precedence})

CPC

Pode-se observar que a CPC permite classificar o objeto de busca com maior precisão.

Ressalta-se que na IPC não há qualquer subdivisão entre [A47K 3/00](#) e [A47K 3/02](#), ao contrário do que ocorre na CPC.

ation (IPC) Official Publication

IPC

PROPERTY ORGANIZATION			
Scheme	RCL	Compilation	Guide to the IPC
<input type="checkbox"/>	A47K 3/00	Baths; Showers; Appurtenances therefor (for curative purposes A61H , A61M , e.g. bathing device	
<input type="checkbox"/>	A47K 3/02	• Baths (combined with showers A47K 3/20 ; heatable F24H) [2006.01]	
<input type="checkbox"/>	A47K 3/022	•• specially adapted for particular use, e.g. for washing the feet, for bathing in sitting position (collap	
<input type="checkbox"/>	A47K 3/024	••• specially adapted for use for children or babies [2006.01]	
<input type="checkbox"/>	A47K 3/03	•• attachable to other baths, sinks, wash-basins, or the like (collapsible baths A47K 3/07) [2006.01]	
<input type="checkbox"/>	A47K 3/034	••• specially adapted for use for children or babies [2006.01]	
<input type="checkbox"/>	A47K 3/04	•• Built-in baths [2006.01]	

Selecionando o botão “CPC” abaixo, ficam marcados os aspectos nos quais a CPC se diferencia da IPC (em verde e entre chaves { }, referentes às classificações que pertencem somente à CPC):

« A47K1/00 A47K4/00 »

Symbol	Classification and description
★★★★★ <input type="checkbox"/> A47K 3/00	Baths; Douches; Appurtenances therefor (for curative purposes A61H, A61M , e.g. bathing devices for special therapeutic or hygienic purposes A61H 33/00 ; {spray heads B05B ; devices for suspending or supporting the supply pipe or supply hose of a shower bath E03C 1/06 ; heated bath tubs F24H 1/0072 })
<input type="checkbox"/> A47K 3/001	• {Accessories for baths, not provided for in other subgroups of group A47K 3/00 (bath lifting devices for sick persons and invalids A61G 7/10); Insertions, e.g. for babies; Tubs suspended or inserted in baths; Security or alarm devices; Protecting linings or coverings; Devices for cleaning or disinfecting baths; Bath insulation}
<input type="checkbox"/> A47K 3/002	•• {Non-slip mats for baths}
<input type="checkbox"/> A47K 3/003	•• {Grips for baths}
<input type="checkbox"/> A47K 3/004	•• {Trays}
<input type="checkbox"/> A47K 3/005	•• {Tap covers for protection against injury}
<input type="checkbox"/> A47K 3/006	•• {Doors to get in and out of baths more easily}
<input type="checkbox"/> A47K 3/007	•• {Tipping-devices for baths}
<input type="checkbox"/> A47K 3/008	•• {Sealing between wall and bathtub or shower tray}
<input type="checkbox"/> A47K 3/02	• Baths (heatable F24H)
<input type="checkbox"/> A47K 3/022	•• specially adapted for particular use, e.g. for washing the feet, for bathing in sitting position ({doors to get in and out of baths more easily A47K 3/006 }; collapsible baths A47K 3/062)
<input type="checkbox"/> A47K 3/024	••• specially adapted for use for children or babies
<input type="checkbox"/> A47K 3/03	•• attachable to other baths, sinks, wash-basins, or the like {mounting frames for therefor} (collapsible baths A47K 3/07)
<input type="checkbox"/> A47K 3/034	••• specially adapted for use for children or babies
<input type="checkbox"/> A47K 3/04	•• Built-in baths {(A47K 3/16 takes precedence)}

Classificação de um objeto de busca na CPC, usando duas palavras- chave

Exemplo 2 - berço

Determinação da classificação de um berço (qualquer modelo):



Fotos e figuras obtidas na internet. Clique na imagem para acessar o link.

Usando soemente o termo “cradle” (berço), as classificações sugeridas não são apropriadas, pois o termo tem vários significados em inglês.

Cooperative Patent Classification

Search for **cradle** Search View section | Index | A | B | C | D | E | F | G | H | Y |

« A47L2601/00 A61B »

Symbol	Classification and description
▼ ★★★★★ <input type="checkbox"/> G06F 1/00	Details of data-processing equipment not covered by groups G06F 3/00 to G06F 13/00 , { e.g. cooling, packaging or power supply specially adapted for computer application (security arrangements for protecting computers or computer systems against unauthorised activity G06F 21/00)}
▼ ★★★★★ <input type="checkbox"/> F16M 11/00	Stands or trestles as supports for apparatus or articles placed thereon {Stands for scientific apparatus such as gravitational force meters} (without heads F16K 13/00 ; easels or stands for blackboard or the like A47B 97/04 ; show-stands A47F 7/00 ; for workmen E04G 1/32 ; { sockets or holders for poles or posts E04H 12/22 }; supporting, suspending for lighting devices F21V 21/00 ; special modifications for particular apparatus or articles, see the appropriate subclasses)
▼ ★★★★★★ <input type="checkbox"/> A61B 5/00	Detecting, measuring or recording for diagnostic purposes (radiation diagnosis A61B 6/00 ; diagnosis by ultrasonic, sonic or infrasonic waves A61B 8/00); Identification of persons { (measuring or recording in general subclasses of G01 ; medical informatics G06F 19/30)}
▼ ★★★★★★ <input type="checkbox"/> H04M 1/00	Substation equipment, e.g. for use by subscribers; Analogous equipment at exchanges (prepayment telephone coin boxes H04M 17/00 ; current supply arrangements H04M 19/00 ; { telephone sets particularly adapted for data transmission H04M 11/066 ; network interface devices H04Q 1/028)}
▼ ★★★★★★ <input type="checkbox"/> H04B 1/00	Details of transmission systems, not covered by a single one of groups H04B 3/00 to H04B 13/00 ; Details of transmission systems not characterised by the medium used for transmission (tuning resonant circuits H03J)
▼ ★★★★★★ <input type="checkbox"/> F16M 13/00	Other supports for positioning apparatus or articles (heads thereof F16M 11/02 ; { undercarriages thereof F16M 11/20 }; adapted to be stuck in the ground A45F 3/44 ; { sockets or holders for poles or posts E04H 12/22 }); Means for steadying hand-held apparatus or articles {(supports for measuring instruments G01D 11/30 ; supports for casings of remote control switching devices H01H 9/025)}
▼ ★★★★★★ <input type="checkbox"/> B60R 11/00	Arrangements for holding or mounting articles, not otherwise provided for
▼ ★★★★★★ <input type="checkbox"/> B29C 63/00	Lining or sheathing, i.e. applying preformed layers or sheathing of plastics; Apparatus therefor (B29C 73/00 takes precedence; by blowing B29C 49/00 ; by thermoforming B29C 51/00)

Entretanto, aqui pode ser usado mais de um termo: usando a combinação “baby cradle” (berço para bebê), obtém-se resultados pertinentes, como a classificação **A47D 9/00**.

Search for **baby cradle**

View section | [Index](#) | [A](#) | [B](#) | [C](#) | [D](#) | [E](#) | [F](#) | [G](#) | [H](#) | [Y](#)



« [A47L2601/00](#) [A61B](#) »

Symbol	Classification and description
▼ ★★★★★	<input type="checkbox"/> A47D 9/00 {Small beds for newborns or infants, e.g. bassinets or} cradles
▼ ★★★★★	<input type="checkbox"/> A47D 15/00 Accessories for children's furniture, e.g. safety belts (holders for { baby bottles or} bottles for medicinal feeding A61J 9/06 ; safety belts or body harnesses, in general A62B 35/00 ; { infant exercisers attachable to play-pens, beds or cradles A63H 33/006 }; safety belts or body harnesses in land vehicles B60R 22/00 ; harnessing in aircraft B64D 25/06)
▼ ★★★★★★	<input type="checkbox"/> A47D 1/00 Children's chairs (chairs generally A47C)
▼ ★★★★★★	<input type="checkbox"/> A47D 13/00 Other nursery furniture (auxiliary or portable toilet seats for children A47K 13/06)
▼ ★★★★★★	<input type="checkbox"/> A47D 7/00 Children's beds (beds in general A47C)
▼ ★★★★★★	<input type="checkbox"/> H04N 7/00 Television systems (details H04N 3/00 , H04N 5/00 ; methods or arrangements, for coding, decoding, compressing or decompressing digital video signals H04N 19/00 ; selective content distribution H04N 21/00)
▼ ★★★★★★	<input type="checkbox"/> F21V 21/00 Supporting, suspending, or attaching arrangements for lighting devices (F21V 17/00 , F21V 19/00 take precedence; arrangement of signalling or lighting devices, the mounting or supporting thereof or circuits therefor, for vehicles in general B60Q , stands for supporting apparatus or articles in general F16M 11/00); Hand grips
▼ ★★★★★★	<input type="checkbox"/> A63H 33/00 Other toys
▼ ★★★★★★	<input type="checkbox"/> A47G 33/00 Religious or ritual equipment in dwelling or for general use

Clicando na classificação **A47D 9/00**, são apresentadas classificações mais detalhadas. Cumpre ressaltar que a classificação **A47D 9/005**, marcada em verde, faz parte da CPC, mas não da CIP.

Symbol	Classification and description
★★★★★	<input type="checkbox"/> A47D 9/00 {Small beds for newborns or infants, e.g. bassinets or} cradles
	<input type="checkbox"/> A47D 9/005 • {foldable}
	<input type="checkbox"/> A47D 9/02 • with rocking mechanisms (devices for moving perambulators to and from <u>B62B 9/22</u>)
	<input type="checkbox"/> A47D 9/04 • • with disconnectable rockers

Como o modelo de berço não foi especificado, a classificação A47D 9/00 poderá ser atribuída, genericamente. Para uma classificação precisa, mais detalhes do berço deverão ser apresentados.

Recuperação de documentos de patente numa determinada classificação, no esquema da CPC

Exemplo 3 – berço dobrável

Demonstração de como localizar patentes na classificação de berços dobráveis, como este abaixo, usando o portal do esquema da CPC.



Foto obtida na internet. Clique na imagem para acessar o link.

A classificação de berço dobrável na CPC foi apresentada no exemplo anterior: **A47D 9/005**.

Symbol	Classification and description
★★★★★★	<input type="checkbox"/> A47D 9/00 {Small beds for newborns or infants, e.g. bassinets or} cradles
	<input type="checkbox"/> A47D 9/005 • {foldable}
	<input type="checkbox"/> A47D 9/02 • with rocking mechanisms (devices for moving perambulators to and from <u>B62B 9/22</u>)
	<input type="checkbox"/> A47D 9/04 • • with disconnectable rockers

Esta classificação poderia ser encontrada como anteriormente, com os termos “baby cradle”, ou com “foldable cradle”, por exemplo.

Os documentos de patente na classificação **A47D 9/005**, referente a berços dobráveis, podem ser recuperados através do seguinte recurso da CPC:

Smart search
Advanced search
Classification search

Quick help

- [What is the Cooperative Patent Classification system?](#)
- [How do I enter classification symbols?](#)
- [What do the different buttons mean?](#)
- [Can I retrieve a classification using keywords?](#)
- [Can I start a new search using the classifications listed?](#)
- [Where can I view the description of a particular CPC class?](#)
- [What is the meaning of the stars in front of the classifications found?](#)
- [What does the text in brackets mean?](#)

Cooperative Patent Classification

Search for View section | Index **A** | B | C | D | E | F

« A47D7/00 »

Symbol	Classification and description
<input type="checkbox"/> A	HUMAN NECESSITIES
Personal or domestic articles	
<input type="checkbox"/> A47	FURNITURE (arrangements of seats for, or adaptations of seats to, vehicles B60N); DOMESTIC ARTICLES OR APPLIANCES; COFFEE MILLS; SPICE MILLS; SUCTION CLEANERS IN GENERAL (ladders E06C)
<input type="checkbox"/> A47D	FURNITURE SPECIALLY ADAPTED FOR CHILDREN (school benches or desks A47B 39/00 , A47B 41/00)
<input checked="" type="checkbox"/> A47D 9/00	{Small beds for newborns or infants, e.g. bassinets or} cradles
<input type="checkbox"/> A47D 9/005	• {foldable}

Selected classifications
nothing selected

o botão “Find patents” permite encontrar os documentos de patente que possuem a(s) classificação(ões) selecionada(s).

Para tal, é necessário selecionar ao menos uma classificação:

- [What is the Cooperative Patent Classification system?](#)
- [How do I enter classification symbols?](#)
- [What do the different buttons mean?](#)
- [Can I retrieve a classification using keywords?](#)
- [Can I start a new search using the classifications listed?](#)
- [Where can I view the description of a particular CPC class?](#)
- [What is the meaning of the stars in front of the classifications found?](#)
- [What does the text in brackets mean?](#)

Symbol	Classification and description
<input type="checkbox"/> A	HUMAN NECESSITIES
	Personal or domestic articles
<input type="checkbox"/> A47	FURNITURE (arrangements of seats for, or adaptations of seats to, vehicles B60N); DOMESTIC ARTICLES OR APPLIANCES; COFFEE MILLS; SPICE MILLS; SUCTION CLEANERS IN GENERAL (ladders E06C)
<input type="checkbox"/> A47D	FURNITURE SPECIALLY ADAPTED FOR CHILDREN (school benches or desks A47B 39/00 , A47B 41/00)
▲ <input type="checkbox"/> A47D 9/00	{Small beds for newborns or infants, e.g. bassinets or} cradles
<input checked="" type="checkbox"/> A47D 9/005	• {foldable}

Selected classifications
 /low
Clear

ao clicar na caixa ao lado da classificação, a mesma surge na lista de classificações selecionadas, em “Selected classifications”.

O termo “/low” significa que os documentos de patente em classificações hierarquicamente subordinadas a esta também serão recuperados.

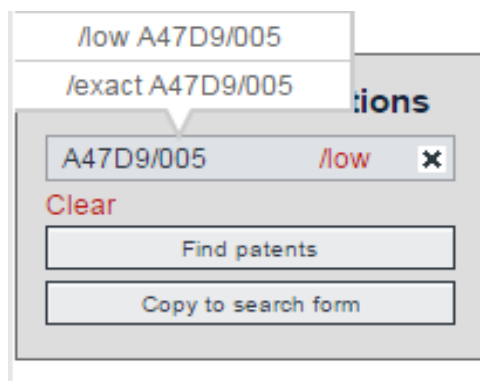

The screenshot shows a search interface with a dropdown menu for classification options. The dropdown is open, showing two options: "/low A47D9/005" and "/exact A47D9/005". Below the dropdown, the text "A47D9/005" is entered in a search box, followed by the selected option "/low" and a clear button "x". Below the search box, there are two buttons: "Find patents" and "Copy to search form".

Esta escolha pode ser alterada com o cursor e um clique para “/exact”, opção em que somente os documentos desta classificação exata serão recuperados.

No caso da classificação **A47D 9/005**, não há outras classificações subordinadas a esta, portanto qualquer uma das opções retornará os mesmos documentos.

Clicando em “Find patents”, foram obtidos 617 resultados, com classificação CPC igual a **A47D 9/005**. Como a classificação é específica para berços dobráveis, os documentos recuperados são relacionados a este tipo de berço ou a acessórios para o mesmo.

Approximately 617 results found in the Worldwide database for: **A47D9/005/low** as the Cooperative Patent Classification
Only the first 500 results are displayed.

Busca realizada em março de 2016.

1 ▶

Results are sorted by date of upload in database

1. **PLAY YARD WITH REMOVABLE LINER**

★	Inventor:	Applicant:	CPC:	IPC:	Publication info:	Priority date:
	RONG ZHANG XING [CN] BURNS STEPHEN R [US]	KIDS II INC [US]	<u>A47D13/06</u> <u>A47D13/061</u> <u>A47D13/063</u> (+2)	A47D13/06 A47D15/00	US2016066706 (A1) 2016-03-10	2012-02-08

2. **BABY SEAT**

★	Inventor:	Applicant:	CPC:	IPC:	Publication info:	Priority date:
	WINDENBERGER LAURENT [FR]	A L T PARTNERS [FR]	<u>A47D1/004</u> A47D9/005	A47D1/00 A47D1/04	CA2899613 (A1) 2016-02-08	2014-08-08

No item 1, a referida classificação A47D 9/005 não aparece na tela pois está entre as 2 classificações adicionais indicadas por (+2).

A busca de patentes também pode ser feita no Espacenet, por exemplo na busca avançada.



Smart search
Advanced search
Classification search

Quick help

- [What is the Cooperative Patent Classification system?](#)
- [How do I enter classification symbols?](#)
- [What do the different buttons mean?](#)
- [Can I retrieve a classification using keywords?](#)
- [Can I start a new search using the classifications listed?](#)
- [Where can I view the description of a particular CPC class?](#)
- [What is the meaning of the stars in front of the classifications found?](#)
- [What does the text in brackets mean?](#)

Cooperative Patent Classification

Search for

Search

View section | Index **A** | B | C | D | E | F | G | H | Y

← → [Grid] [List] [Info] **CPC** [Grid] [...] [2x0] [2000]

« A47D7/00 A47D11/00 »

Symbol	Classification and description	
<input type="checkbox"/> A	HUMAN NECESSITIES	
Personal or domestic articles		
<input type="checkbox"/> A47	FURNITURE (arrangements of seats for, or adaptations of seats to, vehicles B60N); DOMESTIC ARTICLES OR APPLIANCES; COFFEE MILLS; SPICE MILLS; SUCTION CLEANERS IN GENERAL (ladders E06C)	
<input type="checkbox"/> A47D	FURNITURE SPECIALLY ADAPTED FOR CHILDREN (school benches or desks A47B 39/00 , A47B 41/00)	
<input type="checkbox"/> A47D 9/00	{Small beds for newborns or infants, e.g. bassinets or} cradles	
<input type="checkbox"/> A47D 9/005	• {foldable}	

- Smart search
- Advanced search**
- Classification search

Quick help -

- [How many search terms can I enter per field?](#)
- [How do I enter words from the title or abstract?](#)
- [How do I enter words from the description or claims?](#)
- [Can I use truncation/wildcards?](#)
- [How do I enter publication, application, priority and NPL reference numbers?](#)
- [How do I enter the names of persons and organisations?](#)
- [What is the difference between the IPC and the CPC?](#)
- [What formats can I use for the publication date?](#)
- [How do I enter a date range for a publication date search?](#)
- [Can I save my query?](#)

Related links +

Advanced search

Select the collection you want to search in [i](#)

Enter your search terms - CTRL-ENTER expands the field you are in

Enter keywords in English

Title: [i](#)

Title or abstract: [i](#)

Enter numbers with or without country code

Publication number: [i](#)

Application number: [i](#)

Priority number: [i](#)

Enter one or more dates or date ranges

Publication date: [i](#)

Enter name of one or more persons/organisations

Applicant(s): [i](#)

Inventor(s): [i](#)

Enter one or more classification symbols

CPC [i](#)

IPC [i](#)

Observar que os campos CPC e IPC estão presentes na busca avançada.



O campo CPC pode ser utilizado para recuperar documentos de patente referentes a berços dobráveis, para a classificação **A47D 9/005** :

Enter one or more classification symbols

CPC

A47D9/005

IPC

Obs: a classificação **A47D 9/005** não pode ser usada no campo IPC, pois a mesma não faz parte da Classificação Internacional de Patentes.

Desta forma, foram obtidos 617 resultados, com classificação CPC igual a **A47D 9/005**. Estes resultados são compatíveis aos obtidos anteriormente, através do botão “Find patents”.

Approximately **617** results found in the Worldwide database for: **A47D9/005** as the Cooperative Patent Classification
Only the first **500** results are displayed.

Busca realizada em março de 2016.

1 ▶

Results are sorted by date of upload in database

1. PLAY YARD WITH REMOVABLE LINER

★	Inventor: RONG ZHANG XING [CN] BURNS STEPHEN R [US]	Applicant: KIDS II INC [US]	CPC: <u>A47D13/06</u> <u>A47D13/061</u> <u>A47D13/063</u> (+2)	IPC: A47D13/06 A47D15/00	Publication info: US2016066706 (A1) 2016-03-10	Priority date: 2012-02-08
---	--	---------------------------------------	---	---------------------------------------	---	-------------------------------------

2. BABY SEAT

★	Inventor: WINDENBERGER LAURENT [FR]	Applicant: A L T PARTNERS [FR]	CPC: <u>A47D1/004</u> A47D9/005	IPC: A47D1/00 A47D1/04	Publication info: CA2899613 (A1) 2016-02-08	Priority date: 2014-08-08
---	--	--	---	-------------------------------------	--	-------------------------------------

3. METHOD AND DEVICE FOR ESTABLISHING A PLACE OF REST FOR SMALL CHILDREN

★	Inventor: HOLMGREN HALVOR [NO]	Applicant: JETKIDS AS [NO]	CPC: <u>A45C9/00</u> <u>A47C17/82</u> A47D9/005	IPC: A45F4/06 A47C17/82	Publication info: NO20140682 (A) 2015-12-03 NO337197 (B1)	Priority date: 2014-06-02
---	---	--------------------------------------	--	--------------------------------------	---	-------------------------------------

Classificação Y de um objeto de busca

Exemplo 4 – gerador eólico

Determinação da classificação Y, da CPC, para um “gerador eólico adaptado em uma plataforma offshore” (qualquer estrutura):



Fotos e figuras obtidas na internet. Clique na imagem para acessar o link.

Usando a expressão “offshore turbine”, são propostas as seguintes classificações:

Cooperative Patent Classification

Search for **offshore turbine**

[View section](#) | [Index](#) | [A](#) | [B](#) | [C](#) | [D](#) | [E](#) | [F](#) | [G](#) | [H](#) | [Y](#)







A »

Symbol	Classification and description
▼ ★★☆☆★	<input type="checkbox"/> Y02E 10/00 Energy generation through renewable energy sources
▼ ★★☆☆★	<input type="checkbox"/> F03D 11/00 Details, component parts, or accessories not provided for in, or of interest apart from, the preceding groups
▼ ★★☆☆★	<input type="checkbox"/> F03D 1/00 Wind motors with rotation axis substantially in wind direction (controlling F03D 7/00)
▼ ★★☆☆★	<input type="checkbox"/> B63B 35/00 Vessels or like floating structures adapted for special purposes (vessels characterised by load-accommodating arrangements B63B 25/00 ; fire-fighting vessels A62C 29/00 ; submarines, mine-layers or mine-sweepers B63G ; large containers for use in or under water B65D 88/78 ; { Advertising on ships or other floating means G09F 21/18 })
▼ ★★☆☆★	<input type="checkbox"/> E02D 27/00 Foundations as substructures
▼ ★★☆☆★	<input type="checkbox"/> F03D 7/00 Controlling wind motors
▼ ★★☆☆★	<input type="checkbox"/> F03D 9/00 Adaptations of wind motors for special use; Combinations of wind motors with apparatus driven thereby (aspects predominantly concerning driven apparatus)

Todas as classificações propostas têm relação com turbinas eólicas.

Após a leitura detalhada das subclassificações subordinadas a **Y02E 10/00** da CPC, seleciona-se a classificação **Y02E 10/727** como apropriada para o objeto buscado:

Symbol	Classification and description		
<input type="checkbox"/> Y	GENERAL TAGGING OF NEW TECHNOLOGICAL DEVELOPMENTS; GENERAL TAGGING OF CROSS-SECTIONAL TECHNOLOGIES SPANNING OVER SEVERAL SECTIONS OF THE IPC; TECHNICAL SUBJECTS COVERED BY FORMER USPC CROSS-REFERENCE ART COLLECTIONS [XRACs] AND DIGESTS		
<input type="checkbox"/> Y02	TECHNOLOGIES OR APPLICATIONS FOR MITIGATION OR ADAPTATION AGAINST CLIMATE CHANGE		
<input type="checkbox"/> Y02E	REDUCTION OF GREENHOUSE GASES [GHG] EMISSION, RELATED TO ENERGY GENERATION, TRANSMISSION OR DISTRIBUTION		
<input type="checkbox"/> Y02E 10/00	Energy generation through renewable energy sources		
<input type="checkbox"/> Y02E 10/70	• Wind energy		
<input type="checkbox"/> Y02E 10/72	•• Wind turbines with rotation axis in wind direction		
<input type="checkbox"/> Y02E 10/727	••• Offshore towers		

O documento ao lado refere-se a um gerador eólico em plataforma.

Observa-se que a classificação selecionada está presente, acompanhando outras classificações que se referem às características específicas do gerador eólico descrito.

FLOATING OFFSHORE WIND POWER GENERATION FACILITY

Page bookmark [WO2014141911 \(A1\) - FLOATING OFFSHORE WIND POWER GENERATION FACILITY](#)

Inventor(s): SATO IKU [JP]; ASANO HITOSHI [JP]; UTSUNOMIYA TOMOAKI [JP]; YOSHIDA SHIGEO [JP] ±

Applicant(s): TODA CORP [JP]; UNIV KYOTO [JP]; HITACHI LTD [JP] ±

Classification: - international: *F03D11/04*; *F03D9/00*

- cooperative: *F03D11/04*; *F03D11/045*; *F05B2240/93*; *F05B2240/95*; *Y02E10/726*; *Y02E10/727*

Application number: **WO**2014JP55228 20140303

Priority number(s): [JP20130050180](#) [20130313](#)

Also published as: 📄 [TW201508171 \(A\)](#) 📄 [JP2014173586 \(A\)](#)

Abstract of WO2014141911 (A1)

Translate this text into



↔ **patenttranslate** powered by EPO and Google

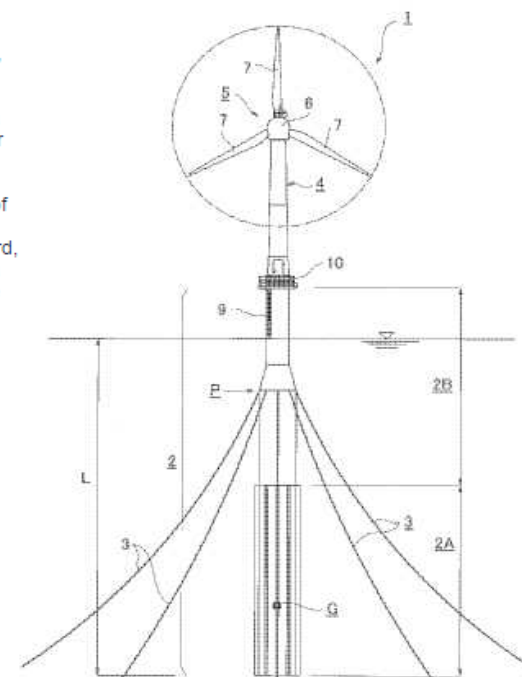



[Problem] To make it possible to, in a spar type floating offshore wind power generation facility, suppress a reduction in power generation efficiency due to tilting of a tower, suppress rotational motion (yaw motion) around a vertical axis, prevent a ship from coming into contact with a mooring cable, and at the same time appropriately hold the tilted posture state of the tower. [Solution] A floating offshore wind power generation facility (1) configured from a floating body (2), a mooring cable (3), a tower (4), and a windmill (5) installed at the top of the tower (4) and composed of a nacelle (6) and a plurality of blades (7), wherein the rotation axis of the windmill (5) has a predetermined upward angle in order to avoid contact between the blades (7) and the tower (4), and the windmill (5) is of a downwind type in which the blades (7) are attached to the leeward side of the nacelle (6) and installed with the back surfaces of the blades (7) facing windward, and the mooring point of the mooring cable (3) to the floating body (2) is set at a position below the surface of the sea and higher than the center of gravity of the floating body (2).



Considerações Finais

Descrição detalhada das classificações da CPC

Para detalhes da classificação, clicar na classificação desejada (**Y**, no exemplo abaixo). Para mais informações, clicar em  (que abre um arquivo em pdf) ou em , como segue:

<input type="checkbox"/> Y	GENERAL TAGGING OF NEW TECHNOLOGICAL DEVELOPMENTS; GENERAL TAGGING OF CROSS-SECTIONAL TECHNOLOGIES SPANNING OVER SEVERAL SECTIONS OF THE IPC; TECHNICAL SUBJECTS COVERED BY FORMER USPC CROSS-REFERENCE ART COLLECTIONS [XRACs] AND DIGESTS	 
Notes		
 1. In this section, classes Y02 and Y04 are only to be used for tagging documents which are already classified or indexed elsewhere and which relate in a broad sense to specific major technical fields, these fields being defined by the notes following the title of the subclasses of this section.		
2. As the primary purpose of the tagging according to Note (1) is to monitor new technological development and to tag cross-sectional technologies that do not fit in a single other section of the IPC, the tagging codes of this section do not in any way replace the classification or indexing codes of the other sections.		
3. Class Y10 has been introduced in July 2012 in view of the CPC to accommodate for technical subjects formerly covered by USPC cross-reference art collections [XRACs] and digests		
<input type="checkbox"/> Y02	TECHNOLOGIES OR APPLICATIONS FOR MITIGATION OR ADAPTATION AGAINST CLIMATE CHANGE	
<input type="checkbox"/> Y04	INFORMATION OR COMMUNICATION TECHNOLOGIES HAVING AN IMPACT ON OTHER TECHNOLOGY AREAS	
<input type="checkbox"/> Y10	TECHNICAL SUBJECTS COVERED BY FORMER USPC	

Mais uma comparação entre a CPC e a IPC

Nem todas as classificações da IPC fazem parte da CPC. Por exemplo:

A61N **ELECTROTHERAPY; MAGNETOTHERAPY; RADIATION THERAPY; ULTRASOUND THERAPY** (measurement of bioelectric currents **A61B**; surgical instruments, devices or methods for transferring non-mechanical forms of energy to or from the body **A61B 18/00**; anaesthetic apparatus in general **A61M**; incandescent lamps **H01K**; infra-red radiators for heating **H05B**) [6]

Note(s) [7]

In this subclass, the following term is used with the meaning indicated:

- "therapy" implies that the **treatment**, when it aims at destroying sick or abnormal cells, is performed within the limits of healthy cell life, the destruction undesired, contrary to that which takes place with instruments, devices or methods covered by group **A61B 18/00**.

A61P **SPECIFIC THERAPEUTIC ACTIVITY OF CHEMICAL COMPOUNDS OR MEDICINAL PREPARATIONS** [7]

Note(s) [2012.01]

1. This subclass covers therapeutic activity of **chemical compounds** or medicinal **preparations** already classified as such in subclasses **A61K** or **C12N**, or **C07** or **C08**.
2. In this subclass, the term "**drugs**" includes **chemical compounds** or compositions with therapeutic activity.
3. In this subclass, therapeutic activity is classified in all appropriate places.
4. Attention is drawn to cases where the subject of the invention concerns only specific therapeutic activity of **chemical compounds** or medical **preparations** chemical structure, compound, mixture or composition of this subject of the invention is known. In such cases, classification is made in both subclass **A61P** and subclass **A61P** as invention information. In addition, if the chemical structure, compound, mixture or composition or any individual ingredient of a mixt composition is considered to represent information **of interest** for search, it may also be classified as additional information
5. The classification symbols of this subclass are not listed first when assigned to patent documents.

A61Q **SPECIFIC USE OF COSMETICS OR SIMILAR TOILET PREPARATIONS** [2006.01]

IPC

a classificação **A61P** (Atividade Terapêutica de Compostos Químicos ou de Preparações Medicinais), presente na IPC, não existe na CPC.

CPC

A61N

ELECTROTHERAPY; MAGNETOTHERAPY; RADIATION THERAPY; ULTRASOUND THERAPY (measurement of bioelectric currents **A61B**; surgical instruments, devices or methods for transferring non-mechanical forms of energy to or from the body **A61B 18/00**; anaesthetic apparatus in general **A61M**; incandescent lamps **H01K**; infra-red radiators for heating **H05B**)

A61Q

SPECIFIC USE OF COSMETICS OR SIMILAR TOILET PREPARATIONS

Conclusões

- Buscas de patentes usando a CPC podem render bons resultados, devido à classificação mais específica. Por exemplo, a busca em documentos dos EUA e da EPO é mais eficiente usando a CPC, do que a IPC, por terem sua documentação completa classificada pela CPC.
- Porém, como somente parte dos documentos nas bases internacionais (como o Espacenet) está classificada pela CPC, para levantamentos e buscas completas devem ser usadas tanto a CPC como a IPC.
- Tecnologias emergentes são identificadas na CPC pelas classificações Y, que são complementares e sempre acompanham as classificações das outras seções, referentes à área específica da invenção.

Classificação Cooperativa de Patentes

A CPC pode ser consultada na Internet:

- somente em inglês - via site do Escritório Europeu de Patentes

http://worldwide.espacenet.com/classification?locale=en_EP

Material elaborado pelo

Coordenação Geral de Estudos Projetos e Difusão de Informação Tecnológica –
CEPIT

Dúvidas referentes à classificação pela CPC podem ser encaminhadas a
classifica@inpi.gov.br



www.inpi.gov.br

Dúvidas deverão ser enviadas para o “Faleconosco”

<http://faleconosco.inpi.gov.br/faleconosco/>