

FLUKE®

8508A

Digital Reference Multimeter

Users Manual

PN 1673798

July 2002 Rev. 3, 3/06

© 2002-2006 Fluke Corporation, All rights reserved. Printed in UK
All product names are trademarks of their respective companies.

LIMITED WARRANTY AND LIMITATION OF LIABILITY

Each Fluke product is warranted to be free from defects in material and workmanship under normal use and service. The warranty period is one year and begins on the date of shipment. Parts, product repairs, and services are warranted for 90 days. This warranty extends only to the original buyer or end-user customer of a Fluke authorized reseller, and does not apply to fuses, disposable batteries, or to any product which, in Fluke's opinion, has been misused, altered, neglected, contaminated, or damaged by accident or abnormal conditions of operation or handling. Fluke warrants that software will operate substantially in accordance with its functional specifications for 90 days and that it has been properly recorded on non-defective media. Fluke does not warrant that software will be error free or operate without interruption.

Fluke authorized resellers shall extend this warranty on new and unused products to end-user customers only but have no authority to extend a greater or different warranty on behalf of Fluke. Warranty support is available only if product is purchased through a Fluke authorized sales outlet or Buyer has paid the applicable international price. Fluke reserves the right to invoice Buyer for importation costs of repair/replacement parts when product purchased in one country is submitted for repair in another country.

Fluke's warranty obligation is limited, at Fluke's option, to refund of the purchase price, free of charge repair, or replacement of a defective product which is returned to a Fluke authorized service center within the warranty period.

To obtain warranty service, contact your nearest Fluke authorized service center to obtain return authorization information, then send the product to that service center, with a description of the difficulty, postage and insurance prepaid (FOB Destination). Fluke assumes no risk for damage in transit. Following warranty repair, the product will be returned to Buyer, transportation prepaid (FOB Destination). If Fluke determines that failure was caused by neglect, misuse, contamination, alteration, accident, or abnormal condition of operation or handling, including overvoltage failures caused by use outside the product's specified rating, or normal wear and tear of mechanical components, Fluke will provide an estimate of repair costs and obtain authorization before commencing the work. Following repair, the product will be returned to the Buyer transportation prepaid and the Buyer will be billed for the repair and return transportation charges (FOB Shipping Point).

THIS WARRANTY IS BUYER'S SOLE AND EXCLUSIVE REMEDY AND IS IN LIEU OF ALL OTHER WARRANTIES, EXPRESS OR IMPLIED, INCLUDING BUT NOT LIMITED TO ANY IMPLIED WARRANTY OF MERCHANTABILITY OR FITNESS FOR A PARTICULAR PURPOSE. FLUKE SHALL NOT BE LIABLE FOR ANY SPECIAL, INDIRECT, INCIDENTAL, OR CONSEQUENTIAL DAMAGES OR LOSSES, INCLUDING LOSS OF DATA, ARISING FROM ANY CAUSE OR THEORY.

Since some countries or states do not allow limitation of the term of an implied warranty, or exclusion or limitation of incidental or consequential damages, the limitations and exclusions of this warranty may not apply to every buyer. If any provision of this Warranty is held invalid or unenforceable by a court or other decision-maker of competent jurisdiction, such holding will not affect the validity or enforceability of any other provision.

Fluke Corporation
P.O. Box 9090
Everett, WA 98206-9090
U.S.A.

Fluke Europe B.V.
P.O. Box 1186
5602 BD Eindhoven
The Netherlands

11/99

To register your product online, visit register.fluke.com

Table of Contents

Chapter	Title	Page
1	Introduction and Safety Information.....	1-1
	Introduction.....	1-3
	Contacting Fluke.....	1-3
	Unpacking and Inspection.....	1-3
	Standard Accessories.....	1-4
	Optional Accessories.....	1-4
	Storing and Shipping the Multimeter.....	1-5
	Line Voltage.....	1-5
	Power Voltage Selector and Fuses.....	1-5
	Changing Line Fuse or Supply Voltage Only.....	1-5
	Calibration Enable Switch.....	1-6
	System Use.....	1-6
	Safety Considerations and Symbols.....	1-6
	General Safety Summary.....	1-6
	Symbols.....	1-8
	Protection Class I.....	1-9
	Protective Earth/Ground.....	1-9
	Do Not Operate Without Covers.....	1-9
	Safe Operating Conditions.....	1-9
	Fuse Requirements.....	1-10
	Rear Panel Detail.....	1-10
	The Power Cable and Power Supply Disconnection.....	1-10
	Terminal Connections.....	1-11
	Installation/Measurement Category I.....	1-11
	Maintenance and Repair.....	1-11
	Moving and Cleaning.....	1-11
2	Getting Acquainted with the Basics.....	2-1
	Introduction.....	2-3
	Input Terminals.....	2-3
	The Front Panel Displays.....	2-4
	Front Panel Keys.....	2-4
	Soft-Keys and Manual Conventions.....	2-4
	Numeric Keyboard.....	2-5

Exiting a Menu	2-5
Major Function Keys	2-5
Direct Action Keys	2-6
Mode Keys	2-6
Rear Panel	2-7
Labels	2-7
Fuses	2-7
Voltage Selector	2-7
Power Input and Power Switch	2-7
Calibration Switch	2-7
Rear Panel Connectors and Pin Designations	2-8
Rear Inputs	2-8
External Trigger Input	2-8
IEEE 488 Input/Output	2-8
Power-On Configuration	2-8
The 8508A-LEAD Measurement Lead Kit	2-9

3 Making Measurements 3-1

Introduction	3-3
Making Connections to the Multimeter -- General Guidelines	3-4
Using the Measurement Functions	3-5
DC Voltage	3-5
Measuring DC Voltage	3-7
Making Input Connections	3-7
AC Voltage	3-8
Measuring AC Voltage	3-11
Induced Interference	3-11
Common Mode Rejection	3-11
Lead Considerations	3-11
Resistance	3-11
High Voltage Ohms	3-13
True Ohms	3-15
Measuring Resistance	3-16
2-Wire Measurements	3-16
4-wire Measurements	3-17
4-wire High Resistance Measurements	3-17
4-wire Resistance Zero	3-18
Ω Guard	3-18
DC Current	3-20
Measuring DC Current	3-21
AC Current	3-22
Measuring AC Current	3-23
Temperature	3-24
Measuring Temperature	3-27
Multimeter Inputs	3-28
Input	3-28
Using the INPUT Key	3-28
SCAN OPERATIONS	3-29
Tru Ohms Ratio	3-30
Monitoring Modes	3-31
Monitor Key	3-31
Displaying Signal Frequency	3-31
Displaying Standard Deviation	3-31
Devn Menu	3-31

Displaying Maximum, Minimum, and Peak-to-Peak Readings	3-32
MAX Menu	3-32
Limit-Checking	3-32
Monitor Menu Tree	3-33
Utility	3-33
Using the Selftest Functions	3-36
Test Menu Tree	3-36
Test Key	3-37
Using the Math Functions	3-38
Math Functions and Menu Tree	3-38
Math Configuration	3-39
Clear Functions	3-40
4 Remote Operations Using the IEEE 488 Interface	4-1
Introduction	4-3
Interface Capability: IEEE Standards 488.1 and 488.2	4-3
The Multimeter in IEEE 488.2 Terminology	4-3
Programming Options	4-3
Capability Codes	4-3
Interconnections	4-4
Using the 8508A Reference Multimeter in a System	4-5
Setting the Multimeter Address	4-5
Remote Operation General Considerations	4-5
Syntax Diagrams in this Manual	4-5
The 8508A Status Reporting Structure	4-8
Types of Status Information Available	4-9
Syntax Diagrams of Major 8508A Functions	4-10
DC Voltage	4-10
AC Voltage	4-11
Resistance: Normal OHMS	4-13
Resistance: High Voltage OHMS	4-14
Resistance: True OHMS	4-15
DC Current	4-16
AC Current	4-17
Using Platinum Resistance Thermometers to obtain Temperature	4-18
Determine the PRT identity	4-18
Entering or Editing the Characteristics of a PRT to Non-volatile Store	4-19
Recalling the Characteristics of a Known PRT	4-20
Deleting a Known PRT from the Non-volatile Store	4-20
Input	4-21
Guard	4-21
Measurement Gate Width	4-22
Maximum, Minimum and Peak-Peak	4-22
Limits	4-24
Recall Limits	4-24
Enable Limits	4-24
Standard Deviation	4-25
Syntax Diagrams of Math Functions	4-25
Averaging	4-25
Multiplication	4-27
Subtraction	4-28
Division	4-29
Decibel Calculations	4-30
Syntax Diagram of Test	4-31

Selftest	4-31
Device Errors and Syntax Diagrams	4-31
Error Detection	4-31
Recall Device Errors	4-32
Triggering and Reading Operations	4-33
Trigger Source Selector	4-33
Execute Trigger	4-34
Execute Trigger and Take a Reading	4-34
Settling Delay	4-34
Input Zero	4-36
Wait	4-36
Reading Recall	4-36
Access to the Internal Buffer Memory	4-37
Internal Operations Commands	4-39
Reset	4-39
Complete Operations	4-40
Status Reporting	4-40
Instrument I/D and Setup	4-44
Calibration Commands and Messages	4-46
Calibration Sequences	4-46
Protected User Data	4-48
Special Calibrations	4-49
5 Specifications	5-1
8508A Specifications	5-3
Maximum Voltage and Current Inputs	5-4
DC and AC Voltage	5-4
DC and AC Current	5-4
Resistance and Temperature	5-4
DC Voltage	5-5
DC Current	5-6
AC Voltage	5-7
AC Current	5-9
Resistance	5-11
Temperature	5-13
Read Rate and Additional Uncertainty	5-14
Applying the Specifications	5-15
Introduction	5-15
Absolute and Relative Specifications	5-15
Applying User's Calibration Uncertainties	5-16
Operating and Calibration Temperature Ranges	5-16
Applying Temperature Coefficient Specifications	5-16
Ratio Measurements	5-17
Additional Errors	5-17
6 Calibration and Verification	6-1
Introduction	6-3
Calibration Overview	6-3
Calibration Interval and Performance	6-3
Calibration Points	6-3
Non-Nominal Values	6-4
Enabling Access to Calibration Mode	6-4
Calibration Menus	6-4
Accessing the Calibration Menus and Calibration Mode	6-4

Calibration Menu.....	6-4
SET VALUE Menu.....	6-5
SPOT CAL Menu.....	6-6
SPOT (1 to 6) RMS Menus.....	6-6
SPOT FREQUENCY (1 to 6) Menu.....	6-6
Special Calibration.....	6-7
SPCL Menu.....	6-7
SER # = Menu.....	6-7
Hvlin Menu.....	6-8
Non-volatile input offset compensation.....	6-8
Routine Calibration.....	6-9
Equipment Required for Calibration.....	6-10
Preparing for Calibration.....	6-10
Interconnections.....	6-11
ADC Calibration.....	6-13
DC Voltage Calibration.....	6-13
AC Voltage Calibration.....	6-15
Resistance Calibration.....	6-17
DC Current Calibration.....	6-24
AC Current Calibration.....	6-26
Frequency Calibration.....	6-27
Exit From Calibration Mode and Non-Volatile Input Offset Adjustment.....	6-28
Cal Due Date Entry and Calibration Mode Disable.....	6-29
ACV Spot Frequency Calibration.....	6-29
Performance Verification.....	6-30
Equipment Requirements.....	6-31
Interconnections.....	6-31
Applicable Verification Tolerance and Conditions.....	6-31
Preparation.....	6-32
DC Voltage Checks.....	6-32
AC Voltage Checks.....	6-34
Resistance Checks.....	6-36
DC Current Checks.....	6-39
AC Current Checks.....	6-40
Frequency Checks.....	6-42

Appendices

A Error Codes and Message.....	A-1
B Rack Mount Kit.....	B-1
C Rack Mount Slide Kit.....	C-1

List of Tables

Table	Title	Page
1-1.	Standard Accessories	1-4
1-2.	Additional Accessories for the Multimeter	1-4
1-3.	Power Input Fuse 1	1-10
1-4.	Current Function Rear Input Fuse 2	1-10
3-1.	Identifying and Avoiding Errors	3-4
4-1.	IEEE Interface Capability	4-4
4-2.	Delay Defaults for DCV, DCI, ACV, and ACI.....	4-35
4-3.	Delay Defaults for Ohms, Tru Ohms, and Hi Ohms	4-35
6-1.	Required Equipment for Calibration and Performance Verification.....	6-10
6-2.	Calibration Sequence	6-11
6-3.	DC Voltage Calibration Points and Sequence.....	6-14
6-4.	AC Voltage Calibration Points and Sequence.....	6-16
6-5.	Resistance Calibration Points and Sequence.....	6-17
6-6.	DC Current Calibration Points and Sequence	6-25
6-7.	AC Current Calibration Points and Sequence	6-27
6-8.	DC Voltage Verification Points and Sequence	6-33
6-9.	AC Voltage Verification Points and Sequence	6-35
6-10.	Resistance Verification Points and Sequence	6-38
6-11.	DC Current Verification Points and Sequence.....	6-40
6-12.	AC Current Verification Points and Sequence.....	6-41

List of Figures

Figure	Title	Page
1-1.	Rear Panel - Power Input Fuse and line Power Locations	1-10
2-1.	Front Panel Displays	2-3
2-2.	Front and Rear Input Terminals	2-3
2-3.	Sample of the Main Display	2-4
2-4.	8508A Rear Panel Detail.....	2-7
2-5.	The 8508A-LEAD Measurement Lead Kit.....	2-10
3-1.	Simple Lead Connections	3-7
3-2.	Twisted-Pair Cable Connections.....	3-7
3-3.	External Guard Connections	3-7
3-4.	Internal Guard Connections	3-8
3-5.	2-Wire Measurements	3-17
3-6.	4-Wire Measurements	3-17
3-7.	4-Wire High Resistance Measurements	3-17
3-8.	Resistance Zero Measurements	3-18
3-9.	Ω Guard Measurements	3-19
3-10.	Internal Guard Connections	3-19
3-11.	PRT Connections	3-27
3-12.	Tru Ω Ratio Measurements	3-30
4-1.	IEEE 488 Input/Output Connector	4-4
4-2.	8508A Status Report Structure.....	4-8
6-1.	Equipment Connections Required for Calibration	6-12
B-1.	Installing the 8508A Rack Mount Kit.....	B-2
C-1.	Installing the 8508A Rack Mount Slide Kit.....	C-2

Chapter 1

Introduction and Safety Information

Title	Page
Introduction.....	1-3
Contacting Fluke.....	1-3
Unpacking and Inspection.....	1-3
Standard Accessories.....	1-4
Optional Accessories.....	1-4
Storing and Shipping the Multimeter.....	1-5
Line Voltage.....	1-5
Power Voltage Selector and Fuses.....	1-5
Changing Line Fuse or Supply Voltage Only.....	1-5
Calibration Enable Switch.....	1-6
System Use.....	1-6
Safety Considerations and Symbols.....	1-6
General Safety Summary.....	1-6
Symbols.....	1-8
Protection Class I.....	1-9
Protective Earth/Ground.....	1-9
Do Not Operate Without Covers.....	1-9
Safe Operating Conditions.....	1-9
Fuse Requirements.....	1-10
Rear Panel Detail.....	1-10
The Power Cable and Power Supply Disconnection.....	1-10
Terminal Connections.....	1-11
Installation/Measurement Category I.....	1-11
Maintenance and Repair.....	1-11
Moving and Cleaning.....	1-11

Introduction

The Fluke 8508A Reference Multimeter (hereafter "the Multimeter") is designed for the most demanding measurement applications and provides extremely high measurement precision in both stand-alone and systems applications.

Chapter 1 'Introduction and Safety Information' provides unpacking, storage and shipping instructions, line voltage and fuse selection, and safety information.

Chapter 2 'Getting Acquainted with the Basic' provides an introduction to the front panel keys operation and rear panel connector details.

Chapter 3 provides detailed access information to the full range of multimeter facilities, with suggestions for measurement techniques.

Chapter 4 provides detailed information for remote control access via the IEEE 488 interface.

Chapter 5 provides specification details for the multimeter.

Chapter 6 provides detailed information for access to calibration menus, suggested calibration methods and verification of the multimeter.

⚠ ⚠ Warning

To avoid electric shock, personal injury, or death, carefully read the information under *Safety Considerations* before attempting to install, use, or service the Multimeter.

Contacting Fluke

To contact Fluke for product information, operating assistance, service, or to get the location of the nearest Fluke distributor or Service Center, call:

1-888-99FLUKE (1-888-993-5853) in U.S.A.

1-800-36-FLUKE (1-800-363-5853) in Canada

+31-402-678-200 in Europe

+81-3-3434-0181 Japan

+65-738-5655 Singapore

+1-425-446-5500 from other countries

Visit Fluke's web site at: www.fluke.com.

Unpacking and Inspection

Every care is taken in the choice of packing material to ensure that your equipment will reach you in perfect condition.

If the equipment has been subject to excessive handling in transit, the fact will probably be visible as external damage to the shipping carton.

In the event of damage, the shipping container and cushioning material should be kept for the carrier's inspection.

Carefully unpack the equipment and check for external damage to the case, sockets etc. If the shipping container and packing material are undamaged, they should be retained for use in subsequent shipments. If damage is found notify the carrier and your sales representative immediately.

For orders of the model 8508A/01 check that the instrument has the six terminals on the rear panel for connection of signals.

Standard Accessories

The standard accessories supplied with the instrument are shown in Table 1-1. The type of power cable supplied is determined at the time of ordering.

Table 1-2 lists additional accessories available for use with the Multimeter.

Table 1-1. Standard Accessories

Description	Location	Order Number
Power Cable	USA	LC1 284174
	UK	LC4 769455
	Europe	LC3 769422
	Swiss	LC5 769448
	India	LC7 782771
	China / Fiji / New Zealand	LC6 658641
General Purpose CAT 11 Probe Kit and Wallet comprising: 2x Test Leads with 4mm Safety shroud plugs (Red and Black) 2x Test Probe and mating crocodile clip (Red and Black) 2x 4mm shrouded plug adapters (and hex key lock-in tool) 2x 4w Zero PCB		
Users Manual		1673798

Optional Accessories

Table 1-2. Additional Accessories for the Multimeter

Description	Order Number
Rack Mount Kit	Y8508 1886215
Rack Mount Slide Kit	Y8508S 1886232
Platinum Resistance Probe, Case and certificate. R0 100 Ohms Hart 5626-15-S	8508A – PRT 1886194
Standard Platinum Resistance Probe, Case and certificate. R0 25.5 Ohms. Calibration by comparison Hart 5699 1920-4-7	8508A – SPRT 1886182
Accredited UKAS calibration	1883673
Accredited NVLAP calibration	1256990
Calibration Kit comprising 1G Ohm standard, 2x 4 wire Zero PCB and connecting lead for 5720A/5725	8508A-7000K 1886226
PTFE Lead Kit and Wallet comprising: 4x Shielded leads with gold spades 1x High-current lead with gold spades 10x 4mm shrouded plug adapters 1x General Purpose DMM Probe Kit (as above)	8508A – LEAD 1886203

Please note that accessories (except for Accredited Calibration) are generally shipped separately, please refer to the Packing List supplied with your 8508A.

Storing and Shipping the Multimeter

The Multimeter should be stored under cover. The shipping container provides the most suitable receptacle for storage, as it provides the necessary shock isolation for normal handling operations.

Place the Multimeter inside a sealed bag. Place the bag into the cushioning material inside the shipping container, and put the whole package in a location that complies with the storage environment specification described in Chapter 5.

If the Multimeter is shipped, use the original shipping containing if possible. It provides shock isolation for normal handling operations. Any other container should provide similar shock isolation to the following approximate internal packing dimensions (the front terminals should be free):

Container	Length	Width	Depth
Box	630 mm (25 in)	550 mm (22 in)	230 mm (9 in)
Cushioned	480 mm (19 in)	440 mm (17.3 in)	100 mm (4 in)

Place the instrument inside a sealed bag. Fit the bag into the cushioning material inside the shipping container, and secure the whole package.

Line Voltage

Power Voltage Selector and Fuses

The instrument is packed ready for use with a line voltage determined at the time of ordering. The fuse that corresponds to the set line voltage is installed in the Multimeter.

8508A 115 or 8508A/01 115	For 100V to 120V supplies
8508A 230 or 8508A/01 230	For 200V to 240V supplies

Changing Line Fuse or Supply Voltage Only

The integrated POWER SWITCH, POWER INPUT plug contain the fuse drawer which gives access to the line fuse and the line voltage selector.

Insert a small screwdriver blade in the narrow recess above the catch over the fuse drawer to gain access to the fuse and the voltage selector.

To change from one voltage to the other, remove the voltage selector block and rotate until the desired voltage faces outward. Refit the selector block and fit the corresponding fuse. Check that the desired voltage is visible in the cutout of the fuse drawer.

For 200 V to 240 V supplies 230 is shown in the voltage selector window on the rear panel, and the fuse is rated at 630 mA.

For 100 V to 120 V supplies 115 is shown in the window and the fuse rating is 1.25 A.

Refer to Table 1-3 for full details of replacement Power Input fuse types.

Calibration Enable Switch

This two-position switch on the rear panel protects the instrument calibration memory.

The instrument was initially calibrated at the factory and the switch covered with a calibration sticker, so the sticker and the switch should remain as delivered, until immediate recalibration is intended.

If the calibration menu is selected while the calibration switch is not in the enabled position, the menu is replaced by the warning message:

CALIBRATION DISABLED

System Use

The Multimeter is designed as standard to form part of a system, conforming to IEEE 488.2 Standard Digital Interface. The Device Documentation Requirements of this standard are provided in Chapter 4.

Safety Considerations and Symbols

This sections addresses safety considerations and describes symbols that appear on the Multimeter.

A **⚠ Warning** statement identifies conditions or practices that could result in injury or death.

A **⚠ Caution** statement identifies conditions or practices that could result in damage to the Multimeter or equipment to which it is connected.

⚠⚠ Warning

This instrument can deliver a lethal electric shock.

To avoid electric shock, personal injury, or death, carefully read the information under *Safety Considerations* before attempting to install, use, or service the Multimeter.

General Safety Summary

This instrument has been designed and tested in accordance with the European standard publication EN61010-1 : 2001 and U.S. / Canadian standard publications UL 61010-1A1 and CAN/CSA-C22.2 No.61010.1. The instrument has been supplied in a safe condition.

This manual contains information and warnings that must be observed to keep the instrument in a safe condition and ensure safe operation.

Using or servicing this Multimeter in conditions other than as specified in the Users Manual could compromise your safety.

To use the use the Multimeter correctly and safely, read and adhere to the precautions on the "Safety Page" and follow all the safety instructions or warnings given throughout this manual that relate to specific measurement functions. In addition, follow all generally accepted safety practices and procedures required when working with and around electricity.



















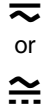







⚠ ⚠ Safety Page

Warning: To avoid possible electric shock, personal injury, or death, read the following before using the Multimeter:

- ⇒ Use the Multimeter only as specified in this manual, or the protection provided by the Multimeter might be impaired.
- ⇒ Do not use the Multimeter in wet environments.
- ⇒ The Multimeter can output lethal voltages. Use it only as described in this manual.
- ⇒ Inspect the Multimeter before using it. Do not use the Multimeter if it appears damaged. Pay particular attention to the insulation around the connectors.
- ⇒ Inspect the test leads before use. Do not use them if insulation is damaged or metal is exposed. Check the test leads for continuity. Replace damaged test leads before using the Multimeter.
- ⇒ Verify the Multimeter's operation by measuring a known voltage before and after using it. Do not use the Multimeter if it operates abnormally. Protection may be impaired. If in doubt, have the Multimeter serviced.
- ⇒ Whenever it is likely that safety protection has been impaired, make the Multimeter inoperative and secure it against any unintended operation.
- ⇒ Have the Multimeter serviced only by qualified service personnel.
- ⇒ Do not apply more than the rated voltage, as marked on the Multimeter, between the terminals or between any terminal and earth ground.
- ⇒ Always use the power cord and connector appropriate for the voltage and outlet of the country or location in which you are working.
- ⇒ Remove test leads from the Multimeter before opening the case.
- ⇒ Never remove the cover or open the case of an instrument without first removing the power source.
- ⇒ Never operate the Multimeter with the cover removed or the case open.
- ⇒ Use caution when working with voltages above 30 V ac rms, 42 V ac peak, or 42 V dc. These voltages pose a shock hazard.
- ⇒ Use only the replacement fuse(s) specified by the manual.
- ⇒ Use the proper terminals, function, and range for your measurements.
- ⇒ Do not operate the Multimeter around explosive gas, vapor, or dust.
- ⇒ When using probes, keep your fingers behind the finger guards.
- ⇒ When making electrical connections, connect the common test lead before connecting the live test lead; when disconnecting, disconnect the live test lead before disconnecting the common test lead.
- ⇒ Disconnect circuit power and discharge all high-voltage capacitors before testing resistance, continuity, diodes, or capacitance.
- ⇒ Before measuring current, check the Multimeter's fuses and turn OFF power to the circuit before connecting the Multimeter to the circuit.
- ⇒ When servicing the Multimeter, use only specified replacement parts.

Symbols

The following safety and electrical symbols may be used on the Multimeter or in this manual.

	Risk of danger. Important information. See manual.		Power ON / OFF
	Hazardous voltage. Voltage > 30 V dc or ac peak might be present		Earth ground.
	AC (Alternating Current).		Capacitance.
	DC (Direct Current).		Diode.
	AC or DC (Alternating or Direct Current)		Laser caution.
			Warning. Laser.
	Continuity test or continuity beeper tone.		Fuse.
	Digital signal.		Warning. Hot or burn hazard.
	Potentially hazardous voltage.	CAT	IEC 61010 Overvoltage (installation or measurement) Category .
	Brightness / contrast adjustment		Display backlight
	Double insulated.		Recycle.
	Static awareness. Static discharge can damage part(s).		Do not mix with solid waste stream. Dispose using a qualified recycler or hazardous material handler.
	Do not connect to public network (e.g., telephone system.)		Maintenance or Service.
	Battery or battery compartment. Low battery when shown on display.		Tone or beep.

Protection Class I

Protective Earth/Ground

The Multimeter **must** be operated with a Protective Earth/Ground connected via the power cable's protective earth/ground conductor. The Protective Earth/Ground connects to the instrument before the line & neutral connections when the supply plug is inserted into the power socket on the back of the instrument.

Warning

To avoid possible electric shock, personal injury, or death:

- Ensure that no interruption of the protective ground conductor inside or outside the instrument has occurred. Any interruption of the protective ground is likely to make the instrument dangerous.
- Make signal connections to the instrument after making the protective ground connection.
- Remove signal connections before removing the protective ground connection, i.e. the power cable must be connected whenever signal leads are connected.

Do Not Operate Without Covers

Warning

To avoid possible electric shock, personal injury, or death, do not operate the instrument with its covers removed.

The covers protect users from live parts, and unless otherwise stated, must only be removed by qualified service personnel for maintenance and repair purposes.

Removing the covers may expose voltages in excess of 1.5 kV peak.

Safe Operating Conditions

Warning

To avoid electric shock or fire hazard, do not apply to or subject the Multimeter to any condition that is outside specified range. See Chapter 5 of this manual for detailed instrument specifications and operating conditions.

Only operate the Multimeter within the manufacturer's specified operating conditions. Examples of operating condition specifications examples that must be considered include:

- Ambient temperature
- Ambient humidity
- Power supply voltage & frequency
- Maximum terminal voltages or currents
- Altitude
- Ambient pollution level
- Exposure to shock and vibration

Caution

To avoid possible damage to the Multimeter, consider direct sunlight, radiators and other heat sources when assessing ambient temperature.

Before connecting the Multimeter to the supply, make sure that ac supply voltage connector on the rear panel is set to the correct voltage and that the correct fuses are fitted.

Fuse Requirements

⚠ Caution

To avoid fire hazard, use only the fuse arrangements that appear in the fuse specification Tables 1-2 and 1-3 below.

Additionally, the supply network must be fused at a maximum of 16 A, and if the power cable plug is internally fused, a 5 A fuse must be fitted in the power cable plug.

Table 1-3. Power Input Fuse 1

Power Input Fuse F1	Fuse Action	Fuse Rating IEC 127 (UL/CSA)	Fluke Part No.	Manufacturer & Type No.
115 VAC	TH Time delay HBC	1.25 A (2 A) @ 250V	920204	Schurter 001.2505
230 VAC	TH Time delay HBC	630 mA (1 A) @ 250V	920203	Schurter 001.2502

Table 1-4. Current Function Rear Input Fuse 2

Fuse Action	Fuse Rating IEC 127 (UL / CSA)	Fluke Part No.	Manufacturer & Type No.
FH Fast acting HBC	1.6 A (2 A)	920071	Beswick S501

Rear Panel Detail

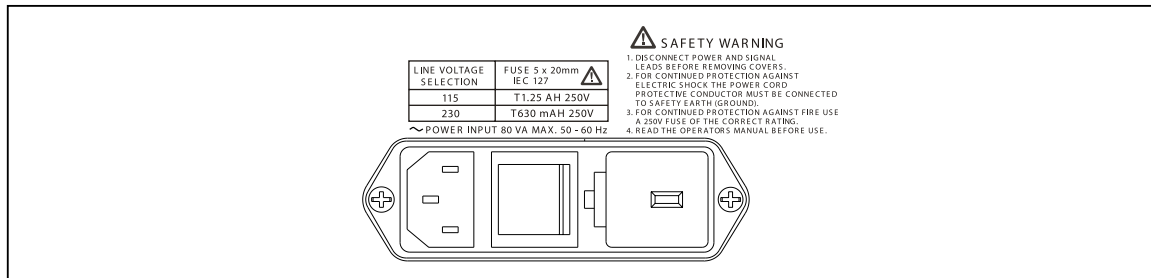

Figure 1-1. Rear Panel – Power Input Fuse and line Power Locations

The Power Cable and Power Supply Disconnection

The intended power supply disconnect device is the ON/OFF switch that is located on the Multimeter's rear panel.

The ON/OFF switch **must** be readily accessible while the instrument is operating. If this operating condition cannot be met, the power cable plug or other power disconnecting device **must** be readily accessible to the operator.

⚠ ⚠ Warning

To avoid electric shock and fire hazard, make sure that the power cable is not damaged, and that it is adequately rated against power supply network fusing.

If the power cable plug is to be the accessible disconnect device, the power cable must not be longer than 3 meters.

Terminal Connections

Make sure that the instrument is correctly grounded (earth ground) via the power cable before and while any other connection is made.

Installation/Measurement Category I

Measurement and/or guard terminals are designed for connection at Installation or Measurement Category I.

⚠️⚠️ Warning

To avoid electric shock and fire hazard, do not connect the Multimeter terminals directly to the ac line power, to an ac line power current transformer, or to any other voltage or current source that may (even temporarily) exceed the instrument's peak ratings.

⚠️⚠️ Warning

To avoid injury or death, do not connect or disconnect signal leads while they are connected to a hazardous voltage or current source.

Make sure that signal leads are in a safe condition before you handle them.

This instrument can deliver a lethal electric shock. Never touch any lead or terminal unless you are absolutely certain that no dangerous voltage is present.

Maintenance and Repair

⚠️ Warning

For protection against injury and fire hazard, use only manufacturer supplied parts that are relevant to safety. Perform Safety tests after replacing any part that is relevant to safety.

Observe all applicable local and/or national safety regulations and rules while performing any work.

First disconnect the instrument from all signal sources, then from the ac line supply before removing any cover.

Any adjustment, parts replacement, maintenance or repair should be carried out only by the manufacturer's authorized service personnel.

Moving and Cleaning

First disconnect the Multimeter from all signal sources, then from the AC line power before moving or cleaning.

Use only a damp, lint-free cloth to clean fascia and case parts.

Chapter 2

Getting Acquainted with the Basics

Title	Page
Introduction.....	2-3
Input Terminals.....	2-3
The Front Panel Displays.....	2-4
Front Panel Keys.....	2-4
Soft-Keys and Manual Conventions.....	2-4
Numeric Keyboard	2-5
Exiting a Menu	2-5
Major Function Keys.....	2-5
Direct Action Keys	2-6
Mode Keys.....	2-6
Rear Panel.....	2-7
Labels	2-7
Fuses.....	2-7
Voltage Selector	2-7
Power Input and Power Switch	2-7
Calibration Switch.....	2-7
Rear Panel Connectors and Pin Designations.....	2-8
Rear Inputs.....	2-8
External Trigger Input	2-8
IEEE 488 Input/Output.....	2-8
Power-On Configuration.....	2-8
The 8508A-LEAD Measurement Lead Kit.....	2-9

Introduction

Chapter 2 introduces the front and rear panel features of the 8508A Reference Multimeter (hereafter, referred to as the Multimeter). Figure 2-1 shows the Multimeter's front panel controls, indicators, and connectors.

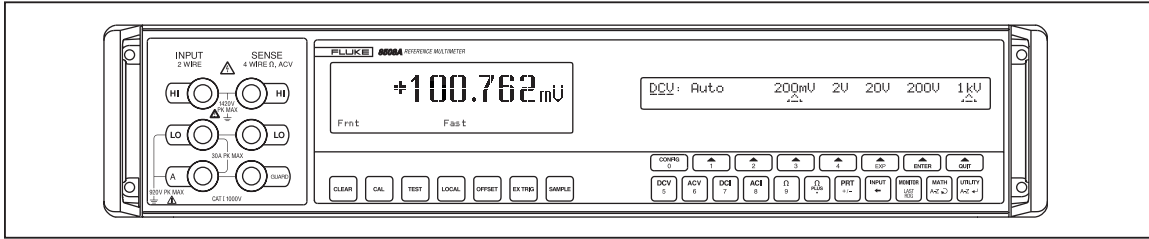

Figure 2-1. Front Panel Displays

adj002f.eps

Input Terminals

⚠ ⚠ Warning

to avoid electric shock, personal injury, or death, never touch any lead or terminal on the Multimeter unless you are absolutely certain that no dangerous voltage is present.

The 8508A Multimeter has only front terminals. The 8508A/01 has both front and rear panel input terminals (Figures 2-2). Select either, or Scan both from the Input menu or via IEEE-488 remote control.

For maximum input limits, refer to product specifications in Chapter 5.

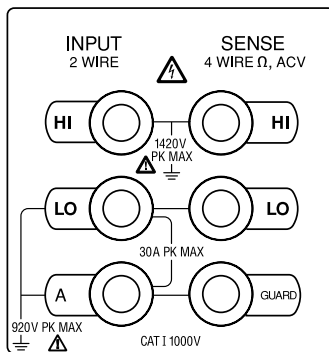

adj013f.eps

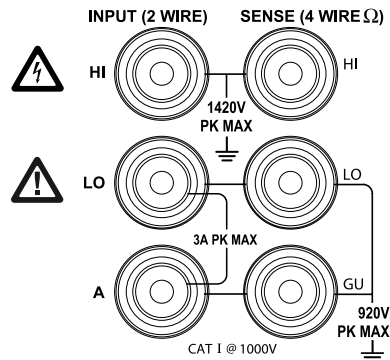

adj014f.eps

Figure 2-2. Front and Rear Input Terminals

Three pairs of 4 mm ‘banana’ terminals are fitted on the left of the front panel and, as an option, on the right of the rear panel. Their functions are as follows:

INPUT 2 wire		SENSE 4WIRE Ω, ACV	
HI	Voltage High Ohms High (2 – wire)	HI	Voltage High (4-wire <i>front only</i>) Ohms High (4-wire)
LO	Voltage Low Current Low Ohms Low (2-wire)	LO	Voltage Low (4-wire <i>front only</i>) Ohms Low (4wire)
A	Current High (<i>only 2A max on rear</i>)	GUARD	

The Front Panel Displays

The front panel (Figure 2-1) has two displays:

- The display on the left, the main display, is used to show all measurement readings, with status legends on the bottom line, and measurement qualifiers on the line above. Figure 2-3 shows details of the main display, including annunciators.
- The display on the right is used to display menus for the softkeys situated below. It is also used for error messages and status information when in remote.



adj360f.eps

Figure 2-3. Sample of the Main Display

Front Panel Keys

There are four types of keys (Figure 2-1) on the front panel:

- The major measurement function keys:
- The mode keys:
- Direct action keys that immediately initiate an action or set a state:
- The "soft-keys" point to a menu label on the display above, indicating the operation and setting of the Multimeter:

System messages may appear to clarify settings or operations.

Soft-Keys and Manual Conventions

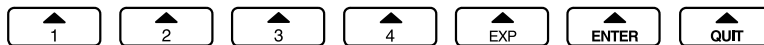

adj015f.eps

Soft-Keys

- A Menu softkey accesses a new menu.

In this manual, a Menu soft-key is shown as displayed or in a Helvetica-regular font:

Example: Res1 or Res1

- A Toggle softkey enables or disables a selection

The enabled selection is indicated with a • symbol.

In this manual, a Toggle soft-key is shown as displayed or in Helvetica-italic-underline font :

Example: Filt or *Filt*

- A Choice softkey chooses a state (e.g., selects a range) or triggers a direct action.

The selected state or action is indicated as displayed with a • symbol.

In this manual, a Choice soft-key is shown as displayed or in Helvetica-underline font:

Example: 100mV or 100mV

Numeric Keyboard

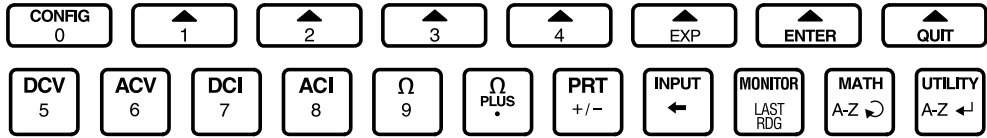

adj012f.eps

Numeric Keyboard

The operation of the numeric keys is enabled for appropriate menus. The active keys are:

numerals 0 to 9.

decimal point

polarity

for exponent

for backspace

to enter the last reading taken

to confirm the numeric entry

to abort the numeric entry.

When the numeric keyboard is active other keys are locked out.

For some operations the two alpha selection keys are enabled along with the numeric keys.

selects the alpha characters (upper case only) and cycles A through Z.

enters the selected character and moves the entry point one character to the right.

Exiting a Menu

You can generally exit from any menu by pressing a measurement function key or a mode key.

For those menus where the numeric or alpha numeric keyboard is active, exit by pressing either Enter or Quit. For some menus, a special soft key permits exit by a single keystroke.

Major Function Keys

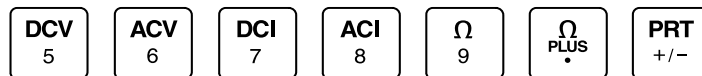

adj016f.eps

Each measurement function has a CONFIG (Configuration) menu, from which you can select function-dependent parameters such as resolution and filter settings.

Once set, the instrument remembers the function dependant parameters until you change it or turn the Multimeter off.

Direct Action Keys



adj017f.eps

Direct Action Keys

 Press to disable internal triggers and enable all external trigger sources. The Ext annunciator on the main display is lit.

An external trigger for a measurement may be generated either by pressing the Sample key, by sending an appropriate trigger command via the IEEE-488 interface, or by a falling edge (TTL) at the External Trigger input on the rear panel.

 Press to trigger a single-shot measurement if the Multimeter is in Ext'trig mode. All measurements triggered using the Sample key are subject to the standard internal time delays before A-D conversion. These are listed on Table 4-2 and 4-3. During the measurement the Busy annunciator on the main display is lit.

NOTE

In calibration mode this key will initiate a calibration operation.

 Press to return the Multimeter to the control of the front panel when operating on the IEEE-488 bus. While in Local, any delays set up during remote programming are suspended, and the standard internal delays are reinstated. The Local mode can be disabled remotely by a controller using the LLO (Local Lockout) function.

 Press to store the displayed value in memory. This temporary value will be subsequently subtracted from the next measured value. The Offset annunciator on the main display is lit. To cancel this subtraction press the Offset key.

Mode Keys

 Press to enter calibration mode. Access to calibration mode is enabled (or restricted) by a calibration switch on the rear panel. The CAL annunciator on the left hand display indicates that Calibration mode is active.

 Press to gain access to test operations.

 Press to gain access to guarding, input zero operation, selection of alternate inputs, and scanning operations. Several left hand display annunciators are used to indicate the status of input, guard and zero selection.

 Provides additional monitoring operations on measurements e.g. frequency (in AC), and recorded measurements of maximum, minimum, and peak to peak.

 Provides additional mathematical operations on measurements e.g. averaging, multiplication by M, subtraction of C, and division by Z. The Math annunciator on the left hand display indicates that a Mathematical operation is active.

 Press to gain access to bus address, display adjustments, line frequency selection, and information on cal due date, serial number and spot frequency.

 Press to gain access to removing Input zero for the range selected or all the ranges in the selected function.

The instrument can also be reset to the power up state.

Rear Panel

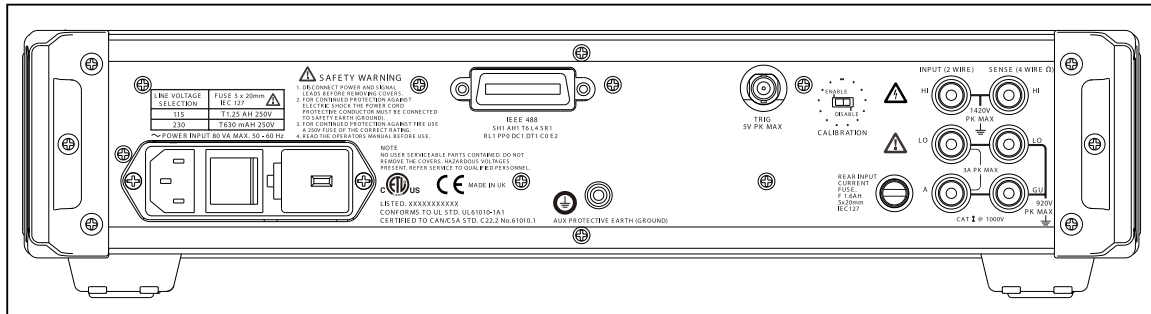

Figure 2-4. 8508A Rear Panel Detail

Labels

Attached to the rear panel are the identification label for the instrument, and a modification strike label.

Fuses

⚠ Power Fuse: Located in the fuse drawer which is part of the integrated module for power input and voltage selection.

⚠ Rear Input Current Fuse: Protects the current measuring circuitry when using the rear terminals for signal input.

⚠ ⚠ Warning

To avoid damage to the Multimeter, or shock, injury, or death, use **ONLY** fuses with the amperage, interrupt, voltage, and speed ratings specified.

Refer to the safety information and "Fuse Requirements" in Chapter 1 of this manual.

Voltage Selector

The power line voltage selector block is located behind the fuse block drawer, and adapts the instrument to either 115V or 230V line inputs.

Power Input and Power Switch

The power input socket and power ON/OFF switch are part of the integrated module for power input and voltage selection. Power on default configuration is listed later in this chapter.

Calibration Switch

Access to calibration mode is enabled (or restricted) by the rear panel calibration switch. Setting the switch to ENABLE will allow access to the calibration mode via the front panel CAL key and the CALIBRATION menu, and will also enable the remote IEEE-488 interface calibration commands.

The calibration switch should always be set to DISABLE on completion of any calibration operations. Applying an integrity seal or calibration sticker to cover the rear panel Calibration switch is a convenient way to ensure the security of calibration prevent unauthorized access to the switch.

Rear Panel Connectors and Pin Designations

⚠⚠ Warning

This instrument can deliver a lethal electric shock.

to avoid electric shock, personal injury, or death, never touch any lead or terminal unless you are absolutely certain that no dangerous voltage is present.

Rear Inputs

For details of rear input terminals see Figure 2-1

External Trigger Input

This co-axial BNC socket can be used to trigger a measurement when external triggers are enabled.

The single pin is pulled up internally to +5V, and requires a negative-going TTL edge to initiate the reading.

IEEE 488 Input/Output

The IEEE 488 input/output is a 24-way Amphenol connector which is directly compatible with the IEEE 488 interface and the IEC 625 Bus.

Note that the Bus Address is set from the front panel. See Chapter 4 for more information about the IEEE 488 connector and remote operations.

Power-On Configuration

To turn the Multimeter on, use the Power Switch on the rear panel. The Multimeter powers on in the following configuration:

Function	DCV
Range	1 kV
Resolution	7-1/2 digits
Input	Front
Filter	Off
Fast	On
External Guard	Off
Scan	Off
Monitor	Off
Math	Off

The 8508A-LEAD Measurement Lead Kit

⚠️⚠️ WARNING – SAFE USE OF MEASUREMENT LEADS

To avoid electric shock and potential injury or death, DO NOT use low voltage spade-terminated leads to connect to hazardous voltage (>32V ac rms or > 42V pk). CAT II probes and test leads and adapters are provided for Safe measurement at higher voltages.

To avoid electric shock and potential injury or death, ensure that the 4mm terminal post adapters are always securely tightened before use.

A CAT II DMM Probe, lead and adaptors kit is provided with the Multimeter. Instructions for use are included in the 8508A-LEAD kit description below.

The optional 8508A-LEAD Kit is a comprehensive set of high integrity measurement leads, designed for metrology applications. The kit and its contents are described below and shown in figure 2-4. The kit includes the following:

1. Five low-thermal-EMF low-leakage leads sets for low voltage precision measurement applications. All five lead sets feature gold-plated 6mm spade terminations.
 - Four of the leads are low-thermal, PTFE insulated and shielded for signal applications.
 - One lead is a heavy gauge lead for high current (>2A rms) applications.
2. One CAT II DMM Probe and lead set (not shown) for general purpose and High Voltage measurement applications. Terminal Post adapters plug into the 8508A terminals and are then locked into place by gently but securely tightening them with the hex key tool as shown. The 4mm Safety shrouded test lead plugs may then be inserted into the adapters.
3. Two high-integrity 4-wire-zero PCBs. These PCBs are used to Input Zero the Multimeter terminals during the Calibration and Verification procedures.

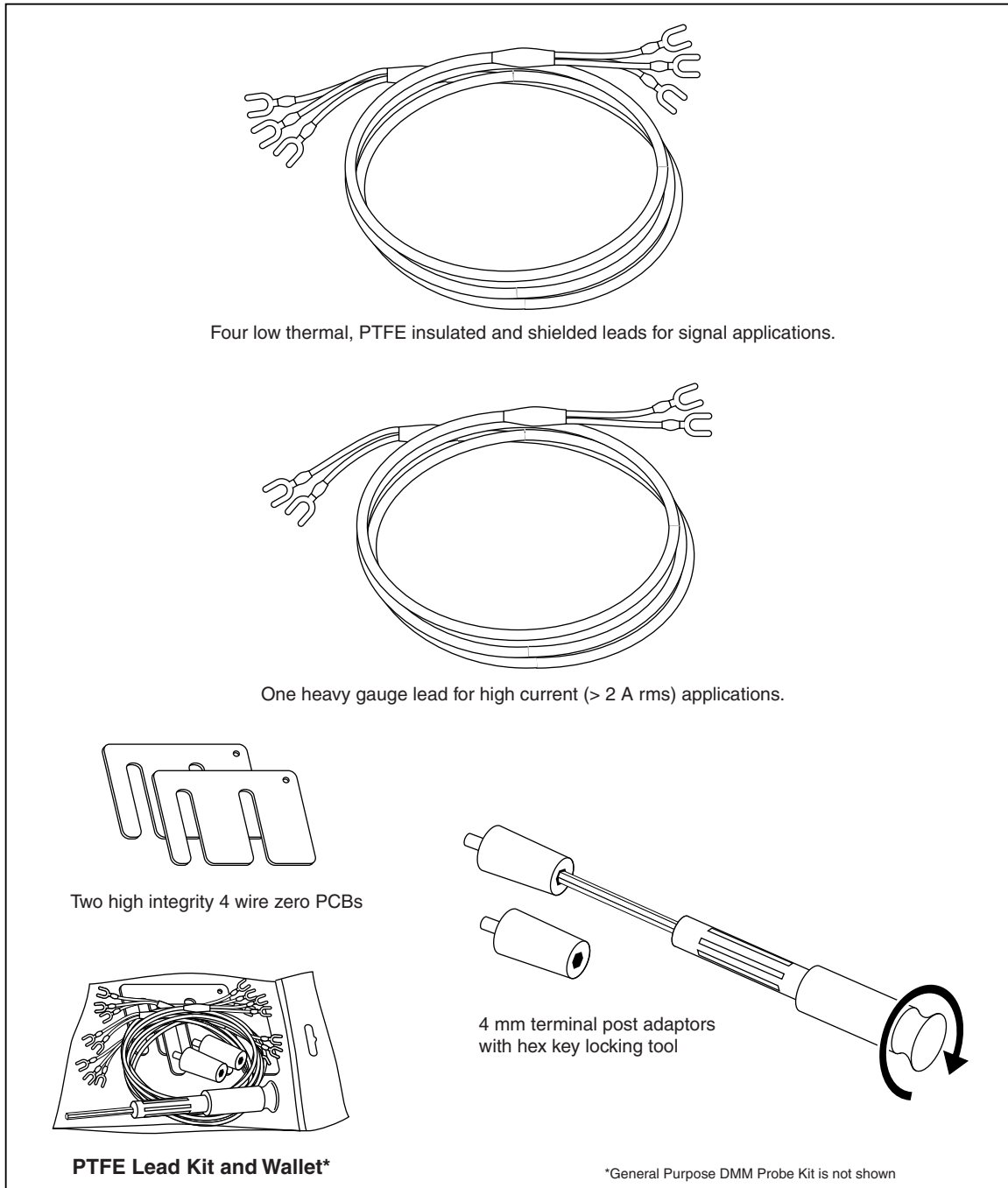

Figure 2-5. The 8508A-LEAD Measurement Lead Kit

Chapter 3

Making Measurements

Title	Page
Introduction.....	3-3
Making Connections to the Multimeter -- General Guidelines.....	3-4
Using the Measurement Functions.....	3-5
DC Voltage.....	3-5
Measuring DC Voltage.....	3-7
Making Input Connections.....	3-7
AC Voltage.....	3-8
Measuring AC Voltage.....	3-11
Induced Interference.....	3-11
Common Mode Rejection.....	3-11
Lead Considerations.....	3-11
Resistance.....	3-11
High Voltage Ohms.....	3-13
True Ohms.....	3-15
Measuring Resistance.....	3-16
2-Wire Measurements.....	3-16
4-wire Measurements.....	3-17
4-wire High Resistance Measurements.....	3-17
4-wire Resistance Zero.....	3-18
Ω Guard.....	3-18
DC Current.....	3-20
Measuring DC Current.....	3-21
AC Current.....	3-22
Measuring AC Current.....	3-23
Temperature.....	3-24
Measuring Temperature.....	3-27
Multimeter Inputs.....	3-28
Input.....	3-28
Using the INPUT Key.....	3-28
SCAN OPERATIONS.....	3-29
Tru Ohms Ratio.....	3-30
Monitoring Modes.....	3-31
Monitor Key.....	3-31
Displaying Signal Frequency.....	3-31
Displaying Standard Deviation.....	3-31
Devn Menu.....	3-31

Displaying Maximum, Minimum, and Peak-to-Peak Readings	3-32
MAX Menu	3-32
Limit-Checking	3-32
Monitor Menu Tree	3-33
Utility	3-33
Using the Selftest Functions	3-36
Test Menu Tree.....	3-36
Test Key	3-37
Using the Math Functions.....	3-38
Math Functions and Menu Tree.....	3-38
Math Configuration	3-39
Clear Functions	3-40

Introduction

⚠ ⚠ Warning

This instrument can deliver a lethal electric shock.

To avoid electric shock, personal injury, or death, carefully read the information under "Safety Considerations" in Chapter 1 before attempting to install, use, or service the 8508A Reference Multimeter.

A "⚠ ⚠ Warning" statement identifies conditions or practices that could result in injury or death.

A "⚠ ⚠ Caution" statement identifies conditions or practices that could result in damage to the Multimeter or equipment to which it is connected.

Chapter 3 explains in detail how to use the 8508A Reference Multimeter's (hereafter "the Multimeter") measurement functions and operating modes. It is organized to provide easy access to the following functions and modes.

Functions

DC Voltage AC Voltage Resistance DC Current AC Current Temperature

Modes

Input Control Monitoring Math Utility Clear Test

The topics covered in Chapter 3 include: making connections, input limits, types of configurations, accessing and selecting measurement modes, and calculations available.

Product specifications and operating limits are in Chapter 5. See Chapter 6 for calibration menus and the recommended calibration routines. All error messages displayed by the Multimeter's front panel or generated by the IEEE 488 system bus are collected and described in Appendix A.

Before proceeding make sure that the Multimeter has been properly installed and prepared for operation as described in Chapter 1.

⚠ ⚠ Warning

Using this instrument can deliver a lethal electric shock. To avoid possible electric shock, personal injury, or death:

- **Ensure that no interruption of the protective ground conductor inside or outside the instrument has occurred. Any interruption of the protective ground is likely to make the instrument dangerous.**
- **Never touch any lead or terminal unless you are absolutely certain that no dangerous voltage is present.**

Making Connections to the Multimeter -- General Guidelines

The 8508A Reference Multimeter is capable of providing highly accurate traceable measurements. To attain this accuracy, it is necessary to make connections to any external circuitry or load correctly. A few guidelines are given in Table 3-1.

Table 3-1. Identifying and Avoiding Errors

Sources of Inaccuracy	Avoiding or Minimizing Inaccuracy
<p>Thermal EMFs</p> <p>These can give rise to series (Normal) mode interference, particularly where large currents have a heating effect at junctions.</p> <p>In otherwise thermoelectrically-balanced measuring circuits, cooling caused by drafts can upset the balance.</p>	<ul style="list-style-type: none"> • Screen thermal junctions from draughts. • Allow time for thermal equilibrium to be reached before taking readings. • Use conductors, joints and terminals with a good margin of current-carrying capacity. • Avoid thermoelectric junctions where possible: <ul style="list-style-type: none"> * Use untinned single-strand copper wire of high purity. * Avoid making connections through Nickel, Tin, Brass and Aluminum. If oxidation is a problem, use gold-plated copper terminals, and replace the terminals before the plating wears off. * If joints must be soldered, low-thermal solders are available, but crimped joints are preferred. * Use low-thermal switches and relays where they form part of the measuring circuit. * Balance one thermal EMF against another in opposition, where possible. (Switch and relay contacts, terminals etc.)
<p>E-M Interference</p> <p>Noisy or intense electric, magnetic and electromagnetic effects in the vicinity can disturb the measurement circuit. Some typical sources are:</p> <ul style="list-style-type: none"> • Static electric fields. • Fluorescent lighting. • Inadequate shielding, filtering or grounding of power lines. • Transients from local switching. • Induction and radiation fields of local E-M transmitters. • Excessive common mode voltages between source and load. <p>The disturbances can be magnified by the capacitance of the user's hand. Electrical interference has greatest effect in high impedance circuits. Separation of leads and creation of loops in the circuit can intensify the disturbances.</p>	<ul style="list-style-type: none"> • Choose as "quiet" a site as possible (a screened cage may be necessary if interference is heavy or circuit impedance is high). Suppress as many sources as possible. • Always keep interconnecting leads as short as possible, especially unshielded lengths. • Run leads together as twisted pairs in a common shield to reduce loop pick-up area, but beware of leakage problems and excessive capacitance. • Where both source and load are floating, connect Lo to ground at the source to reduce common mode voltages. • If an external measurement ground connection has been made, select External Guarding at the Multimeter in Voltage and Current functions and deselect External Guarding in Ohms and PRT functions. • When connecting to a Multifunction Calibrator such as the Fluke 5720A or 5520A, follow the above Guarding and Grounding advice and deselect External Guard at the Calibrator.
<p>Lead Resistance</p> <p>The resistance of the test leads can drop significant voltages between the source and load, especially at high load currents.</p>	<ul style="list-style-type: none"> • Keep all leads as short as possible. • Use conductors with a good margin of current-carrying capacity. • Use External Guard or 4-wire connections where necessary.
<p>Lead Insulation Leakage</p> <p>This can cause significant errors in measurement circuits at high voltages and high resistances. Some insulating materials suffer greater losses than others, e.g. PVC has more leakage than PTFE.</p>	<p>Choose low loss insulated leads - PTFE is preferred to PVC. When running leads together in shielded pairs, avoid large voltages between leads in the same screen, especially if using PVC insulation.</p>

Using the Measurement Functions

If you are unfamiliar with the front panel controls, review the relevant sections of Chapter 2.

DC Voltage

Press **DCV** key to display the DCV menu.

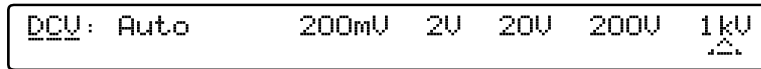

DCV: Auto 200mV 2V 20V 200V 1kV

adj055f.eps

DCV Menu

- DCV** This function provides both 2-wire and 4-wire measurements, in decade ranges from 200mV to 200V and a 1kV range.
- Auto** To cancel autoranging and enter a manually selected range, press any range selection or the Auto softkey. The Multimeter enters the selected range or reverts to the auto-selected range.

DCV Configuration (4 wire Sense, Resolution, LP Filtering and Fast)

Press the Config key to see the DCV CONFIG menu:

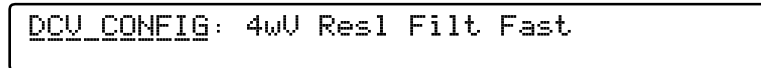

DCV_CONFIG: 4wV Res1 Filt Fast

adj056f.eps

DCV Configuration Menu

- 4wV** Allows operation with calibrators which provide a remote 4 wire sensing capability by providing connections between **INPUT HI** and **SENSE HI** and between **INPUT LO** and **SENSE LO**.
The 4wV annunciator in the left-hand display indicates that 4-wire sensing is active.
- Res1** Provides selection of the numerical resolution for subsequent readings.
- Filt** Controls a two-pole analog filter for increased noise rejection.
The Filter annunciator on the left-hand display indicates that the filter is active and indicates its cut-in frequency.
- Fast** Select a higher read rate. This will result in an increase in uncertainty due to noise.
The Fast annunciator on the left-hand display indicates that the higher read rate is active.

DCV Resolution

Press the Resl key to see the DCV RESL menu:



DCV Resolution Menu

adj058f.eps

- 5 5-1/2-digits resolution
- 6 6-1/2-digits resolution
- 7 7-1/2-digits resolution
- 8 8-1/2-digits resolution

To revert to the DCV CONFIG menu, press the CONFIG key.

To revert to the DCV menu from either DCV RESL or DCV CONFIG, press the DCV key.

Refer to table 3-1 for the ADC integration times applicable to the various resolution and Fast On/Off settings.

Table 3-1. Analog to Digital Converter (ADC) signal integration times

Function	Resolution	Integration Time	
		Fast On	Fast Off
DCV, DCI ¹ , Ohms, True Ohms, PRT ²	5-1/2	3.3ms	1 PLC
	6-1/2	1 PLC	16 PLC
	7-1/2	64 PLC	4 x 64 PLC
	8-1/2	4 x 64 PLC	16 x 64 PLC
HiV Ohms	5-1/2	64 PLC	
	6-1/2	64 PLC	

Note: PLC = Power Line Cycles = 20ms at 50Hz line, 16.67ms at 60Hz line.
 1. DCI maximum resolution 7-1/2 digits.
 2. Fast On not available in PRT.

DC Voltage - Movement between Menus

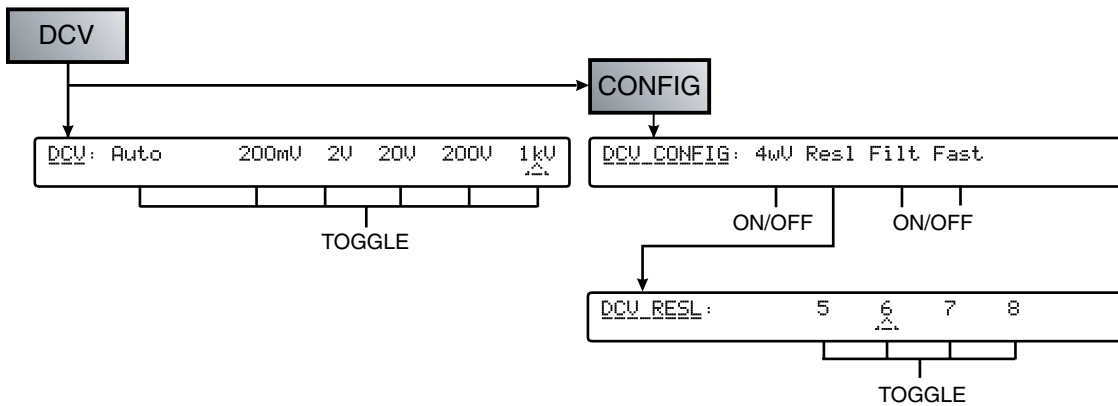

DC Voltage Menu Tree

adj054f.eps

Measuring DC Voltage

Making Input Connections

Simple Lead Connection

For the majority of applications the simple lead connection without external guard will be adequate. See Figure 3-1. The disadvantage of this simple arrangement is that the connecting leads can form a loop. If a stray alternating magnetic field (e.g., from the line transformer of a neighboring instrument) passes through the loop, it will behave as a single-turn secondary winding inducing unwanted AC voltages into the measuring circuit. Use of a twisted-pair will reduce the loop area and adjacent twists will cancel any induced voltages. If problems with stray pick-up are encountered, it is recommended that a shielded twisted-pair cable be used with the screen connected to the **Lo** terminal at the source as shown in Figure 3-2.

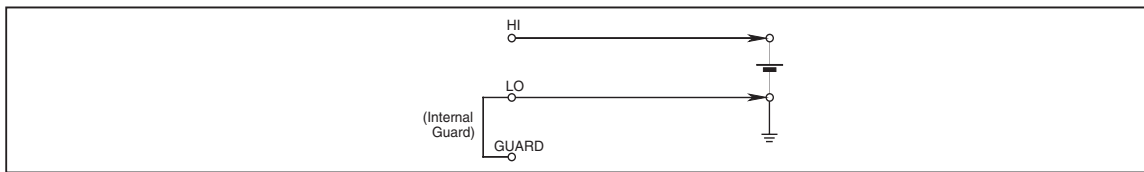

Figure 3-1. Simple Lead Connections

adj059f.eps

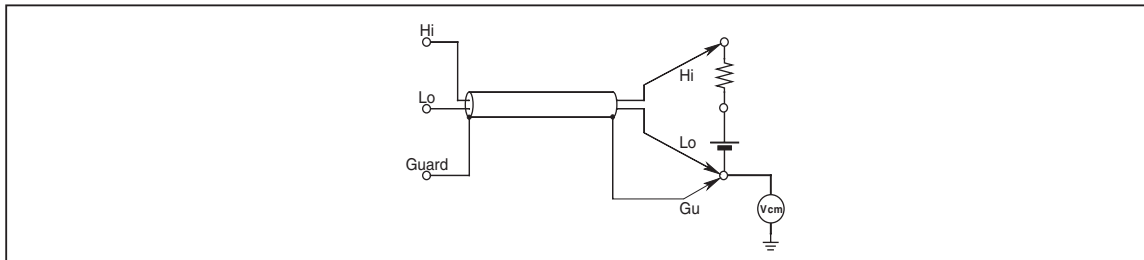

Figure 3-2. Twisted-Pair Cable Connections

adj060f.eps

Common Mode Rejection - Use of External Guard Connection

Use the **Guard** terminal with External Guard selected when the source to be measured presents an unbalanced impedance to the measuring terminals, and common mode voltages are present. Regardless of how the **Hi** and **Lo** terminals are connected, the **Guard** terminal should be referred to the source of common mode voltage, as shown in Figure 3-3. This ensures that errors caused by common mode currents in the measuring circuit are minimized by providing a separate common mode current path.

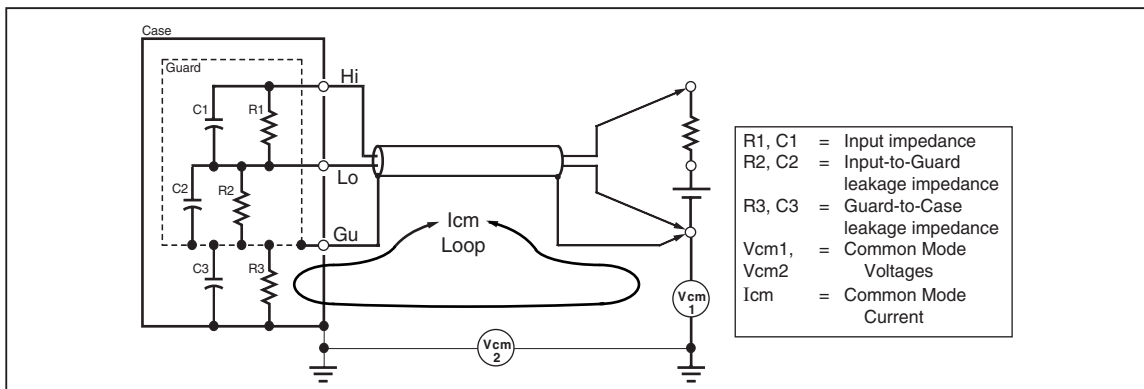

Figure 3-3. External Guard Connections

adj061f.eps

Internal Guard Connections

External Guard not selected: The Guard terminals on the front and rear panels are isolated from each other and from any internal connection. The internal guard shields and tracks are connected directly to the internal 0V.

External Guard selected: The internal guard shields and tracks are disconnected from the internal 0V, and connected to the **Guard** terminal of the selected front or rear input.

Ohms Guard: In the Ohms or PRT Functions the External Guard selection is modified to provide an Ohms Guard. In these cases the internal guard shields, tracks and selected front or rear Guard terminal are connected to the internal 0V.

The simplified diagram in Figure 3-4 illustrates the switching arrangement.

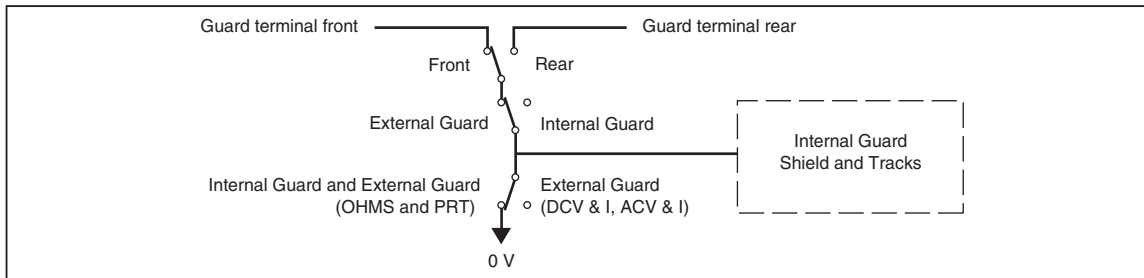

Figure 3-4. Internal Guard Connections

adj062f.eps

Selecting External Guard (ExGd)

See Figure 3-3 for a description of External Guard Connections.

To select **External Guard**:

1. Press Input key to enter the INPUT menu.

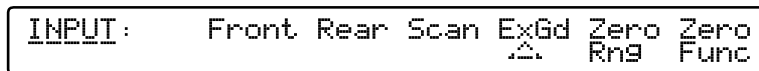

INPUT Menu

adj064f.eps

2. Press the menu key ExGd to toggle the Multimeter's Guarding options.

The ExGd annunciator on the left-hand display indicates that External Guarding is selected.

AC Voltage

Press the ACV key to see the ACV menu.

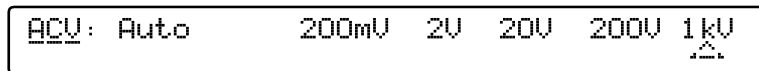

ACV Menu

adj066f.eps

- ACV This function provides both 2-wire and 4-wire measurements, in decade ranges from 200mV to 200V and a 1kV range.
- Auto To cancel autoranging and enter a manually selected range, press any range selection or the Auto softkey. The Multimeter enters the selected range or reverts to the auto-selected range.

ACV Configuration (4 wire Sense, Resolution, RMS Filtering, Transfer mode, DC-Coupled and Spot Frequency)

Press the Config key to see the ACV CONFIG menu.

```
ACV_CONFIG: 4wV Res1 Filt Tfer DCcP Spot
```

adj067f.eps

ACV CONFIG Menu

- 4wV** Allows operation with calibrators which provide a remote 4 wire sensing capability by providing, at an internal reference plane within the DMM, connections between **INPUT HI** and **SENSE HI** and between **INPUT LO** and **SENSE LO**. Use of an internal reference plane can be helpful in 4wire AC, AC transfer, or 4wire AC – DC transfer applications.

The 4wV annunciator in the left-hand display indicates that 4-wire sensing is active.
- Res1** Provides selection of the resolution for subsequent readings.
- Filt** Provides selection of various filters for the RMS converter, allowing measurements to be made down to the chosen filter frequency. One of four filters is always in circuit. The 40Hz filter is the default selection at power on.

The Filter annunciator on the left-hand display indicates that the filter is active and indicates its frequency.
- Tfer** Controls the internal electronic AC-DC transfer for AC measurement, improving linearity and temperature performance at the expense of read rate. Tfer on is the default selection at power on.

The Tfer annunciator on the left-hand display indicates that internal AC-DC transfer is active.
- DCcP** DC couples the input circuitry to include DC signal components in the AC measurement when selected.

The DC coupled annunciator in the left-hand display indicates active state.
- Spot** Selects the Spot Frequency measurement mode, where calibration constants derived for up to six previously calibrated spots (Sp1 thru 6) are applied for signal frequencies within $\pm 10\%$ of a spot frequency. This can be used to significantly reduce flatness errors in Sine Wave (low crest factor) measurement applications.

The Spot annunciator on the left-hand display indicates that Spot corrections are active.

ACV Resolution

Press the Resl key to see the ACV RESL menu:

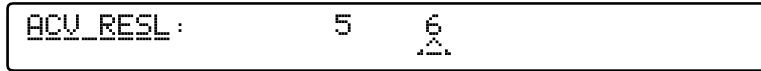

ACV RESL Menu

adj068f.eps

- 5 5-1/2-digits resolution
- 6 6-1/2-digits resolution

To revert to the ACV CONFIG menu, press the Config key.

ACV Filter

Press the FilT key to see the ACV FILT menu:

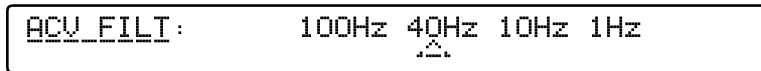

ACV FILT Menu

adj069f.eps

The ACV FILT menu allows selection of one of four RMS filters. The indicated value is the lowest signal frequency that can be measured without degradation of accuracy and excessive reading variation.

The default setting at power on is 40 Hz.

Note

Measurement results are invalid when using internal triggers in Transfer mode with the 1 Hz filter selected. For valid results, use Ext Trig and Sample, or trigger via the IEEE-488 interface.

AC Voltage - Movement between Menus

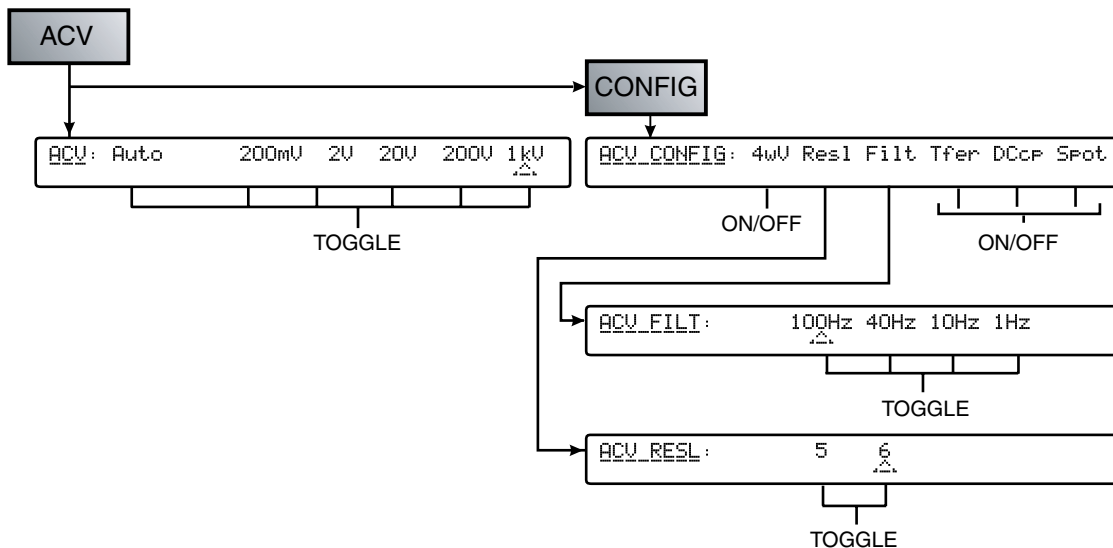

AC Voltage Menu Tree

adj070f.eps

Measuring AC Voltage

Induced Interference

If interference signals are present or lead pickup takes place during AC measurements, any induced interfering signals will combine with the signal being measured and result in measurement errors. In some circumstances, it may be possible to filter out the unwanted external signals, but it is generally more effective to reduce the interference before it is induced. This is most easily accomplished by operating in a quiet environment, e.g., using a screened cage and, if possible, using twisted or shielded measurement leads as discussed below.

Common Mode Rejection

The principles of external guarding, outlined in the description of DC voltage measurement, apply generally to AC voltage measurement. For AC a further advantage can be gained by using the external guard as a shield for the input leads.

Lead Considerations

In all cases, AC voltage measurement accuracy is improved by shortening the leads to the minimum practical length to reduce lead capacitance, lead inductance and loop area. Shielded twisted pair leads are recommended for low frequency measurements and coaxial leads are recommended for low and high frequency measurements. Users should take care to avoid measurement errors from the interaction of lead capacitance and inductance with any source output impedance. Additional information and guidance is available in the Fluke publication Calibration: Philosophy in Practice (ISBN 0-9638650-0-5).

Resistance

Press Ω to go to the OHM menu.

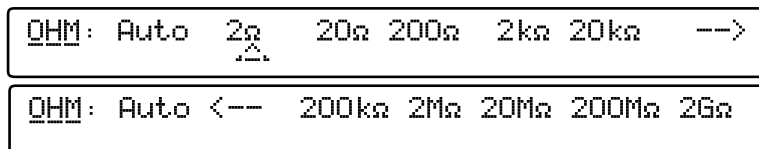

OHM Menu

adj073f.eps

- | | |
|------|---|
| OHM | This function provides both 2-wire and 4-wire measurements, in decade ranges from <u>2Ω</u> to <u>2GΩ</u> . |
| Auto | To cancel autoranging and enter a manually selected range, press any range selection or the Auto softkey. The Multimeter enters the selected range or reverts to the auto-selected range. |

OHMS Configuration (Resolution, Filter, Fast, Low Current and 4-Wire Operation)

Press the Config key to see the OHMS CONFIG menu.



adj074f.eps

OHM CONFIG Menu

- Res1** Provides selection of the resolution for subsequent readings.
- Filt** Controls a single-pole analog filter for increased noise rejection.
The Filter annunciator on the left-hand display indicates that the filter is active.
- Fast** Select a higher read rate. This will result in an increase in uncertainty due to noise.
The Fast annunciator on the left-hand display indicates that the higher read rate is active.
- LoI** Controls the measurement currents. The current in use for the selected range is indicated in the left-hand display together with the maximum voltage that will appear across the measured resistance at full scale.

Note

The pole or time constant of the filter is formed by a Capacitance of 22 nF across the resistor under test.

Note

Low Current resistance measurement may be desirable to reduce any self-heating in the device under test or to avoid conduction of any parallel semi-conductor junction.

- 4wΩ** Selects 4-wire resistance measurements in which the stimulus current is fed through the test resistance from the instrument's **INPUT Hi** and **Lo** terminals. The resulting potential difference is sensed by the **SENSE Hi** and **Lo** terminals. Otherwise all measurements are 2-wire, current being sourced and potential differenced sensed from the **INPUT Hi** and **Lo** terminals.
The 4wΩ annunciator in the left-hand display indicates that 4 wire sensing is active.

OHMS Resolution

Press the Resl key to see the OHMS RESL menu:

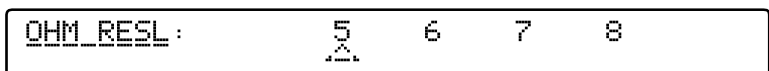

adj075f.eps

OHM RESL Menu

- 5 5-1/2-digits resolution
- 6 6-1/2-digits resolution
- 7 7-1/2-digits resolution
- 8 8-1/2-digits resolution

Refer to table 3-1 for the ADC integration times applicable to the various resolution and Fast On/Off settings.

To revert to the OHMS CONFIG menu, press the Config key.

Ohms - Movement between Menus

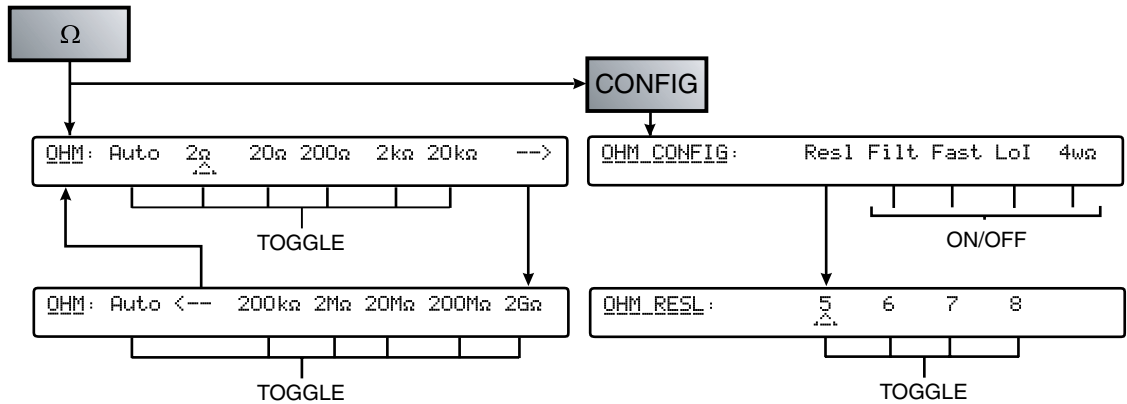

adj076f.eps

Ohms Movement Between Menu

High Voltage Ohms

Press the Ω PLUS key to see the expanded Ohms selection for True Ohms function and the High Voltage Ohms function. Press HiV Ω key to see the HiV Ω menu:

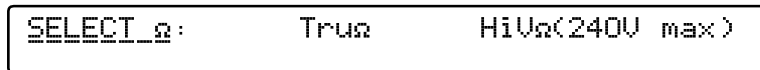

adj077f.eps

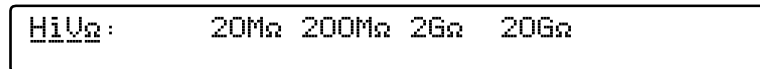

adj078f.eps

HiV Ω Menu

The function provides both 2-wire and 4-wire measurements of resistance, in decade ranges from 20M Ω to 20G Ω . The measurement is performed at High Voltage using a current source with high compliance. The resulting increase in Current through the unknown resistor is valuable to the reduction of leakage and bias current uncertainties. The function may also be used alongside the normal Ohms function to determine Voltage Coefficient in the unknown resistor.

The MAXIMUM voltage that could appear across the measured resistor is 240 V. No autoranging is provided in this function.

⚠️ ⚠️ WARNING

DANGER OF LETHAL ELECTRIC SHOCK

To avoid LETHAL electrical shock DO NOT CONNECT EXTERNAL CAPACITANCE greater than 50 nF to the Multimeter terminals.

The maximum voltage across the measured resistor or open Multimeter terminals while using the HiV Ω function is 240 V. The maximum current that the Multimeter will source while using HiV Ω is 10 μ A (Lo to Hi), or 2.0 mA (Guard to Hi if Ext Guard is selected). These characteristics are not considered “Hazardous Live” within the Safety standards applied to this instrument. However, capacitors (>50 nF) external to the Multimeter could accumulate LETHAL charge while making a HiV Ω measurement. DO NOT TOUCH the Multimeter terminals or circuitry under test unless you are sure it is safe to do so.

⚠⚠ CAUTION – HIGH VOLTAGE

To avoid equipment damage when using the HiVΩ function make sure that circuits or components connected to the Multimeter can withstand at least 240 V dc.

HiVΩ Configuration (Resolution, Filter, and 4-Wire Operation)

Press the Config key to see the HiVΩ CONFIG menu.

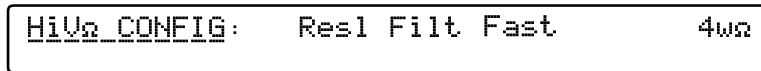

adj079f.eps

HiVΩ CONFIG Menu

- Res1** Provides selection of the resolution for subsequent readings.
- Filt** Controls a single-pole analog filter for increased noise rejection.
The Filter annunciator on the left-hand display indicates that the filter is active.

Note

The pole or time constant of the filter is formed by a Capacitance of 22 nF across the resistor under test.

- Fast** Select a higher read rate. This will result in an increase in uncertainty due to noise.
- 4wΩ** Selects 4-wire resistance measurements in which the stimulus current is fed through the test resistance from the instrument's **INPUT Hi** and **Lo** terminals. The resulting potential difference is sensed by the **SENSE Hi** and **Lo** terminals. Otherwise all measurements are 2-wire, current being sourced and potential difference being sensed from the **INPUT Hi** and **Lo** terminals.

HiVΩ Resolution

Press the Res1 key to see the HiVΩ RESL menu:

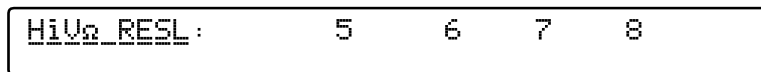

adj080f.eps

HiVΩ RESL Menu

- 5 5-1/2-digits resolution
- 6 6-1/2-digits resolution
- 7 7-1/2-digits resolution
- 8 8-1/2-digits resolution

Refer to table 3-1 for the ADC integration times applicable to the various resolution and Fast On/Off settings.

To revert to the HiVΩ CONFIG menu, press the Config key.

To revert to the HiVΩ menu menu from either HiVΩ RESL or HiVΩ CONFIG, press the HiVΩ menu key.

HiVΩ - Movement between Menus

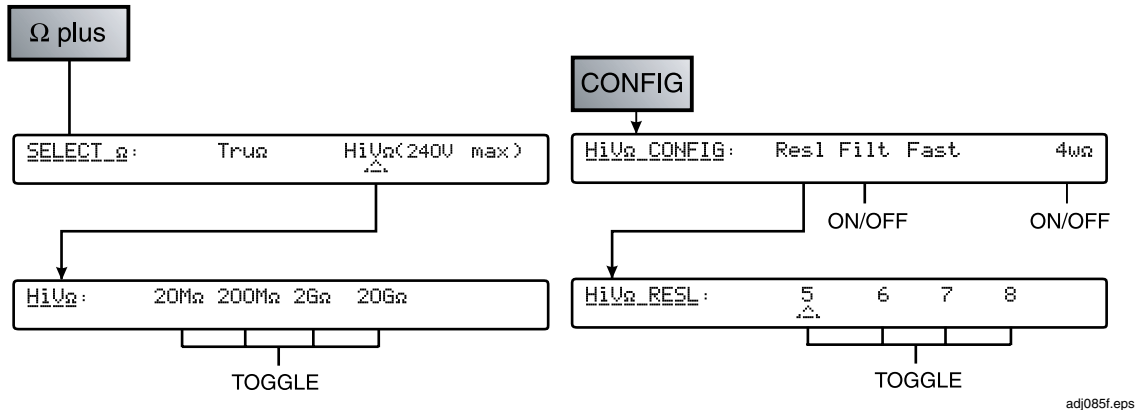

HiVΩ Movement Between Menu

True Ohms

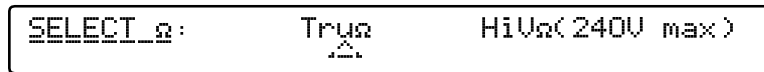

TruΩ Menu

Press the Ω PLUS key to see the expanded Ohms selection for True Ohms function and the High Voltage Ohms function. Press the Tru Ω key for the Tru Ω menu.

The TruΩ mode takes two measurements per reading. The second measurement is made with the current reversed relative to the first measurement. The two measurements are combined to eliminate the effects of any external EMFs that may be present.

TruΩ This function provides only 4-wire measurements of resistance, in decade ranges from 2Ω to 20kΩ. The stimulus current is fed through the test resistance from the instrument's **INPUT Hi** and **Lo** terminals and the resulting potential difference is sensed by the **SENSE Hi** and **Lo** terminals

Auto To cancel autoranging and enter a manually selected range, press any range selection or the Auto softkey. The Multimeter enters the selected range or reverts to the auto-selected range.

TRUΩ Configuration (Resolution, Fast, and Low Current)

Press the Config key to see the TRUΩ CONFIG menu.

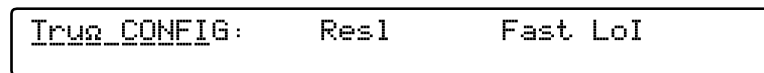

TRUΩ CONFIG Menu

Res1 Provides selection of the resolution for subsequent readings.

Fast Select a higher read rate. This will result in an increase in uncertainty due to noise.

LoI Controls the measurement currents. The current in use for the selected range is indicated in the left-hand display together with the maximum voltage that will appear across the measured resistance at full scale.

TRUΩ Resolution

Press the Resl key to see the TRUΩ RESL menu:

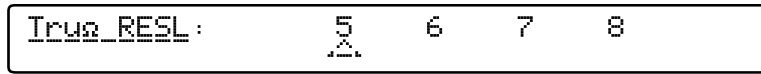

TRUΩ RESL Menu

adj083f.eps

- 5 5-1/2-digits resolution
- 6 6-1/2-digits resolution
- 7 7-1/2-digits resolution
- 8 8-1/2-digits resolution

Refer to table 3-1 for the ADC integration times applicable to the various resolution and Fast On/Off settings.

To revert to the TRUΩ CONFIG menu, press the Config key.

TRUΩ - Movement between Menus

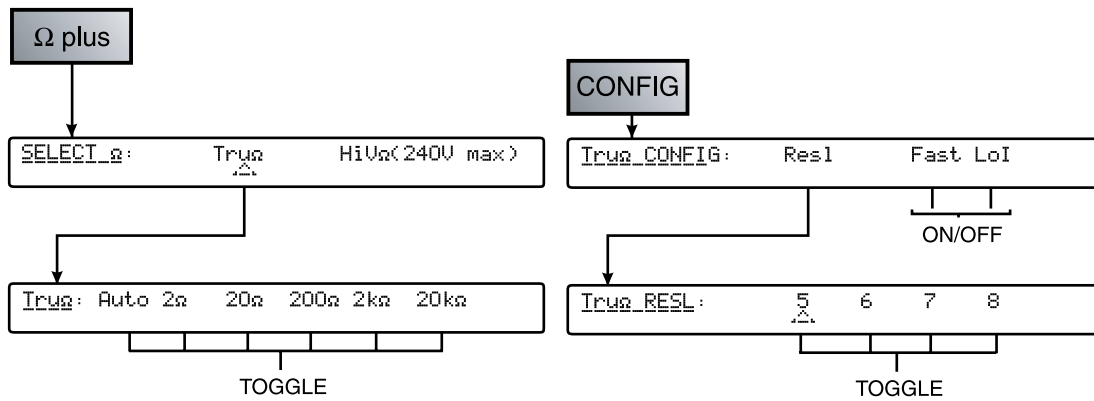

TRUΩ Movement Between Menu

adj086f.eps

Measuring Resistance

2-Wire Measurements

For many applications the simple 2-wire arrangement will be adequate. See Figure 3-5. However, the value displayed will include the resistance of the connecting leads.

Use a shielded twisted-pair cable, preferably of PTFE insulation, to reduce induced voltages, induced charge and shunt leakage resistance, particularly where Rx is high.

2-wire resistance measurement is not available when in TruΩ mode and is not well suited to use in the 2Ω range. In the latter case zero compensation for lead and internal resistance contributions may limit full-scale readout. 2-wire measurements above 1.5Ω should be made using higher ranges.

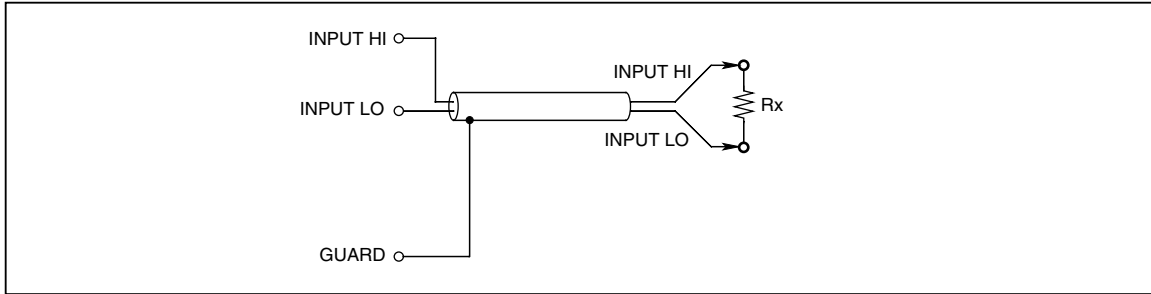

Figure 3-5. 2-Wire Measurements

adj091f.eps

4-wire Measurements

With a 4-wire connection the lead resistances have negligible effect and only the value of R_x is displayed.

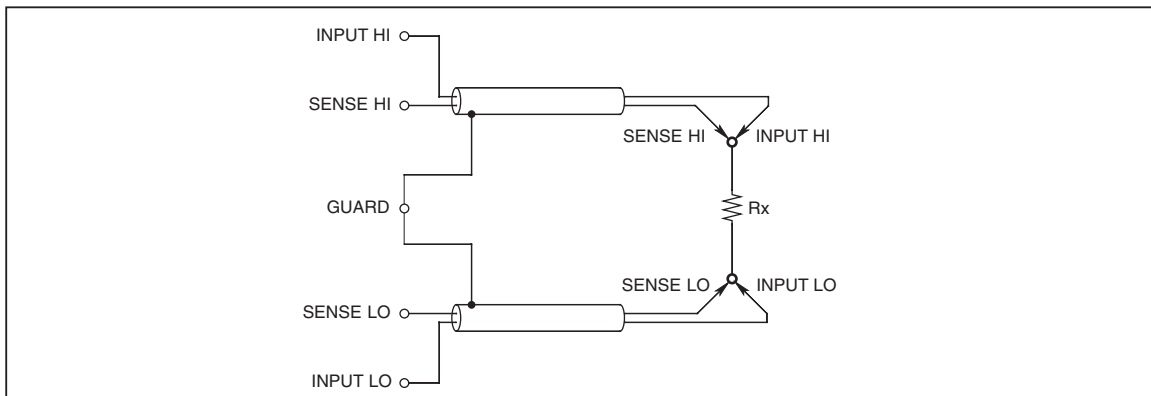

Figure 3-6. 4-Wire Measurements

adj092f.eps

4-wire High Resistance Measurements

When making very high resistance measurements above about $1\text{ M}\Omega$, a metal screen can be wrapped around the resistor to reduce noise, usually caused by charge injection. Connecting the **GUARD** terminal to the screen will intercept leakage via the screen (in parallel with the unknown resistor). The resistor under test should not be grounded, as this will make the measurement noisier.

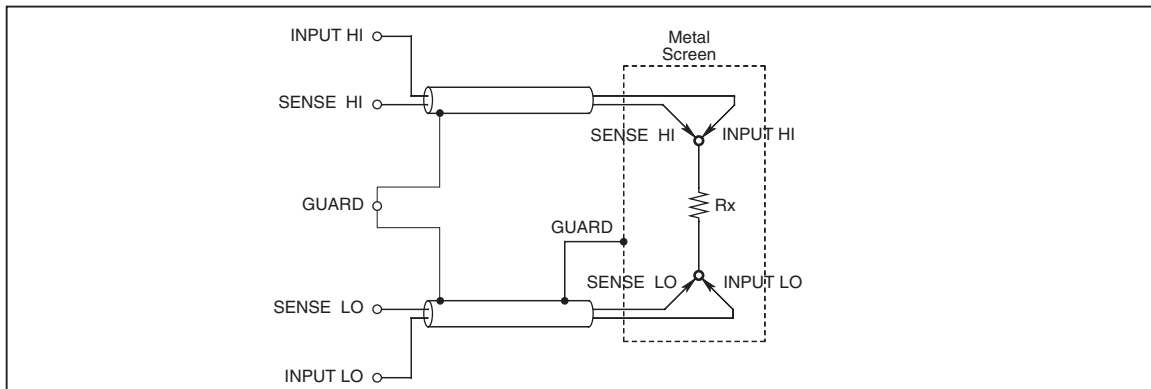

Figure 3-7. 4-Wire High Resistance Measurements

adj093f.eps

4-wire Resistance Zero

For accurate measurements of resistance it is essential that a correctly connected zero source be used when performing an Input-Zero operation before making a series of measurements. The preferred arrangement shown in Figure 3-8 ensures that thermal and induced EMF effects, and bias current effects, associated with the multimeter and the measurement cables are eliminated.

Two precision 4wire short accessories are supplied as standard within the 8508A – LEAD leadkit. Fitted over the Input Hi, Input Lo, Sense Hi and Sense Lo terminals these provide a convenient means of zeroing the 8508A inputs at the terminals. Use of the 4-wire short device at the multimeter terminals does not address potential sources of error within measurement cables.

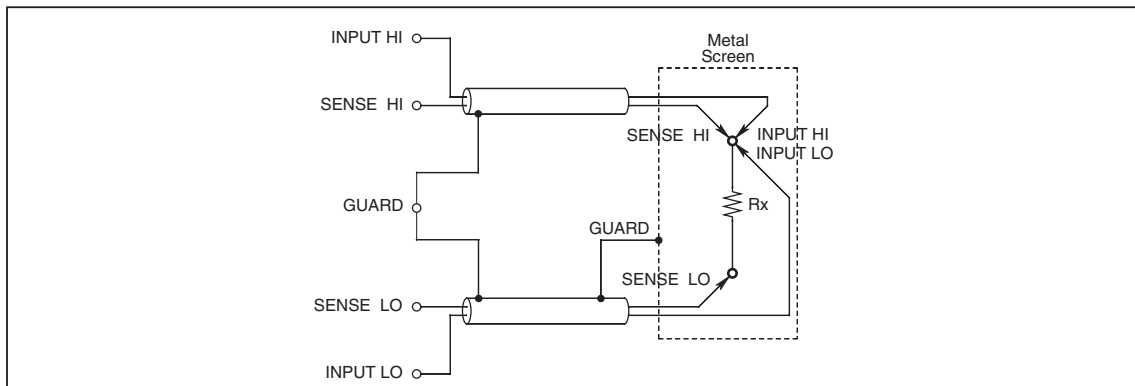

Figure 3-8. 4-Wire Resistance Zero Measurements

adj094f.eps

Ω Guard

In the resistance function with Ext Grd selected the Guard terminal functions as **Ω Guard**. Using the Guard terminal as **Ω Guard**, the **Ω Guard** feature can be used to make 'in-circuit' resistance measurements by guarding out parallel resistance paths so that only the value of Rx will be displayed.

Similarly, **Ω Guard** can be used to reduce the settling time if Rx is shunted by any capacitance and a suitable tapping point is available. The connections for making **Ω Guard** measurements are shown in Figure 3-9. Selection of Ext Grd is required.

Providing that Ra and Rb are no less than 1 k Ω (10 k Ω on 2M Ω range and above), and the **Ω Guard** resistance (Rg) is less than 1 Ω ; the actual value can be calculated from the displayed value Rd by:

$$R_x = R_d \times (1 + E)$$

Deviation fraction 'E' can be found within 1 % by the simplified formula:

$$E = (R_d \times R_g) / (R_a \times R_b)$$

(Where Rg is the **Ω Guard** lead-resistance from the junction of Ra and Rb)

Example:

If Rd = 100 Ω , Rg = 1 Ω , Ra = Rb = 10 k Ω , then the value of E is given by:

$$E = (100 \times 1) / (10 \text{ k} \times 10 \text{ k}) = 10^{-6} \text{ (1 ppm of readings)}$$

The value of Rx is thus given by:

$$\begin{aligned} R_x &= 100 \times (1 + 10^{-6}) \text{ Ohms,} \\ &= 100.0001 \text{ Ohms} \end{aligned}$$

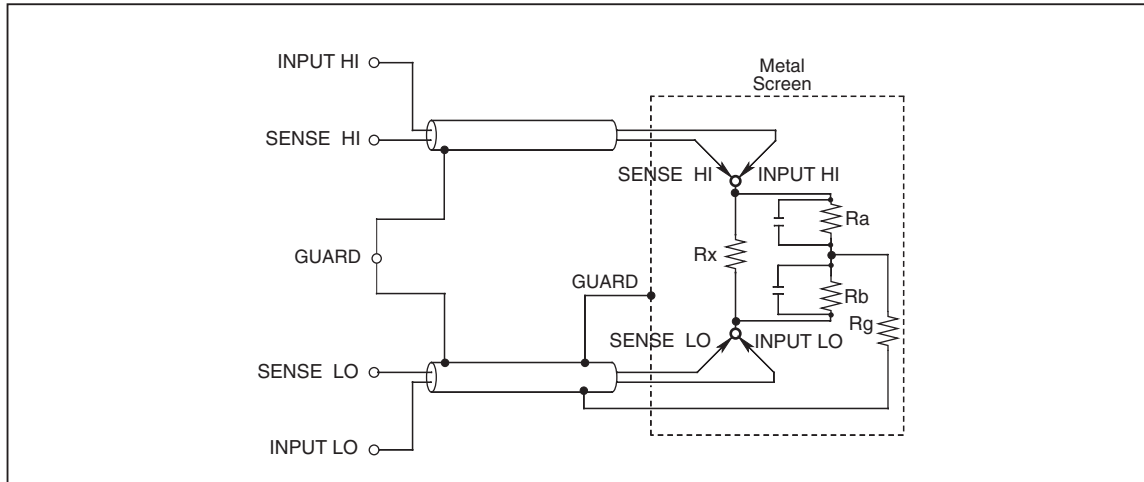

Figure 3-9. Ω Guard Measurements

adj095f.eps

Internal Guard Connections

External Guard not selected: In the Ohms or PRT Functions the Guard terminals on the front and rear panels are isolated from each other and from any internal connection. The internal guard shields and tracks are connected directly to the internal 0 V.

External Guard selected: In the Ohms or PRT Functions selecting the External Guard provides an Ohms Guard function. The internal guard shields, tracks, and the selected front or rear Guard terminal are connected to the internal 0 V.

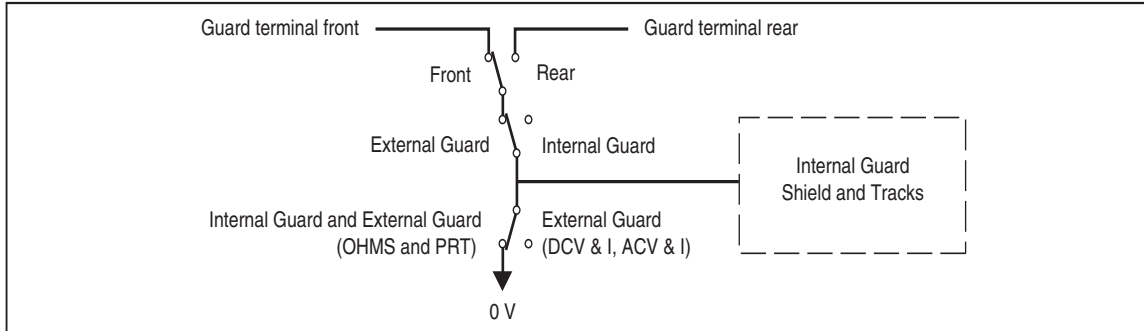

Figure 3-10. Internal Guard Connections

adj062f.eps

Selecting External Guard (ExGd)

See Figure 3-9 for connections when using the Ω Guard feature.

To select **External Guard**:

1. Press Input key to enter the INPUT menu.

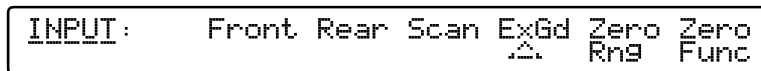

INPUT Menu

adj064f.eps

2. Press the menu key ExGd to toggle the Multimeter's Guarding options.

The ExGd annunciator on the left-hand display indicates that External Guarding is selected.

DC Current

Press the DCI key to show the DCI menu.



adj097f.eps

DCI Menu

- DCI** This function provides measurements, in decade ranges from 200µA to 20A. (NOTE: the 20A range is only available on the front terminals. The front current terminal is not fused.)
- Auto** To cancel autoranging and enter a manually selected range, press any range selection or the Auto softkey. The Multimeter enters the selected range or reverts to the auto-selected range.

DCI Configuration (Resolution, LP Filtering and Fast)

Press the Config key to see the DCI CONFIG menu. Resl is a *menu* keys; *Filt*s and *Fast* are *toggle* keys.

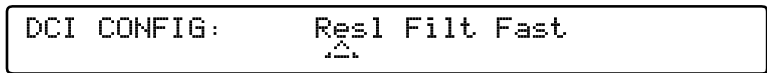

adj098f.eps

DCI Configuration Menu

- Resl** Provides selection of the resolution for subsequent readings.
- Filt** Controls a two-pole analog filter for increased noise rejection.
The Filter annunciator on the left-hand display indicates that the filter is active and indicates its cut-in frequency.
- Fast** Select a higher read rate. This will result in an increase in uncertainty due to noise.
The Fast annunciator on the left-hand display indicates that the higher read rate is active.

DCI Resolution

Press the Resl key to see the DCI RESL menu:

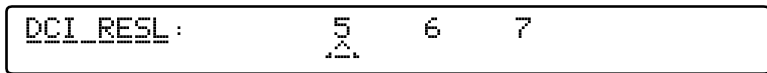

adj099f.eps

DCI RESL Menu

- 5 5-1/2-digits resolution
6 6-1/2-digits resolution
7 7-1/2-digits resolution

Refer to table 3-1 for the ADC integration times applicable to the various resolution and Fast On/Off settings.

To revert to the DCI CONFIG menu, press the Config key.

DC Current - Movement between Menus

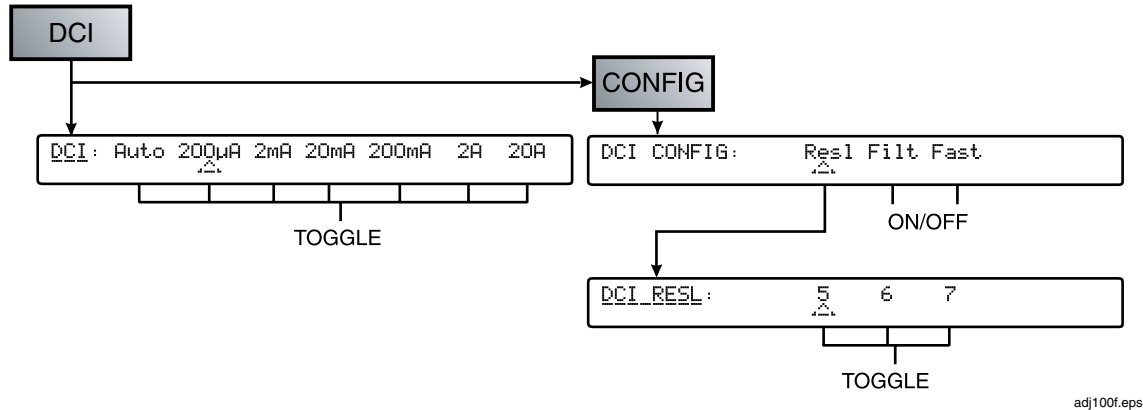

DCI Movement Between Menu

Measuring DC Current

Insert the Multimeter in the current path via its **INPUT A** and **INPUT Lo** terminals, so that conventional current flows from the source Hi into the Multimeter's **A** terminal and back to the source Lo out of the **Lo** terminal.

Similar connection considerations are required for DC current measurement as for DC voltage measurement. Use shielded twisted-pair cable to reduce induced interference signals, and connect **Guard** to the source of common mode voltage, to provide a separate common mode current path.

⚠️ ⚠️ WARNING – HIGH CURRENT FLOW

To avoid fire hazard make sure that conductors of adequate guage are used when making current measurement. High Current can cause excessive heating of underated conductors and may cause a fire.

Note

The Current path between DMM terminals is not made when the Current functions are not in use or when Front or Rear terminals are deselected.

Note

Maximum Input Current capability and protection. The front input terminals may be used to measure currents up to 20 A. The front input A terminal protection is automatic and self-resetting, and does not interrupt current flow. Damage is likely to occur if more than 20 A is applied.

The Rear input terminals may be used to measure currents up to 2 A only. The rear input A terminal is protected by a fuse mounted on the rear panel.

AC Current

Press the ACI key to show the ACI menu:

```
ACI: Auto 200µA 2mA 20mA 200mA 2A 20A
      ▲
```

adj101f.eps

ACI Menu

- ACI** This function provides measurements, in decade ranges from 200µA to 20A. (NOTE: the 20A range is only available on the front terminals. The front current terminal is not fused.)
- Auto** To cancel autoranging and enter a manually selected range, press any range selection or the Auto softkey. The Multimeter enters the selected range or reverts to the auto-selected range.

ACI Configuration (Resolution, RMS Filtering and DC Coupled)

Press the Config key to see the ACI CONFIG menu:

```
ACI_CONFIG: Resl Filt DCcP
```

adj102f.eps

ACI CONFIG Menu

- Resl** Provides selection of the resolution for subsequent readings.
- Filt** Provides selection of various filters for the RMS converter, allowing measurements to be made down to the chosen filter frequency. One of four filters is always in circuit. The 40Hz filter is the default selection at power on.
The Filter annunciator on the left-hand display indicates that the filter is active and indicates its frequency.
- DCcP** Controls the measurement-coupling configuration.
The DC coupled annunciator in the left-hand display indicates active state.

ACI Resolution

Press the Resl key to see the ACI RESL menu:

```
ACI_RESL: 5 6
          ▲
```

adj103f.eps

ACI RESL Menu

This menu offers the following resolution choices:

- 5 5-1/2-digits resolution
- 6 6-1/2-digits resolution

To revert to the ACI CONFIG menu, press the Config key.

ACI Filter

Press the Filt key to see the ACI FILT menu:

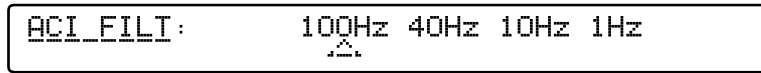

ACI Filt Menu

adj104f.eps

The ACI FILT menu allows selection of one of four RMS filters. The indicated value is the lowest signal frequency that can be measured without degradation of accuracy or excessive reading variation.

AC Current - Movement between Menus

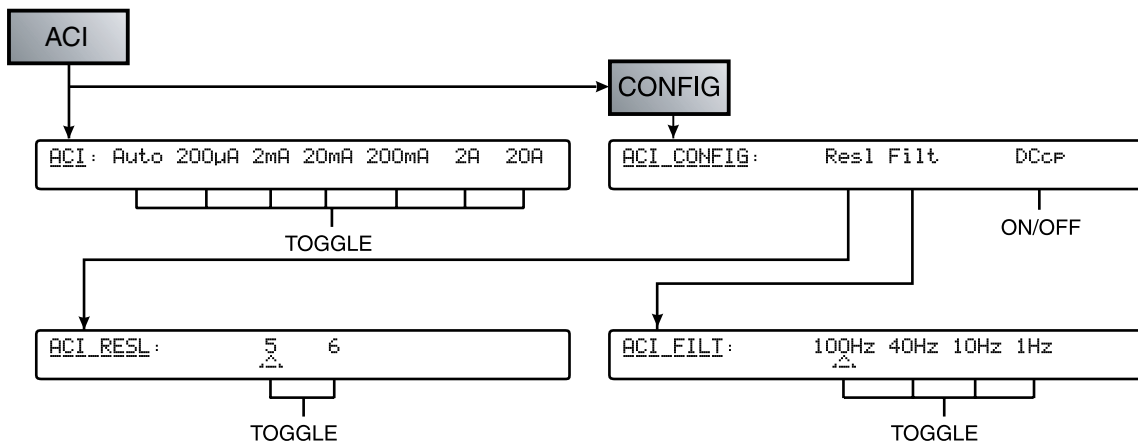

ACI Movement Between Menu

adj100f.eps

Measuring AC Current

Insert the Multimeter in the current path via its **A** and **Lo** terminals.

Similar connection considerations are required for AC current measurement as for AC voltage measurement. Use shielded twisted pair cable to reduce induced interference signals, and connect **Guard** to the source of common mode voltage via the screen, to provide a separate common mode current path. The 8508A is designed to minimise the burden (compliance) voltage generated when making current measurements, thus improving measurement accuracy. However, it is recommended that leads of the minimum practical length be used to reduce lead capacitance, lead inductance and loop area.

⚠️ ⚠️ WARNING – HIGH CURRENT FLOW

To avoid fire hazard make sure that conductors of adequate guage are used when making current measurement. High Current can cause excessive heating of underated conductors and may cause a fire.

Note

The Current path between DMM terminals is not made when the Current functions are not in use or when Front or Rear terminals are deselected.

Note

Lead Impedance - When making AC current measurements pay particular attention to the lead impedance, especially lead capacitance at high frequencies on the lower current ranges. (See "Measuring AC Voltage" earlier in this chapter.)

Note

Maximum Input Current capability and protection - The front input terminals may be used to measure currents up to 20 A. The front input A terminal protection is automatic and self-resetting, and does not interrupt current flow. Damage is likely to occur if more than 20 A is applied.

The Rear input terminals may be used to measure currents up to 2 A only. The rear input A terminal is protected by a fuse mounted on the rear panel.

Temperature

The 8508A provides a temperature readout by measuring the resistance of the connected PRT or SPRT probe, and converting the resistance value to temperature. The multimeter autoranges between the 200 Ω LoI Ω range and the 2k Ω Normal Ω range depending on the resistance value obtained at the temperature being measured.

Press the PRT key to show the PROBE # menu:

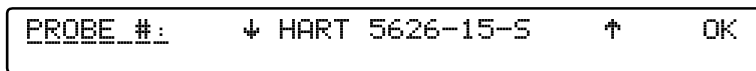

adj105f.eps

Select OK to ensure the probe indicated is selected.

Probe# Menu

PRT This function converts resistance measurements from a connected PRT to temperature. This requires that the characteristics of the probe being used are available for the conversion algorithm. The 8508A will store up to 100 sets of probe characteristics and the first menu encountered is used to select from a scrollable list of entered probe identities.

Once selected, the stored probe characteristics are used to configure the instrument hardware and implement the conversion of subsequent measurements.

Temperature is displayed on the main left-hand display, and the measured resistance value is also displayed on the right hand display.

PRT Configuration (Temperature Units, Resolution, Probe Configuration Management)

Press the Config key to see the PRT CONFIG menu:

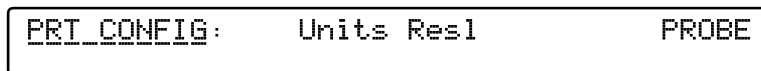

adj106f.eps

PRT CONFIG Menu

- Units** Provides selection for temperature units.
- Res1** Provides selection of the temperature resolution for subsequent readings.
- PROBE** This is the entry point to manage PRT probe information.

PROBE Configuration Management (New, Edit, Delete)

```
PROBE_CONFIG:  Edit  New Delete  Exit
```

PROBE CONFIG Menu

adj107f.eps

The utilization and management of PRT probe data is depends upon a probe identity. For example, before using the edit and delete capabilities a probe identity must be selected. For a new probe, defining an identity is the first step in the sequence of establishing the probe's characteristics.

New PROBE Entry

```
Probe # =          Enter Quit
```

PROBE# Menu

adj108f.eps

For entry of the characteristics of a new PRT probe a **directed sequence** of menus, initiated with a **NEW** command, should be followed. The first menu establishes the identity of the probe using the alphanumeric keyboard entry system. (NOTE: no duplication checks are made on the identity.)

```
CONNECTION:      2wr  3wr  4wr
```

Connection Menu

adj109f.eps

Selection of the connection method will determine the measurement configuration that is used by the Multimeter. This characteristic cannot be modified via the **Edit** capability.

- 2wr 2-wire probe configuration. Resistance measurements will be made using the 2-wire connection, with a single polarity stimulus current.
- 3wr 3-wire probe configuration. An equivalent 3-wire measurement will be made by automatically taking a reading with the resistance circuits in 2-wire with a single polarity stimulus current and also in 4-wire with polarity reversal of the stimulus current, and performing a calculation. Equal resistance is assumed for all three probe-leads. Input zeros for 2-wire and 4-wire resistance must be performed prior to the selection of the PRT as these are used in the calculation to remove offsets and internal lead resistance.
- 4wr 4-wire probe configuration. Resistance measurements will be made using the 4-wire connection, with a polarity reversal of the stimulus current.

```

CONVERSION:  SPRT      cvd-  cvd-  cvd
              ITS90     α      A      df1t
    
```

adj110f.eps

Conversion Menu

Select the conversion algorithm to be applied. This characteristic cannot be modified via the Edit capability. A measurement annunciator in the left-hand display indicates the active conversion algorithm.

SPRT ITS90 This algorithm converts resistance to temperature according to the ITS-90 specifications for SPRTs. For details see the NIST Technical Note 1265, *Guidelines for Realizing the International Temperature Scale of 1990*. The user-defined parameters for the ITS-90 conversion include two subranges which are entered in subsequent conversion specific menus.

cvd-α This algorithm converts resistance to temperature using the Callender-Van Dusen equations. The user-defined parameters are supplied in the Alpha(α), Delta(δ), and Beta(β) format and are entered in subsequent conversion specific menus.

cvd-A This algorithm converts resistance to temperature using the Callender-Van Dusen equations. The user-defined parameters are supplied A, B, C coefficients and are entered in subsequent conversion specific menus.

Note

The coefficients Alpha(α), Delta(δ), Beta(β) and A, B, C belong to reciprocally related polynomial expressions. Either may be used according to preference or available data.

cvd-df1t This algorithm converts resistance to temperature using the Callender-Van Dusen equations. The only user-defined parameter is the R_0 value entered in a subsequent conversion specific menu. The other coefficients are defaulted to A = 3.9083E-3, B = -5.775E-7, C = -4.183E-12.

Coefficient Entry for a New PROBE

On selection of a conversion method the algorithm specific coefficients are set to default values. The subsequent menus to modify these coefficients are conversion specific. The default value for the coefficient may be entered with a labeled softkey.

SPRT ITS90

Coeff R ₀ = ? 1 of 6	Enter Df1t
Coeff a ₊ = ? 2 of 6	Enter Df1t
Coeff b ₊ = ? 3 of 6	Enter Df1t
Coeff c ₊ = ? 4 of 6	Enter Df1t
Coeff a ₋ = ? 5 of 6	Enter Df1t
Coeff b ₋ = ? 6 of 6	Enter Df1t

adj111f.eps

Coefficient Menus

The R_{tp} is the resistance of the probe at the triple point of water. For a probe calibrated for the subrange W7 the coefficient a^+ is equivalent to a_7 , coefficient b^+ is equivalent to b_7 , and c^+ to c_7 . Similarly for a probe calibrated for the subrange W4 the coefficient a^- is equivalent to a_4 , and b^- to b_4 . Other subrange coefficients can be substituted for W4 and W7 coefficients. Unused coefficients should be defaulted to 0.

cvd- α

A similar group of menus appear for the cvd-A conversion and for the cvd-dflt conversion only the Ro menu appears.

On entry of the final coefficient a check is made against limits for correct algorithm operation. A message is displayed indicating the coefficients in error. Coefficient values are not updated.

Measuring Temperature

Connect the PRT or SPRT probe to the multimeter in the same way as when making resistance measurements, using the appropriate connection shown in figure 3-11. The corresponding 2, 3, or 4-wire measurement configuration will be automatically set based on the stored probe characteristics for the probe selection made. Selection of EXT Grd is recommended.

Note:

Any input zero operations required must be performed in the resistance function on the 200Ω LoI Ω and $2k\Omega$ Normal Ω ranges prior to entering the PRT function. Input zeros must be performed in both 2-wire and 4-wire resistance modes when using the 3-wire PRT configuration.

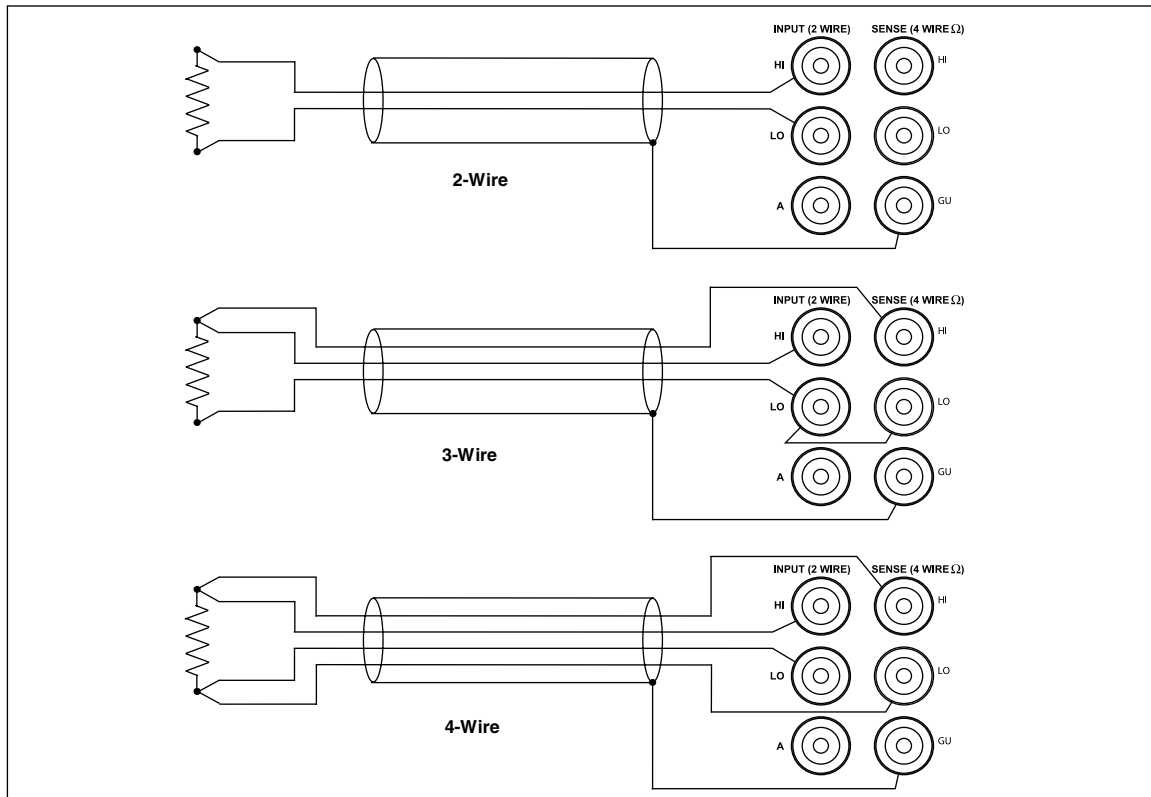

Figure 3-11. PRT Connections

adj131f.eps

Multimeter Inputs

Input

The Input key and its menu allow you to select either the Front or Rear panel terminals as the input to the Multimeter: The scan softkey gives access to dual-channel measurement and processing selection which produces a single result.

Using the INPUT Key

Press the Input key to see the INPUT menu:

```
INPUT:  Front Rear Scan ExGd Zero Zero  
                Rng  Func
```

adj113f.eps

INPUT key Menu

Front. Selects Front Input terminals only.

Rear. Select Rear Input terminals only.

Note - Total Isolation State

You can put the Multimeter in a state of total isolation by deselecting all the selections on the INPUT and SCAN menus. In this state, the Multimeter has no input.

This state is useful in a remote control system, to isolate the Multimeter from the system's analog bus.

Scan. Readings are taken alternately from each channel, then measurements are combined as per the selection.

Note

Selecting Front or Rear cancels any Scan selection.

ExGd. When On, the internal guards are decoupled from Lo and connected to the Guard terminal. Operation of Guard in the resistance function is modified, and includes Ohms Guard. Refer to the 'making measurements' section for each function for more details.

Zero Rng. Initiates a series of measurements to determine and correct for the Input Zero and save the result in volatile memory. An indication of the application of an input zero will appear on the left-hand display. Independent zero corrections are provided for Front and Rear terminals and, when in Ohms functions, 2 wire and four wire connections and normal and low current operation.

Zero Fnc. Initiates a series of measurements on each range in the function starting with the highest range, to determine and correct for the Input Zero for each range.

Note

Input Zeros - Input zero stores are cleared on power up, and may also be cleared by the user from the CLEAR menu, accessed by pressing the CLEAR key.

SCAN OPERATIONS

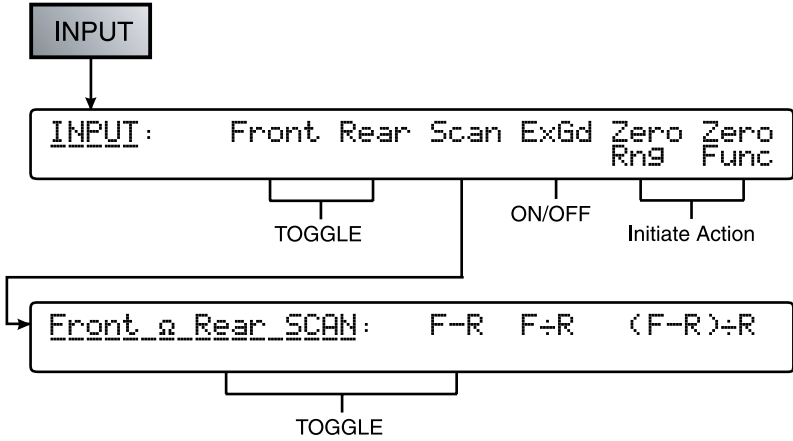

adj128f.eps

Scan Menu

In each of three Scan modes, measurements are taken alternately from the Front and Rear Terminals and are combined mathematically to produce a single result as shown below.

- F-R** Readings are taken alternately from the front terminals and then the rear to produce the displayed result; Front reading – Rear reading.
- F÷R** Readings are taken alternately from the front terminals and then the rear to produce the displayed result; Front reading / Rear reading.
- (F-R)÷R** Readings are taken alternately from the front terminals and then the rear to produce the displayed result; This is the normalized ‘deviation’ value.

Note

Scan of the Current functions - Scan is not available in the ACI and DCI functions.

Note

Scan of the Ohms functions - In the Ohms and HiV Ohms functions the Scan Operation switches both current stimulus and potential difference measurement between the Front and Rear terminals. The Tru Ohms Ratio feature described below scans only the potential difference measurement between Front and Rear terminals, maintaining stimulus current through both Front and Rear terminals.

⚠️ ⚠️ WARNING

DANGER OF LETHAL ELECTRIC SHOCK

To avoid LETHAL electrical shock DO NOT CONNECT EXTERNAL CAPACITANCE greater than 50 nF to the Multimeter terminals.

The maximum voltage across the measured resistor or open Multimeter terminals while using the HiVΩ function is 240 V. The maximum current that the Multimeter will source while using HiVΩ is 10 μA (Lo to Hi), or 2.0 mA (Guard to Hi if Ext Guard is selected). These characteristics are not considered “Hazardous Live” within the Safety standards applied to this instrument. However, capacitors (>50 nF) external to the Multimeter could accumulate LETHAL charge while making a HiVΩ measurement. DO NOT TOUCH the Multimeter terminals or circuitry under test unless you are sure it is safe to do so.

⚠ CAUTION – HIGH VOLTAGE

To avoid equipment damage when using the HiV Ω function make sure that circuits or components connected to the Multimeter can withstand at least 240 V dc.

Note

Scan of Temperature Measurement - Scan Mode is not available in the PRT Function. Temperature Measurements from two PRTs (each with its own linearization coefficients) connected to the Front and Rear Terminals may however be compared under remote control of the DMM.

Tru Ohms Ratio

When the Tru Ohms the Scan Mode of operation is selected a stimulus current (of alternating polarity) is applied through both resistors simultaneously, and the potential difference measured across the resistors is scanned between the Front and Rear Terminals, as shown in figure 3-12. This measurement technique can be beneficial for lower value resistance measurements between an unknown and a reference resistor, and reduces self heating (power) modulation that would otherwise result from scanning the stimulus current between the two resistors under test.

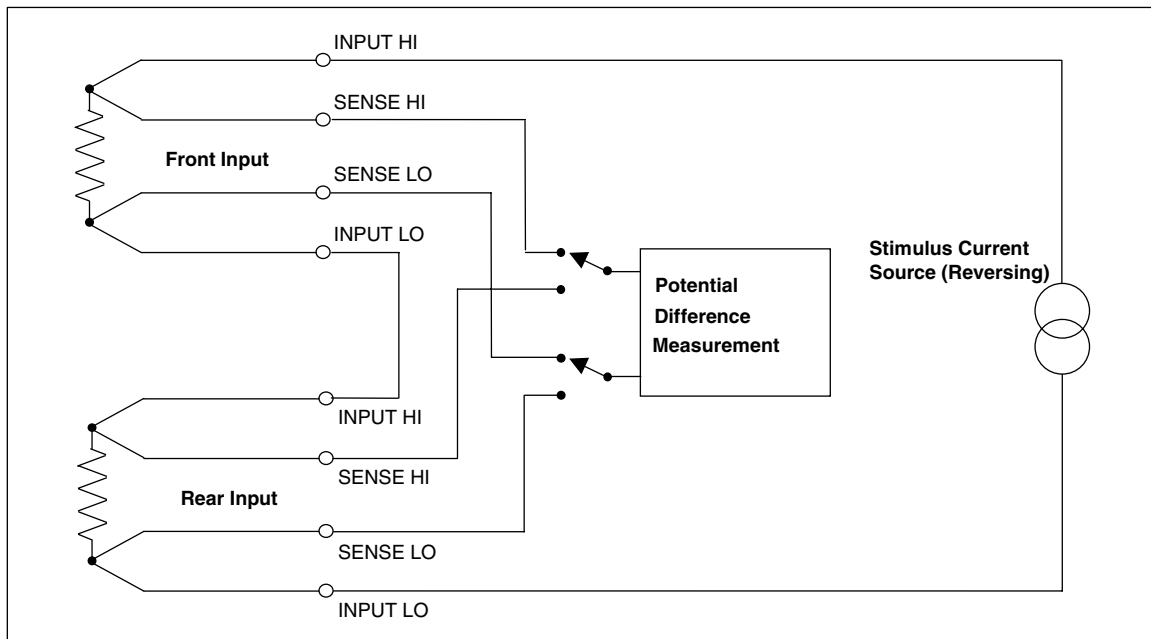

Figure 3-12. Tru Ω Ratio Measurements

adj132f.eps

The sequence of measurement is:

1. Set Forward Current, Measure potential difference at Rear.
2. Set Reverse Current, Measure potential difference at Rear.
3. Set Forward Current, Measure potential difference at Front.
4. Set Reverse Current, Measure potential difference at Front.

Autorange is not available in this mode.

Monitoring Modes

Monitor Key

Press the Monitor key to display MONITOR menu:

```
MONITOR:  Freq Devn Limit Max Min PkPk
```

MONITOR menu

adj116f.eps

Displaying Signal Frequency

When measuring AC voltage or current, select the Freq key to display the frequency corresponding to the rms value shown on the main display. The response rate for the ACV function frequency measurements can be set in the MONITOR CONFIG menu. When Fast is not selected, the frequency measurements are made with a 1 s response rate at a 6.5-digit resolution, otherwise all frequency measurements are made with a 50 ms response rate at a 4.5-digit resolution. The 1 s response rate will slow down the ACV reading rate.

Displaying Standard Deviation

Press the Devn key to calculate and display the population standard deviation of a block of readings.

The population standard deviation is calculated as
$$\sqrt{\frac{\sum_1^n (x - \bar{x})^2}{n - 1}}$$

For the standard deviation of a rolling block of readings the AvR rolling average mode must be configured and selected from the MATH menus.

For the standard deviation of a fixed block of readings the BlocN block average mode must be configured and selected from the MATH menus.

Devn Menu

```
Display STD Deviation in:  FFM  Ab
```

Standard Deviation Menu

adj146f.eps

This menu allows selection of the displayed format for the standard deviation.

- FFM Displays the standard deviation of the block relative to the block mean.
- Abs Displays the standard deviation of the block as an absolute value.

```
STD DEVIATION = xxxxxxxx
```

Standard Deviation display

adj147f.eps

Displaying Maximum, Minimum, and Peak-to-Peak Readings

The MAX, MIN, and PKPK menus have the same format and show information derived from measurements taken since the Min, Max, or Pkpk mode was reset.

Once one of the three menus has been entered, you can select either of the other two without going through the MONITOR menu.

MAX or MIN can be cleared by its own Reset soft key, but the Reset soft-key on the PKPK menu clears both the Max and Min memory.

In DCV and DCI, the MAX value is the most positive (or least negative) measurement and the MIN value is the most negative (or least positive) measurement.

Note

Because Pkpk does not store a value except as a result of calculating the difference between a maximum and a minimum value, if the MAX or MIN memory is cleared, the PKPK menu value is also cleared until the first measurement enters the cleared memory. After this, the PKPK menu value reflects the change by showing the new difference between the maximum and minimum values.

The Multimeter does not clear the MAX or MIN values upon a change of function, range, or other measurement parameter. These can be cleared only by pressing the appropriate Reset key.

MAX Menu

```
MAX =                               Reset Max Min Pkpk
```

MAX menu

adj117f.eps

Limit-Checking

Select the Limit key to display whether high and low limits that were previously set, have been exceeded by the **most recent** measurement.

The display indicates a HI LIMIT if the most recent measurement is above the high limit of a preset range, LO LIMIT if it is below the low limit, or PASS if it is within the limit range.

Limits can be defined from the LIMIT menu, or from MONITOR CONFIG Menu.

```
LIMIT:  PASS                               Hilt Lolt Quit
```

LIMIT menu

adj118f.eps

Hi Lt/Lo Lt The last HI LIMIT/ LO LIMIT value is displayed and the numeric keyboard is activated to allow entry of a new limit. Enter completes the new limit or Quit leaves the value unchanged.

Monitor Menu Tree

An overview of the Monitor mode and a diagram of the Monitor menu tree follows.

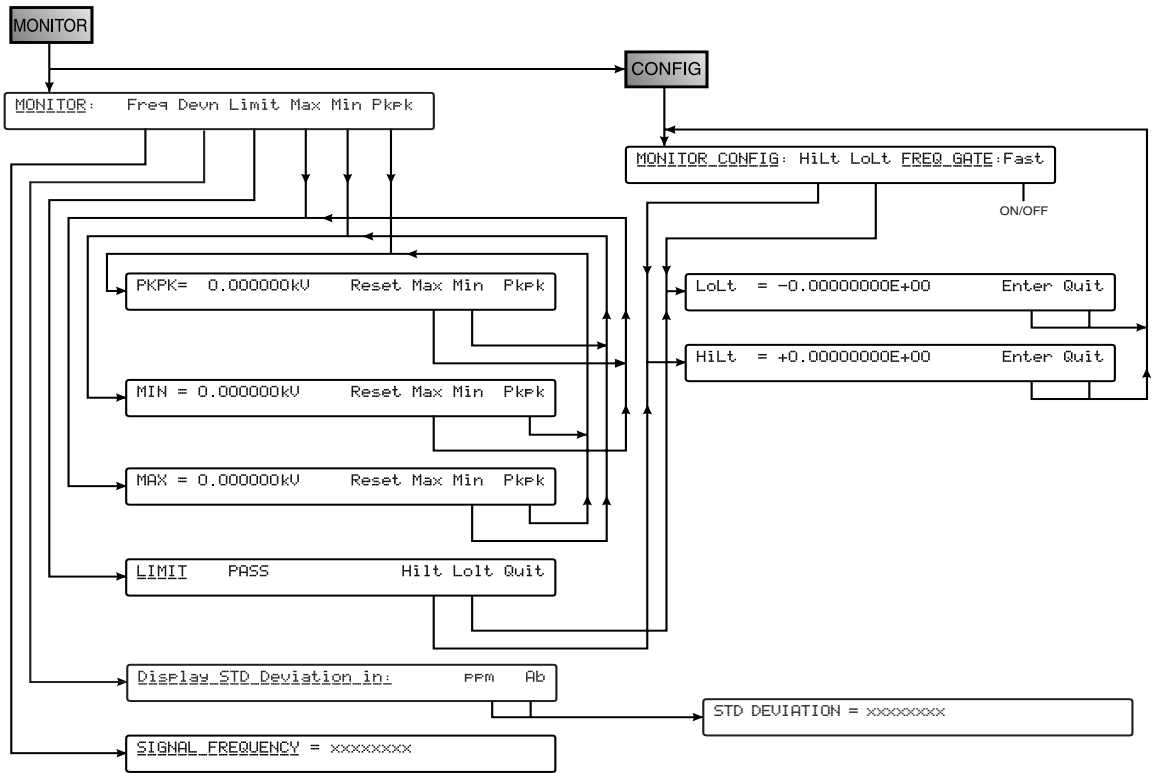

Monitor Menu Tree

adj114f.eps

Note

From any of these menus, pressing the Config hard key will enter the MONITOR CONFIG menu; pressing the Monitor key reverts to the MONITOR menu.

Utility

Press the Utility key to see the UTILITY menu:

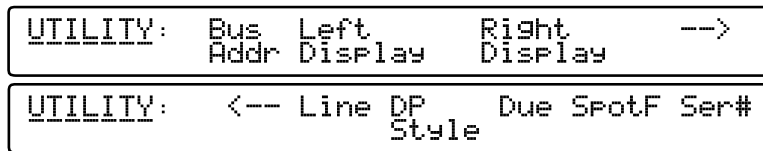

Utility Menu

adj119f.eps

This menu has the following menu key selections:

Bus Addr Displays the ADDRESS menu to view and change the IEEE-488 bus address of the Multimeter.

Left Dis Provides a contrast menu for adjustment to the left hand or main display.
Play

- Right Display** Provides a contrast menu for adjustment to the right hand display.
- Line** Provides selection of the power line frequency for the Multimeter.
- SpotF** When in ACV function this softkey displays the SPOTF menu to view the spot frequencies at which the Multimeter has been calibrated.
- Ser#** Displays the SER# menu, to view the serial number of the Multimeter and version of the software in it.
- Due** Displays the CAL DUE date. This shows the user-entered recommended date for recalibration of the instrument.
- Display Style** Provides selection for display styles for the measurements.

IEEE 488 ADDRESS

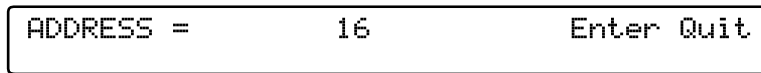

IEEE Bus address key Menu

adj120f.eps

The menu displays the present address value, and the numeric-keyboard keys are activated. Any valid numeric value (0-30) may be entered.

LINE Frequency

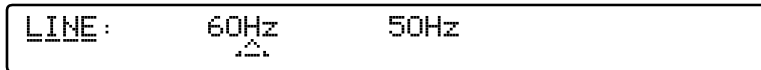

Line Frequency

adj121f.eps

This selection adjusts the integration time of the Analogue to Digital convertor to align with an integral number of power line cycles at 50 Hz or 60 Hz. Correct setting is critical to the Normal Mode and Common Mode rejection of the instrument. Once set, the LINE frequency is retained even after the Multimeter is turned OFF.

SPOTF Menu

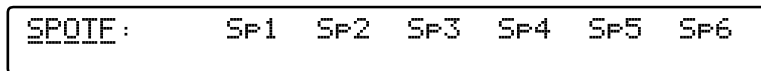

SPOTF Menu

adj122f.eps

This display is for information only. The Spot Frequencies cannot be altered except via Calibration at new values.

The SPOTF menu has six soft keys (Sp1 through Sp6), each allows the user to view one of the six possible spot frequencies that could have been calibrated for the currently active ACV range.

SER# Display



adj123f.eps

Ser# display

This display is for information only. The serial number cannot be altered except in one of the calibration menus at the factory.

The software issue number (last four digits) is embedded in the software itself, and is not user-alterable.

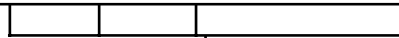
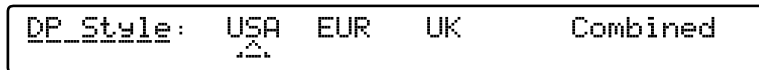

TOGGLE

DP Style Menu

adj144f.eps

The DP style allows the selection of the display format for the readings.

USA	+10.000104 _u
EUR	+10,000104 _u
UK	+10·000104 _u
Combined	+10·000,104 _u

adj387f.eps

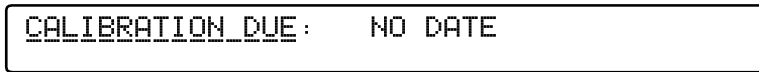

adj145f.eps

Calibration Due Menu

Calibration Due: this displays the date optionally entered during the exit from the most recent calibration.

Status Reporting - Movement between Menus

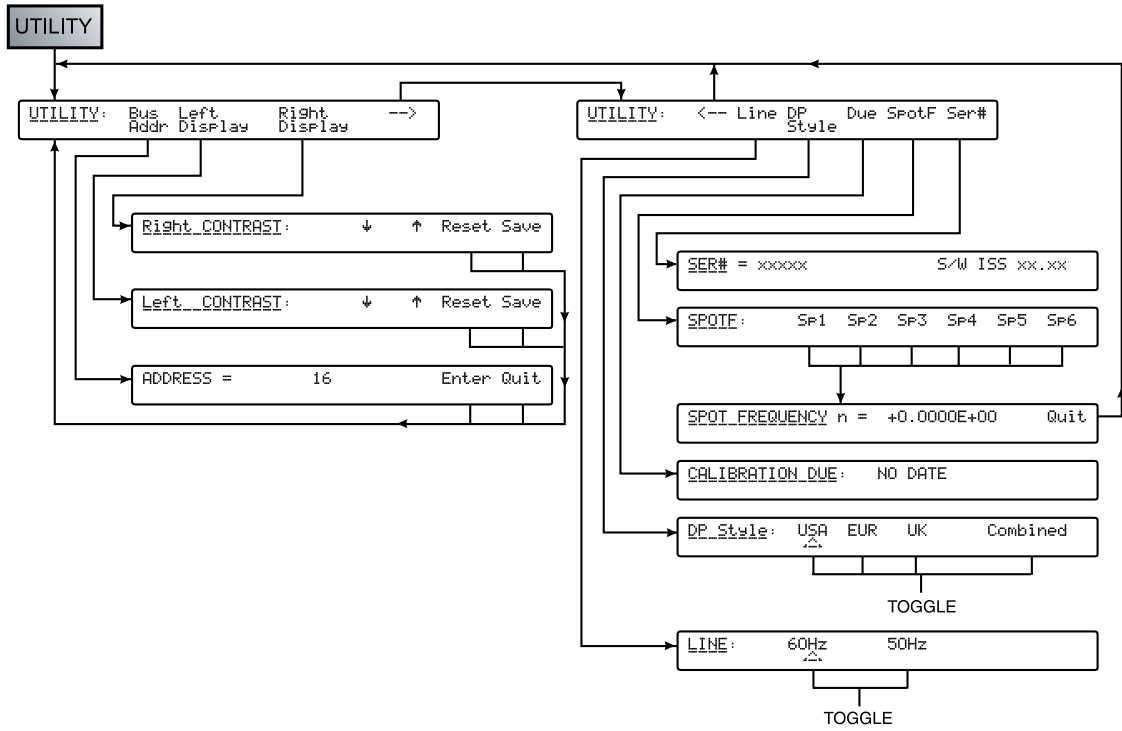

adj124.eps

Status Reporting -- Movement Between Menus

Using the Selftest Functions

This section covers the Multimeter's selftest functions that can be performed via the Test key. An overview of the Test mode and a diagram of the Test menu tree is provided in the following figure.

Test Menu Tree

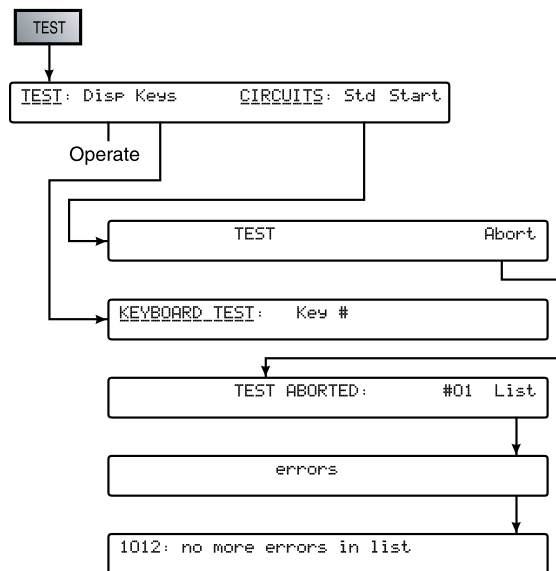

adj125.eps

Test Menu Tree

Test Key

Press the Test key to display the TEST menu, from which you can choose to perform a variety of selftests.



TEST: Disp Keys CIRCUITS: Std Start

adj126f.eps

TEST Menu

The TEST menu allows you to initiate front panel display and key tests and 'Circuit' test. The latter has either a standard single sequence of test or the capability to loop this sequence of tests.

Please note that the instrument should be allowed a warm up period of 10 minutes before performing an internal self test and that ambient temperature should be between 15 °C and 35 °C.

Disp Press any key **other** than Test to step both displays through a sequence of 'walking strobes', which allow you to inspect segments and complete blocks.

Press Test during the Disp checks to terminate the display test.

Keys Press Keys to test all keys other than Test. The key's hexadecimal matrix position appears to the left of a colon; to the right of the colon an S is followed by the key's switch number, and the name of the key is given on the right of the display.

Press Test during the Key checks to terminate the key test.

Start Press to start a selftest and disable all other function keys, signal inputs and normal trigger sources.

While selftest is running the display shows a reference number of the test currently being performed.

A fail indicator (?) may be added to the display, and this will persist to the end of the test sequence. Press the Abort key to stop the test. In the TEST ABORT and TEST UNSUCCESSFUL menus, repeatedly pressing the List key reads out the failures in turn. The memory of each failure is lost as it is read.

Appendix A contains a list of the failure-message numbers.

Note

The success of Selftest can be inhibited by:

Temperature not in the range: 5 °C to 40 °C, and presence of excessive RFI or Line noise.

Using the Math Functions

Math Functions and Menu Tree

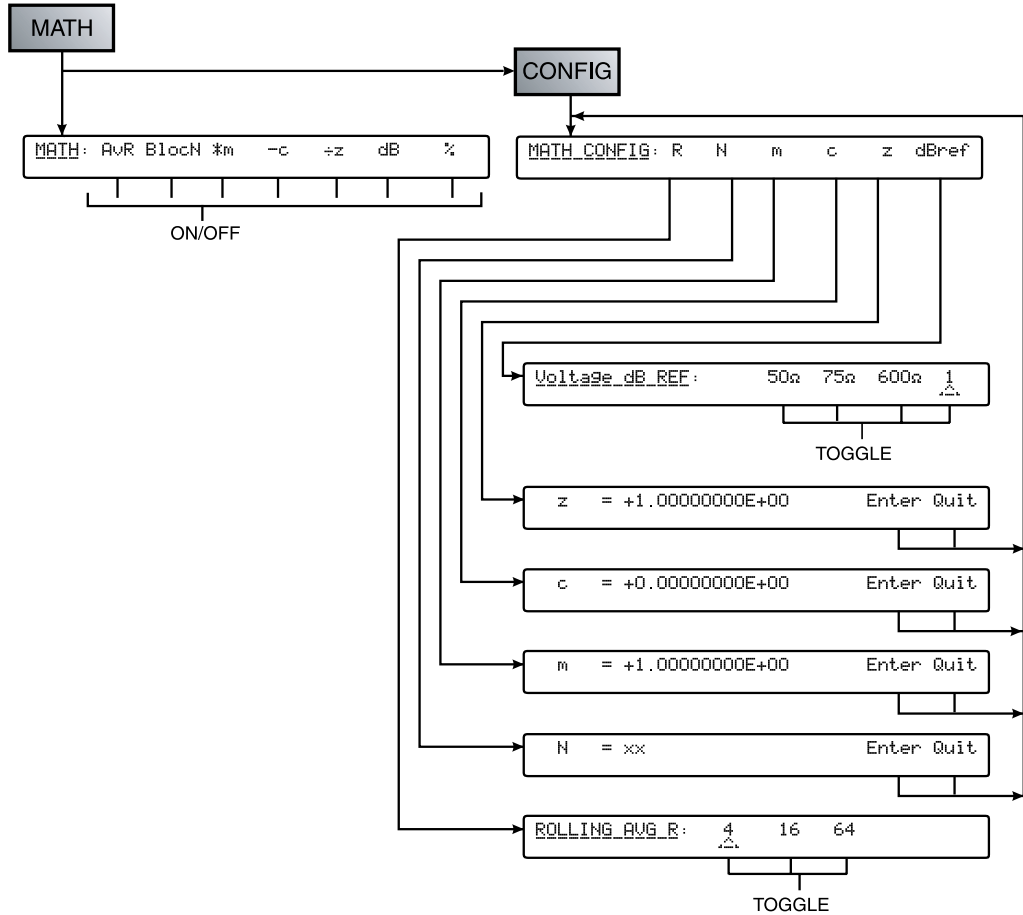

Math Menu Tree

adj127f.eps

Press the Math key to display the MATH menu. The MATH menu provides selections for a variety of linear, averaging, and logarithmic calculations.

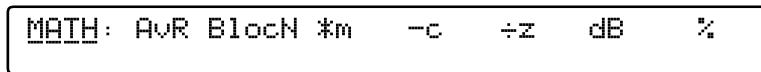

MATH Menu

adj129f.eps

Mathematical operations are performed on the readings obtained from the main measurement function in strict left-to-right order. All operations are independently selectable. The activation of any math operation displays the 'MATH' legend on the main (left-hand) display and the measurement units e.g. V will not be displayed except when the only math operation is '-C'. An exponent is added to the numeric value displayed to scale the mathematical results.

All constants (except %) used in the mathematical operations are set in the MATH CONFIG menu.

Note

From any of the menus below, pressing the Config key enters the MATH CONFIG menu; pressing the Math key reverts to the MATH menu.

Press Enter or Quit to revert automatically to the MATH CONFIG menu.

- AvR Causes a rolling average of **R** readings to be made. AvR cross-cancels with BlocN.
- BlocN Causes a block average of **N** readings to be made. BlocN cross-cancels with AvR.
- $\times m$ Causes the measurement to be multiplied by a constant, **m**.
- $- c$ Causes a constant, **c**, to be subtracted from the measurement.
- $\div z$ Causes the measurement to be divided by the constant, **z**.
- dB Causes the measurement to be expressed in dB relative to **1**, or to **z**, or to **dBref**.
Constants **dBref** and **z** are defined via the MATH CONFIG menu.
- $\times 100$ Causes the measurement to be multiplied by **100**.

Math Configuration

Press the Config key from the MATH menu to display the MATH CONFIG menu, from which you can store the various constants used by the Math operations.

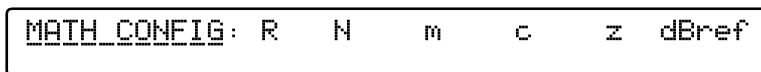

adj130f.eps

MATH CONFIG menu

The MATH CONFIG menu has six menu keys.

- R** Provides selection of the number of readings used in rolling average.
- N** Provides a numeric entry menu for the value of N. The most recent N value is shown and the keyboard is activated. Press Enter to store the new value or Quit to leave the old value intact and return to the MATH CONFIG menu.
- m** Provides a numeric entry menu for the value of the multiplier constant, **m**.
- c** Provides a numeric entry menu for the value of the subtractor constant, **c**.
- z** Provides a numeric entry menu for the value of the divisor constant, **z**.
- dBref** Provides selection of the decibel reference constant, **dBREF** Only voltage functions can utilize all the settings. Other functions will utilize a unity reference.
 - 50Ω Selects a reference of 1 mW in 50 Ω.
 - 75Ω Selects a reference of 1 mW in 75 Ω.
 - 600Ω Selects a reference of 1 mW in 600 Ω
 - 1** Selects a unity reference value.

Clear Functions



adj143f.eps

CLEAR Menu

The 'input zero' corrections will remain active until power down, but the selections available in this menu will allow the corrections to be cleared.

- | | |
|-------------|--|
| Rng Zero | Removes the correction for the currently selected range and function. |
| Func Zero | Removes the correction for all ranges for the currently selected function. |
| Pwr up Dflt | Sets the instrument to the conditions which exist at power up. |

Chapter 4

Remote Operations Using the IEEE 488 Interface

Title	Page
Introduction.....	4-3
Interface Capability: IEEE Standards 488.1 and 488.2	4-3
The Multimeter in IEEE 488.2 Terminology	4-3
Programming Options	4-3
Capability Codes	4-3
Interconnections.....	4-4
Using the 8508A Reference Multimeter in a System	4-5
Setting the Multimeter Address.....	4-5
Remote Operation General Considerations	4-5
Syntax Diagrams in this Manual	4-5
The 8508A Status Reporting Structure.....	4-8
Types of Status Information Available.....	4-9
Syntax Diagrams of Major 8508A Functions	4-10
DC Voltage.....	4-10
AC Voltage.....	4-11
Resistance: Normal OHMS	4-13
Resistance: High Voltage OHMS.....	4-14
Resistance: True OHMS.....	4-15
DC Current	4-16
AC Current	4-17
Using Platinum Resistance Thermometers to obtain Temperature.	4-18
Determine the PRT identity.....	4-18
Entering or Editing the Characteristics of a PRT to Non-volatile Store.....	4-19
Recalling the Characteristics of a Known PRT	4-20
Deleting a Known PRT from the Non-volatile Store	4-20
Input.....	4-21
Guard	4-21
Measurement Gate Width.....	4-22
Maximum, Minimum and Peak-Peak	4-22
Limits.....	4-24
Recall Limits	4-24
Enable Limits.....	4-24
Standard Deviation	4-25
Syntax Diagrams of Math Functions	4-25
Averaging	4-25
Multiplication	4-27

Subtraction.....	4-28
Division	4-29
Decibel Calculations.....	4-30
Syntax Diagram of Test	4-31
Selftest	4-31
Device Errors and Syntax Diagrams.....	4-31
Error Detection	4-31
Recall Device Errors.....	4-32
Triggering and Reading Operations.....	4-33
Trigger Source Selector.....	4-33
Execute Trigger	4-34
Execute Trigger and Take a Reading	4-34
Settling Delay	4-34
Input Zero	4-36
Wait	4-36
Reading Recall.....	4-36
Access to the Internal Buffer Memory	4-37
Internal Operations Commands	4-39
Reset	4-39
Complete Operations	4-40
Status Reporting.....	4-40
Instrument I/D and Setup.....	4-44
Calibration Commands and Messages.....	4-46
Calibration Sequences	4-46
Protected User Data.....	4-48
Special Calibrations.....	4-49

Introduction

Chapter 4 provides the information necessary to operate the 8508A Reference Multimeter remotely via the IEEE 488 Interface. (Hereafter, the 8508A is also referred to as "the Multimeter" or, in the context of IEEE 488.2 terminology, "the device")

For users unfamiliar with the IEEE 488 Interface, refer to the standard specification, which appears in the publications ANSI/IEEE Std. 488.1-1987 and IEEE Std. 488.2-1988.

A complete description of all commands and queries, along with syntax diagrams, is provided under "Command, Queries, and Syntax Diagrams" later in this chapter.

The material in this chapter is organized in the following categories:

- **Interface Capability**
Introduction to the IEEE 488.1 subsets that are implemented in the Fluke 8508A, satisfying IEEE 488.2.
- **Interconnections**
Description of the rear panel IEEE 488 connector and its pin designations.
- **Using the Multimeter in a System**
Addressing, remote operation, programming guidance.
- **Syntax Diagrams in this Manual**
An introduction to syntax diagrams
- **The 8508A Status Reporting Structure**
- **Programming Commands and Queries**
Detailed descriptions of both common and device-specific commands and queries, including syntax diagrams.

Interface Capability: IEEE Standards 488.1 and 488.2

The Fluke 8508A Reference Multimeter conforms to the Standard Specification IEEE 488.1-1987: *IEEE Standard Digital Interface for Programmable Instrumentation*, and to IEEE 488.2-1988: *Codes, Formats, Protocols and Common Commands*.

The Multimeter in IEEE 488.2 Terminology

In IEEE 488.2 terminology, the Multimeter is a **device** containing a **system interface**.

As such, it can be connected to a **system** via its **system bus** and put into programmed communication with other bus-connected **devices** under the direction of a **system controller**.

Programming Options

The Multimeter can be programmed via the IEEE Interface to do the following:

- Change its operating state (e.g., function, range etc).
- Transmit measurements and its own status data over the bus.
- Request service from the system controller.

Capability Codes

The codes that apply to the 8508A Reference Multimeter and a short description of each are given in Table 4-1. They also appear on the rear of the instrument next to the interface connector. These codes conform to the capabilities required by IEEE 488.2. Appendix C of the IEEE 488.1 standard contains a complete description of each code.

Table 4-1. IEEE Interface Capability

IEEE 488.1 Subset	Interface Function
SH1	Source Handshake Capability
AH1	Acceptor Handshake Capability
T6	Talker (basic talker, serial poll, unaddressed to talk if addressed to listen)
L4	Listener (basic listener, unaddressed to listen if addressed to talk)
SR1	Service Request Capability
RL1	Remote/Local Capability (including Local Lockout)
PP0	No Parallel Poll Capability
DC1	Device Clear Capability
DT1	Device Trigger Capability
C0	No Controller Capability
E2	Open-Collector and Three-State Drivers

Interconnections

Instruments fitted with an IEEE 488 interface communicate with each other through a standard set of interconnecting cables, as specified in the IEEE 488.1 Standard document.

The interface socket is fitted on the rear panel. It accommodates the specified connector, whose pin designations are also standardized as shown in Figure 4-1.

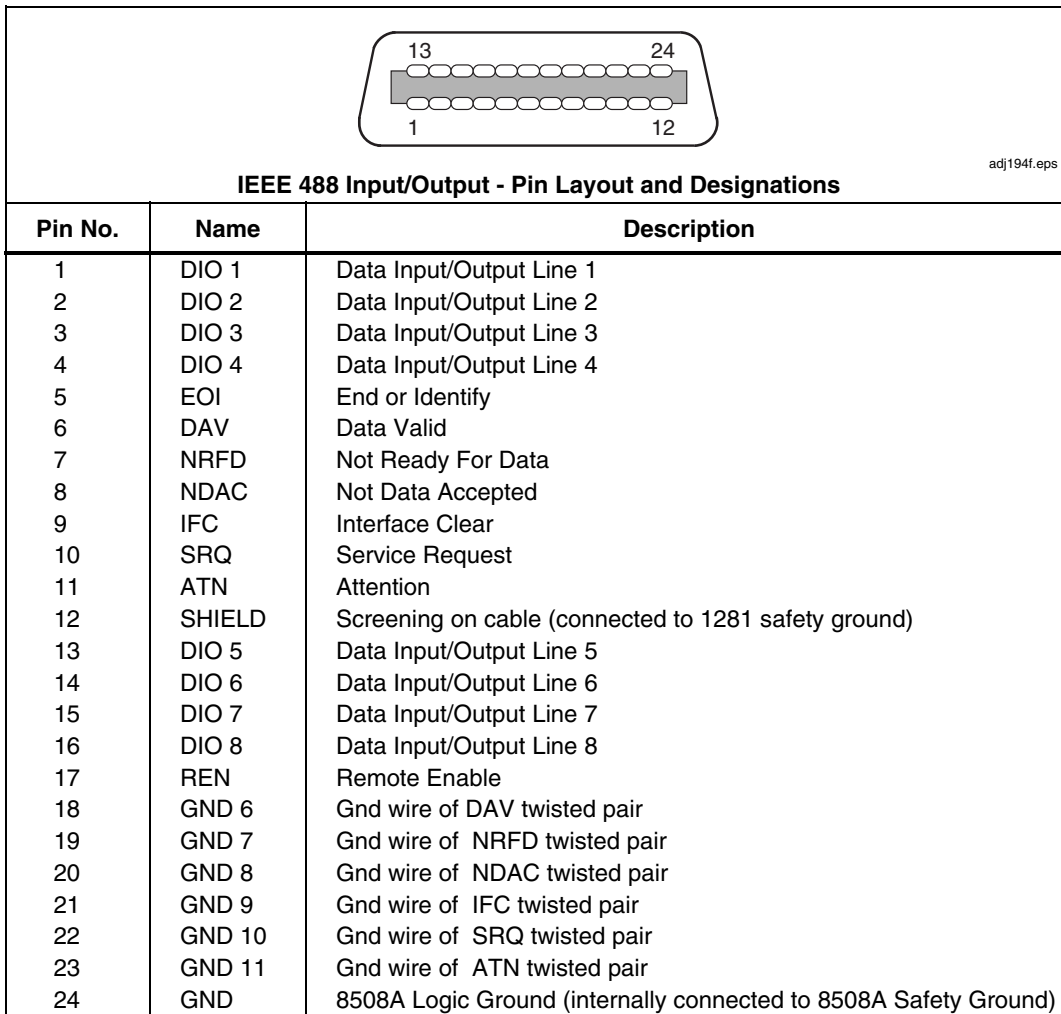

Figure 4-1. IEEE 488 Input/Output Connector

Using the 8508A Reference Multimeter in a System

Setting the Multimeter Address

The Multimeter will only respond to Talk or Listen commands from the controller at a specified address. The Multimeter address can only be set manually; using the ADDRESS menu that is accessed via the Utility menu.

To change the address, proceed as follows:

1. Press the UTILITY key to see the menu:

```
UTILITY:  Bus  Left  Right  -->
           Addr Display Display
```

```
UTILITY:  <-- Line DP  Due SpotF Ser#
           Style
```

adj119f.eps

UTILITY menu

2. Press Bus Addr to display the ADDRESS menu from which you can enter or change the Multimeter's IEEE-488 bus address.

```
ADDRESS =      16      Enter Quit
```

adj120f.eps

ADDRESS menu

The menu displays the present address and the numeric-keyboard keys are activated.

3. Enter any valid numeric value between 0 and 30. If you enter an invalid address, 1007: data entry error is displayed.
4. Press Enter to store the new address OR press Quit to leave the old address unchanged.

Remote Operation General Considerations

When the 8508A Reference Multimeter is operating under the direction of the controller, the right hand display indicates Remote Operation together with the function and range settings. The front panel controls are disabled with the exception of LOCAL (provided *Local Lockout* has not been programmed).

Syntax Diagrams in this Manual

The following paragraphs describe the syntax diagrams used in this manual.

- Syntactic elements are connected by lines with directional symbols to indicate the flow, which generally proceeds from left to right.
- Repeatable elements have a right-to-left reverse path shown around them, which will also contain a separator such as a comma.
- When it is possible to bypass elements, a left-to-right path is shown around them.
- When there is a choice of elements, the path branches to the choices.

The Program Message

Each Program Message may consist of only one syntactic element plus its terminator, or may be subdivided into many "Program Message Units", separated by semi-colons (;)

which are known as "Program Message Unit Separators". Thus the semi-colon cannot be used for any other purpose.

As you can see from the diagram, multiple Program Message Units can be sent if they are separated using semi-colons (shown in the repeat path). The starting circle is used only for the diagram to indicate the start of a complete Program Message.

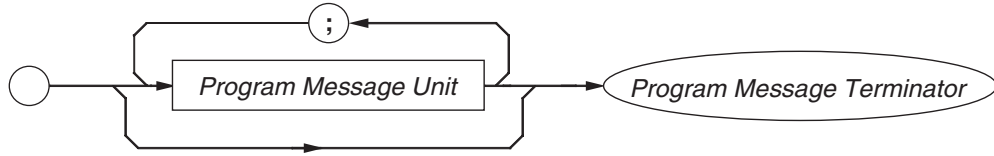

Syntax Diagram of a Simple Program Message

adj199f.eps

Use of Italics

Notice that the names of some elements are shown here in italics which indicate "non-literal" text (i.e., names given to particular elements) The actual characters to be sent, are shown in plain-text capitals.

Upper/Lower Case Equivalence

The Multimeter will not differentiate between upper and lower case characters in literal program text.

Numeric Representation

The Multimeter accepts a "Flexible Numeric Representation" (*Nrf*), when receiving numbers.

Decimal numeric responses from the Multimeter are in either Nr1 or Nr3 format. In this manual, all syntax diagrams for query contain the response format.

The Program Message Terminator

The message terminator for the 8508A Reference Multimeter is the hexadecimal number 0A , characterized in IEEE 488.2 as **NL**. Alternatively, the **EOI** (end or identify) line can be set true with the last byte to be sent. This is represented on the syntax diagram by /[^]END/.

The Program Message Unit

Program Message Units (PMUs) can be "Terminal" or "Non-terminal". The final PMU in any Program Message is always Terminal (includes the terminator), whereas all preceding PMUs within the Program Message are obviously Non-terminal. Most of the commands in this handbook are described in the form of non-terminal message units:

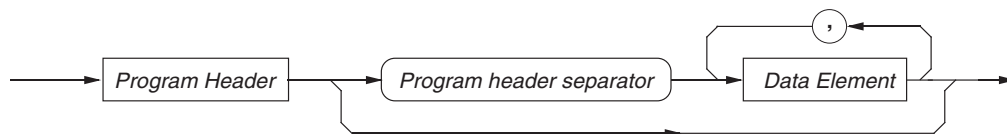

Non-Terminal Program Message Unit

adj352f.eps

To save space, the name 'program header separator' is abbreviated to 'phs'.

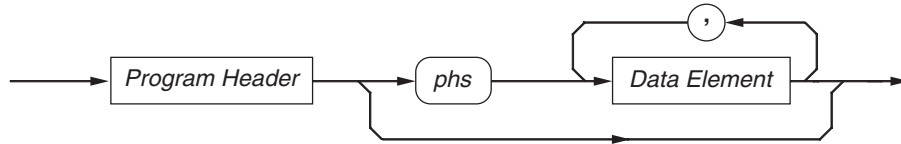

Program Header Separator - phs

adj201f.eps

The Program Header

The 'Program Header' provides the main command identification. This may be followed by 'Program Data Elements' and these must be separated from the 'Program Header' by a 'Program Header Separator'.

The Program Header Separator

The 'Program Header Separator' is one or more 'white space' characters excluding the message terminator (NL).

Program Data Elements

Four versions of the defined program data elements are employed. They are emphasized in the following syntax diagrams, taken from the commands available for the Multimeter:

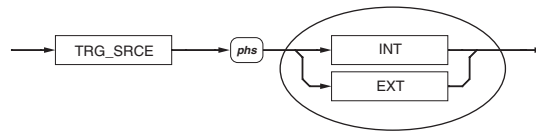

Character

adj203f.eps

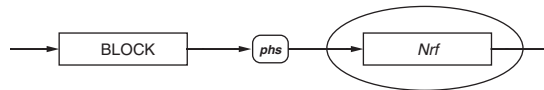

Decimal Numeric

adj204f.eps

(*Nrf* can be expressed in any of the ways defined by the Standard document.)

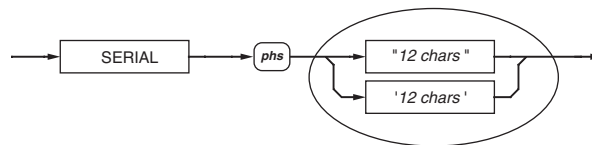

String

adj205f.eps

(The maximum size of the string is specified in the command detail.)

Arbitrary Block Data Elements

Both the "Definite" and "Indefinite" forms specified in the Standard document are used, as shown in the Syntax diagram below. The *user message* must be limited to a maximum of 63 bytes.

The Definite form can be fitted into an assembly of message units, but the Indefinite form (lower path) has no exit to further message units. In this case the program message must be terminated to inform the instrument that the block is complete.

Note that the slash-delimited **/^END/** box is not outlined. This is to draw attention to the fact that it is not a data element, but represents the **EOI** line being set true with the last byte **NL** to terminate the program message.

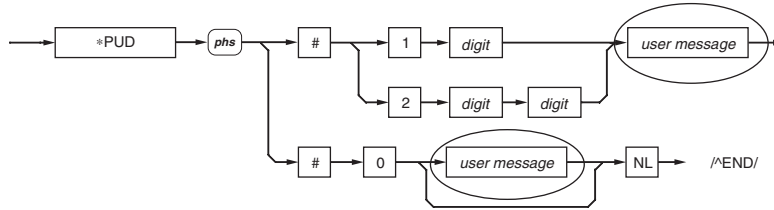

Arbitrary Block Data Element

adj206f.eps

The 8508A Status Reporting Structure

The IEEE 488.2 status reporting structure provides the application programmer with a mechanism to choose the status information required at each stage in the application program.

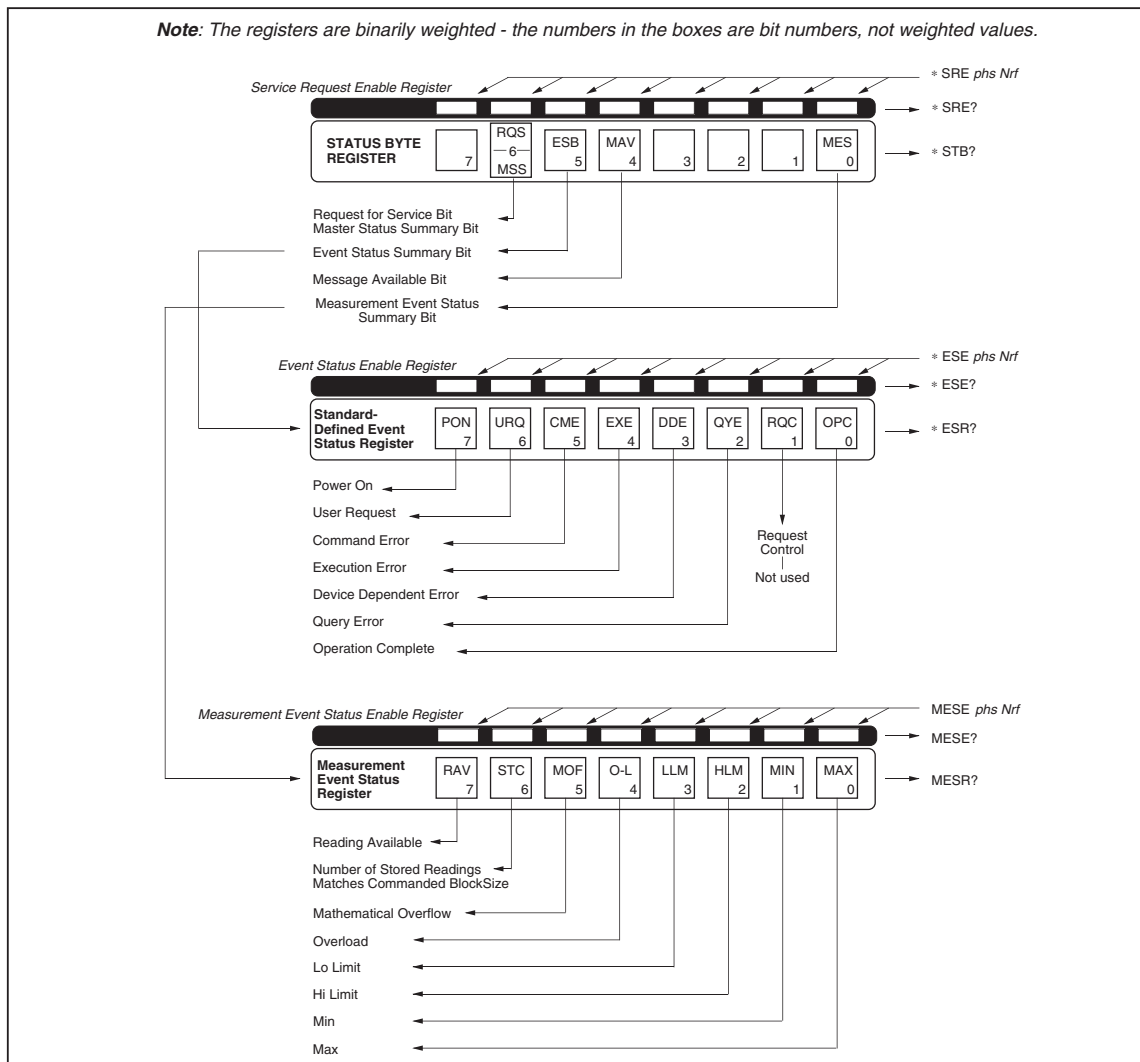

Figure 4-2. 8508A Status Report Structure

adj206f.eps

Standard-Defined and Device-Specific Features

In the 8508A, the structure has three main registers, as follows:

- **The Status Byte Register**, and its associated enable register, control the generation of the **Status Byte**, which summarizes the remainder of the status structure.
- **The Event Status Register**, and its associated enable register, control the generation of the **Event Status Byte**, whose component bits report Standard-defined types of events. This register is summarized by the **ESB** bit 5 in the **Status Byte**.
- **The Measurement Event Status Register**, and its associated enable register, control the generation of the **Measurement Event Status Byte**, whose component bits relate to measurement events in the 8508A. It is summarized by the **MES** bit 0 in the **Status Byte**.

In the **Event Status Byte** the **EXE** bit is associated with a queue of execution errors related to the 8508A programmed condition, and the **DDE** bit is associated with a queue of device-dependent errors related to 8508A internal faults.

A Note about Queues. These are 'historical' (Last-in - Last Out) stacks, and when the queue stack is full the eldest entries are discarded. It is recommended that the application read the queue as soon as its summary bit is set true, particularly the error bits, otherwise the original cause of the error can be discarded as subsequent dependent errors fill up the stack. However any message indicated by the MAV bit should be read before attempting to obtain the ESR status byte.

Access via the Application Program

The application designer has access to three enable registers to enable or disable any individual bit in these registers.

Thus the application programmer can decide which assigned events will generate an **SRQ**, by enabling their event bits and then enabling the appropriate summary bit(s) in the **Status Byte**. The Controller can be programmed to read the **Status Byte** during a resulting serial poll, and be directed to the appropriate **Event Register** to discover which event was responsible for originating the **SRQ**.

Types of Status Information Available

Status Summary Information

The **Status Byte (STB)** consists of flag bits which direct the Controller's attention to the type of event which has occurred.

Standard-defined events

The following events are flagged in the 8-bit latched **Event Status Register (ESR)**, read-accessible to the controller.

- Power On - the instrument's power supply has been switched on.
- User Request - This capability is not available in the 8508A.
- Command Error - a received bus command does not satisfy the syntax rules programmed into the instrument interface's parser, and so is not recognized as a valid command.
- Execution Error - a received command has been successfully parsed, but it cannot be executed owing to the current programmed condition of the instrument.

- Device-Dependent Error - a reportable internal operating fault has been detected.
- Query Error - the controller is following an inappropriate message exchange protocol, in attempting to read data from the output queue.
- Request Control - provided for devices which are able to assume the role of controller. This capability is not available in the 8508A.
- Operation Complete - initiated by a message from the controller, indicates that the 8508A has completed all selected pending operations.

Measurement events

The following events are flagged in another 8-bit latched register, called the **Measurement Event Status Register (MESR)**, read-accessible to the controller.

- A measurement has been completed from an initiating trigger.
- When the instrument has been commanded to store a number of measurements in a block, and the specified number of measurements in the block has been stored.
- Mathematical Overflow
- Overload
- Low Limit Reached
- High Limit Reached
- New Minimum Value Established
- New Maximum Value Established

Syntax Diagrams of Major 8508A Functions

DC Voltage

The following commands are used to select the DCV function and set its configuration.

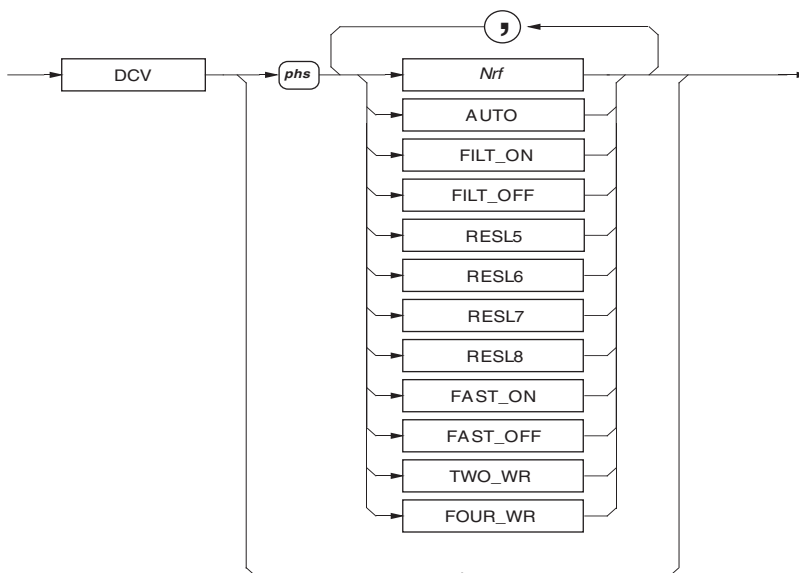

DC Voltage

adj209f.eps

Nrf

A numeric value that selects the range for the expected signal. For example, an **Nrf** of 2, 10, or even 15.6789, selects the 20 V range. Any valid numeric value cancels autorange.

AUTO

Selects the autorange mode where the multimeter will determine the appropriate range for the measured signal.

If the signal exceeds the maximum capability then RANGE OVERLOAD appears on the front panel, and the appropriate bit is set in the device status registers.

FILT_ON / FILT_OFF

FILT_ON inserts a hardware analog filter into the signal path.

RESL5 / RESL6 / RESL7 / RESL8

Sets the resolution of the measurement to 5.5, 6.5, 7.5 or 8.5 digits.

FAST_ON / FAST_OFF

FAST_ON Reduces the A-D integration time, for faster conversions.

TWO_WR

Requires only a connection to the input terminals.

FOUR_WR

Requires a connection to the input terminals and to the sense terminals.

Power On and Reset Conditions

1kV, FILT_OFF, RESL7, FAST_ON, TWO_WR

AC Voltage

The following commands are used to select the ACV function and set its configuration.

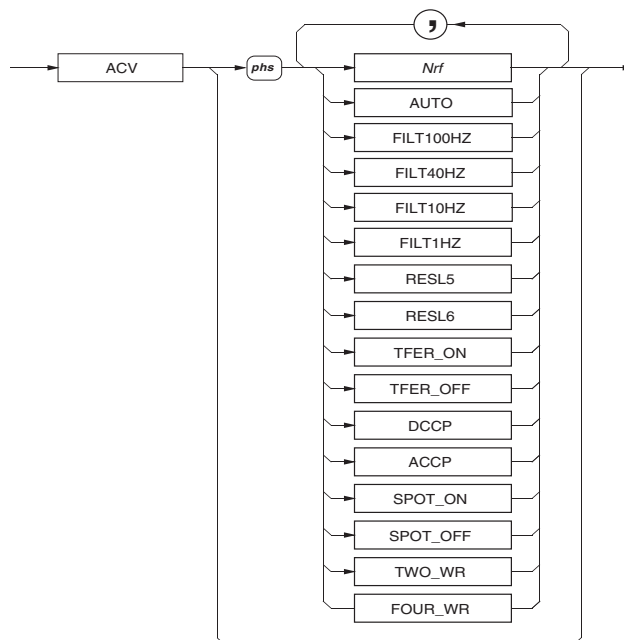

adj210f.eps

AC Voltage

Nrf

A numeric value that selects the range for the expected signal. For example, an **Nrf** of 2, 10, or even 15.6789, selects the 20 V range. Any valid numeric value cancels autorange.

AUTO

Selects the autorange mode where the multimeter will determine the appropriate range for the measured signal. If the signal exceeds the maximum capability then **RANGE OVERLOAD** appears on the front panel and the appropriate bit is set in the device status registers.

FILT100HZ / FILT40HZ / FILT10HZ / FILT1HZ

Selects the chosen analog filter for the RMS converter, thus allowing measurement to be made at frequencies down to the chosen filter frequency. One of the four available filters is always in circuit.

TFER_ON

This selects an internal electronic AC-DC transfer mode for AC measurement which improves linearity and temperature performance.

TFER_OFF

The instrument can take faster readings at some reduction in accuracy.

DCCP

Selects DC-coupled measurements. *Note - DC-coupled should be selected for signal frequencies less than 40 Hz.*

ACCP

Selects AC-coupled measurements.

RESL5 / RESL6

Sets the resolution of the measurement to 5.5 or 6.5 digits.

SPOT_ON / SPOT_OFF

Applies spot frequency corrections (previously calibrated) when the signal frequency is within 10 % of the spot frequencies.

TWO_WR

Requires only a connection to the INPUT terminals.

FOUR_WR

Requires a connection to the INPUT terminals and to the SENSE terminals.

Measurements of RMS Value and Frequency

For each RMS measurement trigger, a parallel measurement of signal frequency is also triggered (4.5 or 6.5 digit frequency resolution depending on gate width selection).

Power On and Reset Conditions

1kV, FILT40HZ, RESL6, TFER_ON, ACCP, SPOT_OFF, TWO_WR

Recall of Spot Frequency Value

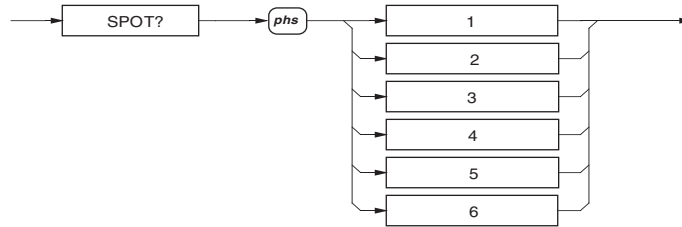

adj211f.eps

Recall of Spot Frequency

(Nr3) Recalls the frequency value for the specified calibrated spot on the active ACV range.

Resistance: Normal OHMS

The following commands are used to select the Normal OHMS function and set its configuration.

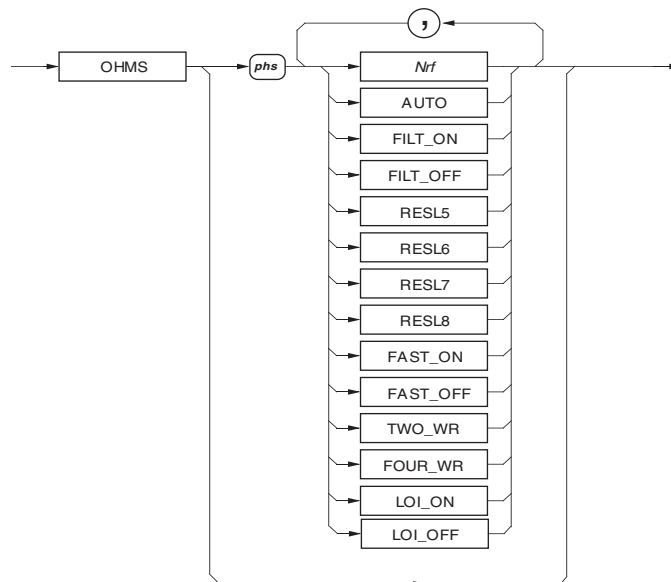

adj212f.eps

Normal OHMS

Nrf

A numeric value that selects the range for the expected signal. Any valid numeric value cancels autorange.

AUTO

Selects the autorange mode where the multimeter will determine the appropriate range for the measured signal. If the signal exceeds the maximum capability then RANGE OVERLOAD appears on the front panel and the appropriate bit is set in the device status registers.

FILT_ON / FILT_OFF

FILT_ON inserts a hardware analog filter into the measurement signal path.

RESL5 / RESL6 / RESL7 / RESL8

Sets the resolution of the measurement to 5.5, 6.5, 7.5, or 8.5, digits.

FAST_ON / FAST_OFF

FAST_ON Reduces the A-D integration time, for faster conversions.

TWO_WR

Selects 2-wire Ohms (Use Hi and Lo terminals). (For backwards compatibility TWR can also be used.)

FOUR_WR

Selects 4-wire Ohms. (For backwards compatibility FWR can also be used.)

LOI_ON / LOI_OFF

Selects low current mode.

Power On and Reset Conditions

20kΩ, FILT_OFF, RESL7, FAST_ON, TWO_WR, LOI_OFF

Resistance: High Voltage OHMS

The following commands are used to select the High Voltage OHMS function and set its configuration.

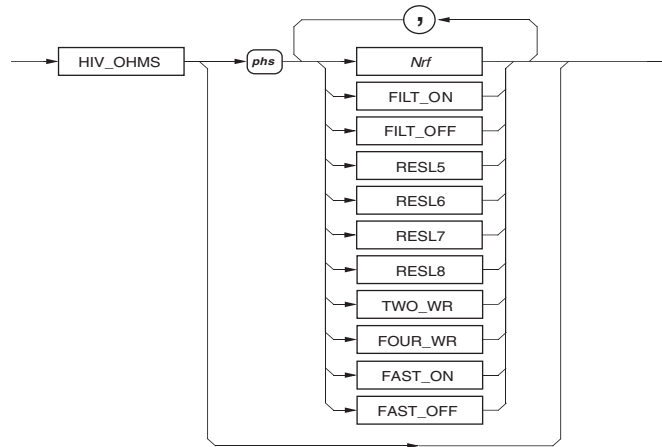

High Voltage OHMS

adj213f.eps

Nrf

A numeric value that selects the range for the expected signal. Any valid numeric value cancels autorange.

FILT_ON / FILT_OFF

FILT_ON inserts a hardware analog filter into the measurement signal path.

RESL5 / RESL6 / RESL7 / RESL8

Sets the resolution of the measurement to 5.5, 6.5, 7.5, or 8.5, digits.

FAST_ON / FAST_OFF

FAST_ON Reduces the A-D integration time, for faster conversions.

TWO_WR

Selects 2-wire Ohms (Use Hi and Lo terminals). (For backwards compatibility TWR can also be used.)

FOUR_WR

Selects 4-wire Ohms. (For backwards compatibility FWR can also be used.)

Power On and Reset Conditions

20MΩ, FILT_OFF, RESL6, FAST_OFF, TWO_WR

Resistance: True OHMS

The following commands are used to select the True OHMS function and set its configuration.

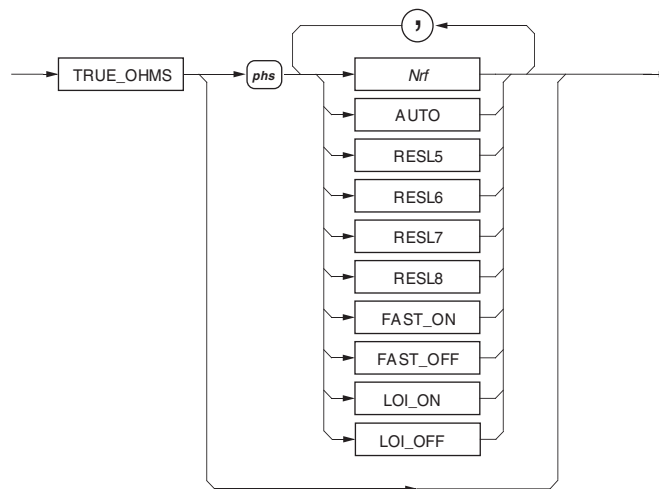

True OHMS

adj214f.eps

Nrf

A numeric value that selects the range for the expected signal. Any valid numeric value cancels autorange.

AUTO

Selects the autorange mode where the multimeter will determine the appropriate range for the measured signal. If the signal exceeds the maximum capability then RANGE OVERLOAD appears on the front panel and the appropriate bit is set in the device status registers.

RESL5 / RESL6 / RESL7 / RESL8

Sets the resolution of the measurement to 5.5, 6.5, 7.5, or 8.5 digits.

FAST_ON / FAST_OFF

FAST_ON Reduces the A-D integration time, for faster conversions.

LOI_ON / LOI_OFF

Selects low current mode.

Power On and Reset Conditions

20kΩ, RESL7, FAST_ON, LOI_OFF

DC Current

The following commands are used to select the DCI function and set its configuration.

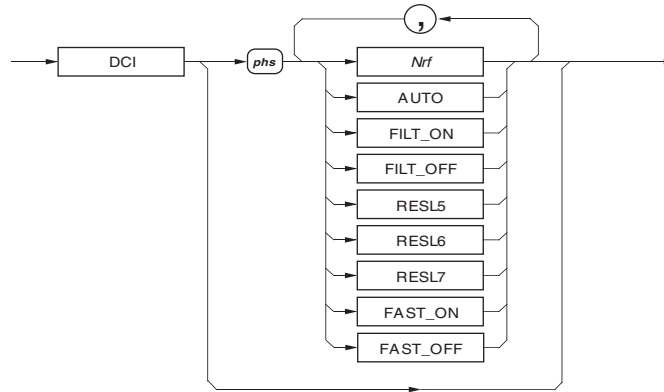

DC Current

adj215f.eps

Nrf

A numeric value that selects the range for the expected signal. Any valid numeric value cancels autorange.

AUTO

Selects the autorange mode where the multimeter will determine the appropriate range for the measured signal. If the signal exceeds the maximum capability then RANGE OVERLOAD appears on the front panel and the appropriate bit is set in the device status registers.

FILT_ON / FILT_OFF

FILT_ON inserts a hardware analog filter into the measurement signal path.

RESL5 / RESL6 / RESL7

Sets the resolution of the measurement to 5.5, 6.5, or 7.5 digits.

FAST_ON / FAST_OFF

FAST_ON Reduces the A-D integration time, for faster conversions.

Power On and Reset Conditions

2A, FILT_OFF, RESL7, FAST_ON

AC Current

The following commands are used to select the ACI function and set its configuration.

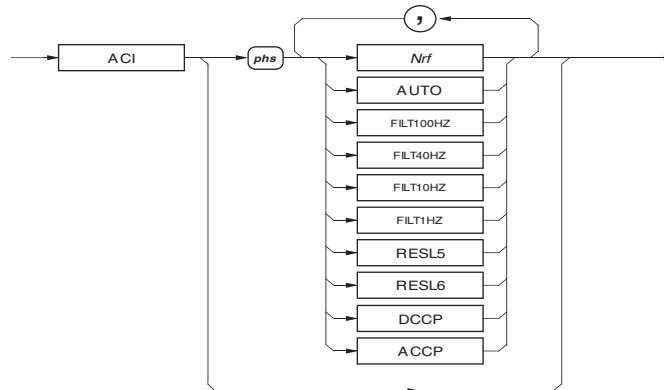

AC Current

adj216f.eps

Nrf

A numeric value that selects the range for the expected signal. Any valid numeric value cancels autorange.

AUTO

Selects the autorange mode where the multimeter will determine the appropriate range for the measured signal. If the signal exceeds the maximum capability then RANGE OVERLOAD appears on the front panel and the appropriate bit is set in the device status registers.

FILT100HZ / FILT40HZ / FILT10HZ / FILT1HZ

Selects the chosen analog filter for the RMS converter, thus allowing measurement to be made at frequencies down to the chosen filter frequency. One of the four available filters is always in circuit.

RESL5 / RESL6

Sets the resolution of the measurement to 5.5 or 6.5 digits.

DCCP

Selects DC-coupled measurements. *Note - DC-coupled should be selected for signal frequencies less than 40 Hz.*

ACCP

Selects AC-coupled measurements.

Measurements of RMS Value and Frequency

For each RMS measurement trigger, a parallel measurement of signal frequency is also triggered (4.5 or 6.5 digit frequency resolution depending on gate width selection).

Power On and Reset Conditions

2A, FILT40HZ, RESL6, ACCP

Using Platinum Resistance Thermometers to obtain Temperature.

The following commands are used to select the PRT function and set its configuration.

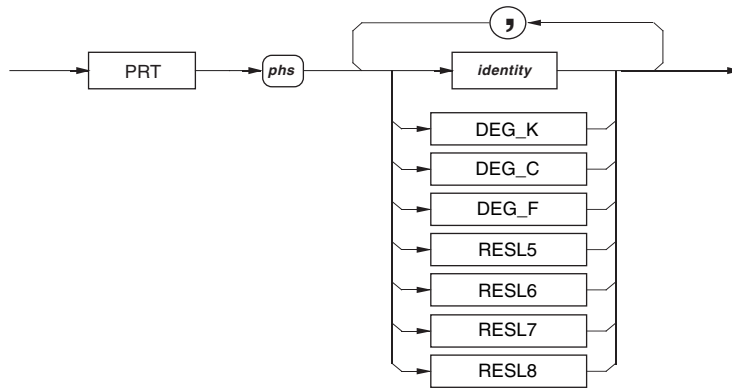

Platinum Resistance Thermometers

adj356f.eps

Identity

This is a string value and thus must be enclosed in *double quotes* and must be identical in all respects with the identity of an already entered PRT. This command will set the selected PRT as the active measurement probe.

DEG_K / DEG_C / DEG_F

This selects the format for presentation of the temperature.

RESL5 / RESL6 / RESL7 / RESL8

Sets the resolution of the measurement and the temperature display to 5.5, 6.5, 7.5 or 8.5 digits.

Execution Errors

If the identity does not match one of the stored PRT identities the error 1026 is generated.

Power On and Reset Conditions

The active probe identity if available, DEG_C, RESL6

Determine the PRT identity.



PRT Identity

adj353f.eps

Response:

(string) Active Probe, (string) next inactive probe

There is always the one identity returned as a string, but the second identity is obtained from an incremental search of the available identities. If no other identities exist then the second string with the separating comma is not appended.

This command can be used to increment through the list of PRT's stored. The user should check for a second appearance of the inactive identity to determine when all possible identities have been viewed.

Entering or Editing the Characteristics of a PRT to Non-volatile Store

The following commands are used to construct a **PRT** identity and set associated parameters and coefficients.

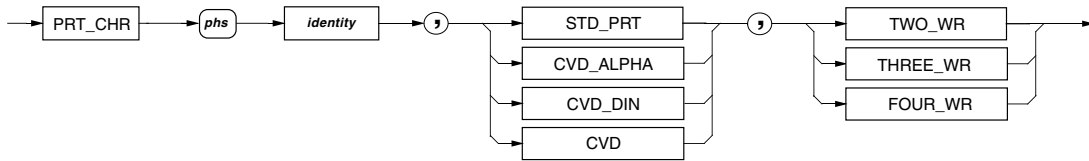

adj357f.eps

Entering or editing PRT characteristics

This command with its associated parameter can be used to enter characteristics of a new PRT identity to the non-volatile store.

Identity

This is a string value and thus must be enclosed in *double*, limited to 17 characters.

STD_PRT

This selects the conversion algorithm to be used. The ITS90 conversion is used for a standard PRT.

CVD_ALPHA

This selects the conversion algorithm (Callender Van Deusen) to be used and the method for expressing the conversion coefficients (R_{zero} α β δ).

CVD_DIN

This selects the conversion algorithm to be used and the method for expressing the conversion coefficients (R_{zero} A B C).

CVD

This selects the conversion algorithm to be used and requires only the R_{zero} value. The other parameters are set to a default value.

TWO_WR / THREE_WR / FOUR_WR

This specifies the type of connection and thus the measurement method.



adj358f.eps

Entering or Editing PRT Coefficients

This command with its associated parameter is used to enter the coefficients, or to edit the existing coefficients of a PRT with a known identity. *NOTE that when editing all the parameters MUST be given in the correct order.* The numbers entered are associated in the following manner:

- For CVD only one number is required for the R_{zero} value.
- For CVD_DIN the first number is the R_{zero} value, the second is the A coefficient, the third the B coefficient and the fourth is the C coefficient.
- For CVD_ALPHA the first number is the R_{zero} value, the second is the α coefficient, the third the β coefficient and the fourth is the δ coefficient.
- For STD_PRT the first number is the resistance of the probe at the triple point of water. The second is the a+ value (a_7). The third is the b+ value (b_7). The fourth is the c+ value (c_7). The fifth is the a- value (a_4). The sixth is the b- value (b_4).

Execution Errors

If the identity is unknown an error is generated for the coefficient entry.

An error is generated if any of the coefficients exceed the limits for correct algorithm operation.

Recalling the Characteristics of a Known PRT

PRT_DATA?



adj355f.eps

Recalling PRT data

Recalls the characterization data and associated coefficients for the probe identity given.

Response Format:

This is a variable length response consisting of comma separated elements :

(string) Identity , algorithm , connection , (Nr3) R_{tp} or R_{zero} , (Nr3) coefficient1 , (Nr3) coefficient2 , (Nr3) coefficient3 , (Nr3) coefficient4 , (Nr3) coefficient5

The 'Identity' consists of 17 ASCII characters enclosed with quotes.

The 'algorithm' will be one of the following: **STD_PRT** or **CVD_ALPHA** or **CVD_DIN** or **CVD**.

The 'connection' will be one of the following: **TWO_WR** or **THREE_WR** or **FOUR_WR**.

The first numeric value will be the resistance of the PRT at either the triple point of water (STD_PRT) or zero degrees C (all CVD).

The number of coefficients appended to this response detailed above is dependant on the algorithm used:

- For CVD there will be no further coefficients.
- For CVD_DIN and CVD_ALPHA there are three comma separated numbers.
- For STD_PRT there are five comma separated numbers.

Deleting a Known PRT from the Non-volatile Store

PRT_DEL



adj354f.eps

Deleting a known PRT

Removes the probe from the store of probe data for the identity given.

Input

The following commands are used to select an input; or combined usage of the two inputs to calculate the Ratio, Difference and Deviation measurement modes. The selections are mutually exclusive.

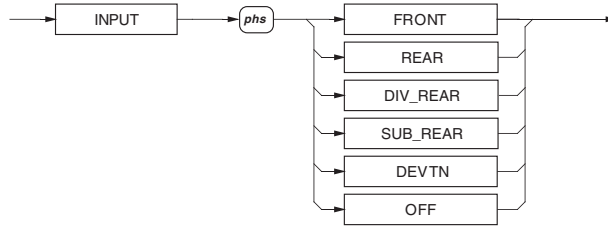

adj217f.eps

Input and Ratio Configurations

FRONT

This selects the front terminals.

REAR

This selects the rear terminals. *NOTE – the DCI/ACI signals that can be applied to the rear terminals are restricted to 2A max. and scan operations for these function are not available. Also 4 wire sense for voltage is not available.*

OFF

This isolates all the terminals and deselects the scanning measurements.

DIV_REAR

This selects the measurement at the front terminals followed by a measurement at the rear terminals and computes the ratio of the signals (Front / Rear).

SUB_REAR

This selects the measurement at the front terminals followed by a measurement at the rear terminals and computes the difference of the signals (Front - Rear).

DEVTN

This selects the measurement at the front terminals followed by a measurement at the rear terminals and computes the deviation of the signals (Front – Rear / Rear).

Power On and Reset Conditions

FRONT

Exit from a Scanning Mode

Achieved by selecting one of the two inputs or OFF.

Guard

Selection of guarding for all functions.

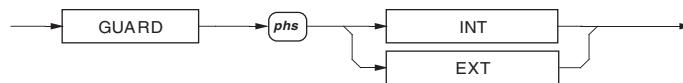

adj218f.eps

Remote Guard

INT / EXT

This selects the connection of the multimeter's guarding. (For backwards compatibility LCL & REM can also be used.)

For scan operations, the guard selection is applied to the channel currently being applied to the A-D converter.

Power On and Reset Conditions

INT (internal)

Measurement Gate Width

This command selects the gate width for frequency readings during AC measurements.

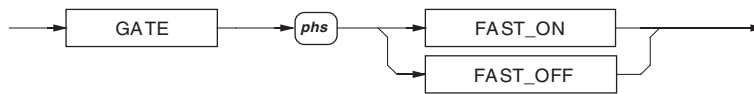

Measurement Gate Width

adj220f.eps

FAST_ON

Selects a gate width of 50ms, and a frequency resolution of 4.5 digits.

FAST_OFF

Selects a gate width of 1s, and a frequency resolution of 6.5 digits.

Both selections are mutually exclusive.

The use of the longer gate width results in a 6.5 digit frequency measurement. The frequency gate is triggered at the same point as the A-D conversion which could be significantly shorter than 1 second. This may reduce the read-rate, as the measurement processing cannot begin until both the frequency gate and the A-D conversion are complete.

Power On and Reset Conditions

FAST_ON.

Maximum, Minimum and Peak-Peak

Recall Stored Values

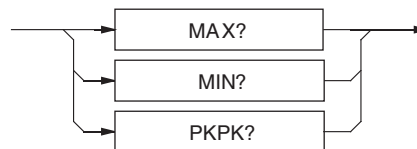

Recall Stored values

adj221f.eps

MAX?

Recalls the stored value of the maximum signal value to be measured since the most-recent general reset, store reset or function change.

MIN?

Recalls the stored value representing the minimum signal value to be measured since the most-recent general reset, store reset or function change.

PKPK?

Obtains the stored value representing the difference between the maximum and minimum signal values to be measured since the most-recent general reset, store reset or function change.

Response Format

(Nr3) Max or Min:

The returned value represents the signal with two exceptions:

- When an overload has occurred, and thus the maximum is not measurable, the response is +200.000000E+33.
- When no measurement has been made since a reset, the response is -20.0000000E+36.

(Nr3) PkPk:

The returned value represents the difference between the max and min signals with two exceptions:

- When an overload occurs in one or both stores, the computation is still performed and thus the response indicates a numeric difference which has an obviously overlarge exponent.
- When no measurement has been made since a reset, the response is -40.00000000E+36.

Function Change, Power On and Reset:

These automatically clear Max, Min, and thus PkPk values.

Reset Max and Min Memories

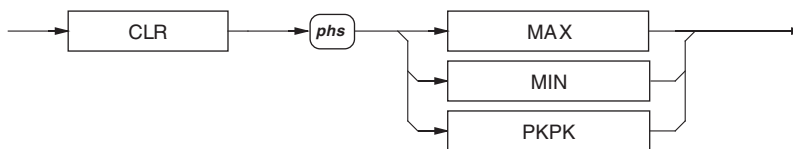

Reset Max and Min Memories

adj222f.eps

MAX / MIN

Resets the specified store only.

PKPK

Resets both the MAX and MIN stores.

Function Change, Power On and Reset:

These automatically clear Max, Min, and thus PkPk values.

Limits

Each command sets its corresponding limit, for comparison with each measurement when enabled.

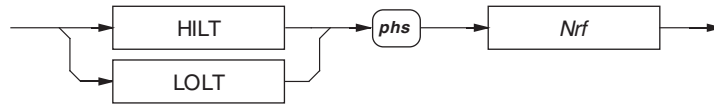

adj223f.eps

Setting Hi/Lo Limits

Nrf

A Decimal Numeric Data element that represents the mathematical value to be used for limit-checking. Its resolution is 8.5 significant digits; numbers in excess of this resolution will be rounded to it. The limits are stored in non volatile memory.

Recall Limits

Each of these queries recalls its corresponding limit value.

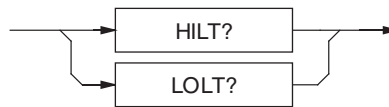

adj224f.eps

Recall Limits

HILT?

(Nr3) Recalls the set Hi Limit value.

LOLT?

(Nr3) Recalls the set Low limit value.

Enable Limits

These commands enable and disable the checking of measurements against preset limits.

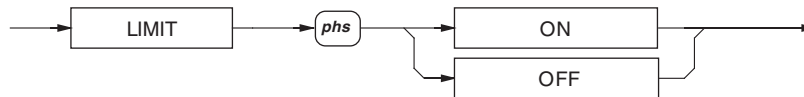

adj225f.eps

Enable Limits

Note

Limit calculations are performed after all math operations are complete. Thus the choice of limit values should be relevant to the result of the math operation on the measured signal.

Power On and Reset Conditions

OFF

Standard Deviation

Each of these queries recalls the stored standard deviations for a block of readings.

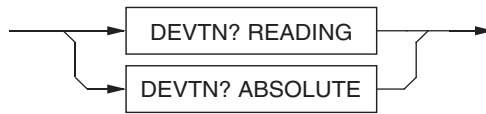

Recall Standard Deviation

adj363f.eps

DEVTN? READING

(Nr3) Recalls the standard deviation of the block relative to the mean of the block.

DEVTN? ABSOLUTE

(Nr3) Recalls the standard deviation of the block as an absolute quantity.

Note

To obtain a valid standard deviation value the AvR or BlocN average mode must be configured and enabled.

Syntax Diagrams of Math Functions

Note

Combinations of math operations are allowed, but they must be performed in the following order:

1. *Averaging (AVG)*
2. *Multiplication (MUL_M)*
3. *Subtraction (SUB_C)*
4. *Division (DIV_Z)*
5. *Decibels (DB).*

Averaging

Two forms of averaging are available:

- **Rolling Average**

Processes successive readings to provide a measurement which is the arithmetic mean of the most-recent "R" (4, 8, 16, 32 or 64) readings. When the window has filled with the selected number of readings, the earliest reading is discarded as each new reading is added. The mean is updated with every new reading.

- **Block Average**

Continuously calculates the arithmetic mean of successive readings until a block of "N" readings is complete, then presents the mean of the whole block. A new block of N readings is started, but the old block's mean remains on the display until the new block is completed, when the new mean is presented.

Enable Averaging

All selections are mutually exclusive.

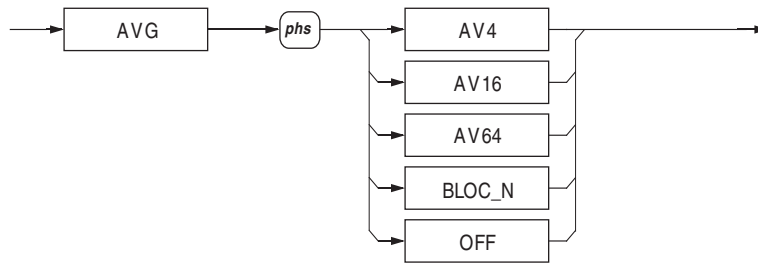

adj226f.eps

Enable Averaging

AVG AV...

Averages the number of readings requested (4, 16, or 64) as a rolling average.

Note

From a cleared average memory, the average is the mean of the number of readings to date, until the selection window number is reached. The average memories are cleared on each command update.

AVG BLOC_N

Selects N readings for a block average.

Note

The parameter BLOC_N selects the average of N readings, where only one result is obtained after the required number of readings (internally triggered) have been obtained.

AVG OFF

Turn averaging OFF; the number N is not destroyed.

Power On and Reset Conditions

OFF

Set Block Size

Sets the integer constant N for use with the averaging math function.



adj227f.eps

Set Block Size

Nrf

An integer value to be used as the number of readings to be taken and averaged in each block.. This value is saved in non volatile memory.

Example:

N 15 sets the number of readings to be averaged to 15.

Execution Errors

Execution errors will be generated when $N > 10,000$.

Power On and Reset Conditions: No Change. The number N is saved at Power Off.

Recall Block Size

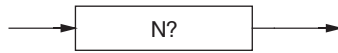

Recall block Size

adj228f.eps

N?

(Nr1) Recalls the active value of "N".

Multiplication

Each signal value is multiplied by a user-defined factor "M".

Enable Multiplication

Selects the multiplication operation to be performed on the measurement.

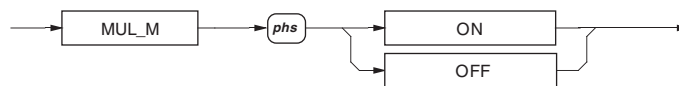

Enable Multiplication

adj229f.eps

Power On and Reset Conditions

OFF

Set Multiplication Constant

This command allows the definition of the factor M, to be used as the multiplication factor.

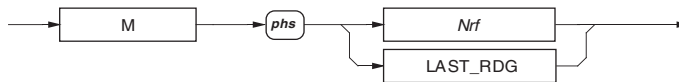

Set multiplication constant

adj230f.eps

Nrf

A numeric value required for use in the **MUL_M** command. The decimal data resolution is 8.5 digits; numbers exceeding this resolution will be rounded to 8.5 digits. This value is saved in non volatile memory.

Example:

M -3E+2 Sets M at -300.

LAST_RDG

Place the most recent reading into the numeric memory.

The mathematical processing capability is limited in the range of numbers which it can successfully handle. The maximum resolution of the mantissa is 8.5 digits, and the exponent is limited to ± 15 . Calculations which result in values outside this range will produce a mathematical overflow error.

Recall Multiplication Constant

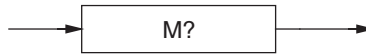

Recall Multiplication Constant

adj231f.eps

M?

(Nr3) Recalls the defined value of M.

Subtraction

A user-defined constant "C" is subtracted from each signal value.

Enable Subtraction

Selects the subtraction operation to be performed on the measurement.

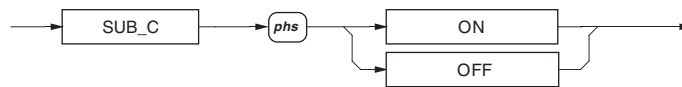

Enable Subtraction

adj232f.eps

Power On and Reset Conditions

OFF.

Set Subtraction Constant

This command allows the definition of the constant C.

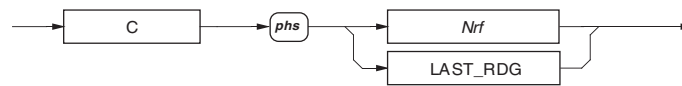

Set Subtraction Constant

adj233f.eps

Nrf

A numeric value required for use in the SUB_C processing. The decimal data resolution is 8.5 digits; numbers exceeding this resolution will be rounded to 8.5 digits. This value is saved in non volatile memory.

Example:

C 10E2 sets the C constant to 1000.

LAST_RDG

Places the most recent reading into the numeric store.

The mathematical processing capability is limited in the range of numbers which it can successfully handle. The maximum resolution of the mantissa is 8.5 digits, and the exponent is limited to ± 15 . Calculations which result in values outside this range will produce an error indicated by the invalid response when accessed by a query command.

Recall Subtraction Constant

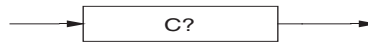

Recall Subtraction Constant

adj234f.eps

C?

(Nr3) Recalls the defined value of C.

Division

Each signal value is divided by a user-defined factor "Z".

Enable Division

Selects the division operation to be performed on the measurement.

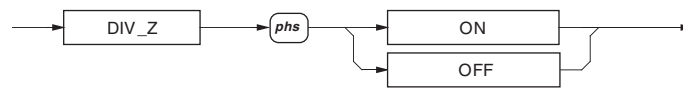

Enable Division

adj235f.eps

Power On and Reset Conditions

OFF

Set Division Constant

This command allows the definition of the factor Z.

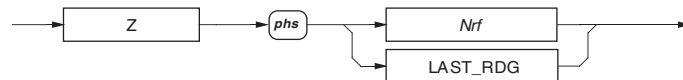

Set Division Constant

adj236f.eps

Nrf

A numeric value required for use in the DIV_Z processing. The decimal data resolution is 8.5 digits; numbers exceeding this resolution will be rounded to 8.5 digits. Divide by zero will set bit 5 (MOF) of the Measurement Event Status Byte. This value is saved in non volatile memory.

Example:

Z -56.999 sets Z to -56.999.

LAST_RDG

Places the most recent reading into the numeric memory.

The mathematical processing capability is limited in the range of numbers which it can successfully handle. The maximum resolution of the mantissa is 8.5 digits, and the exponent is limited to ± 15 . Calculations which result in values outside this range will produce an error indicated by the invalid response when accessed by a query command.

Recall Division Constant

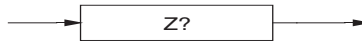

Recall Division Constant

adj237f.eps

Z?

(Nr3) Recalls the defined value of z.

Decibel Calculations

Decibel operations calculate, and express in decibels, the ratio of the reading to one of four standard references: unity, and 1 mW in either 50 Ω, 75 Ω or 600 Ω. As the dB calculation is set as the final part of any calculation, it is also possible to use the other Math operations to alter the effective reference value.

Enable dB Calculation

Selects the decibel operation to be performed on the measurement. This operation computes the dB ratio of a corrected A-D result and a stored reference value "R".

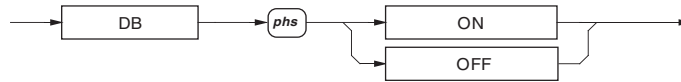

Enable dB Calculation

adj238f.eps

ON / OFF

Displays the result of the calculation $20\log[(\text{Reading})/\text{dB Ref}]$.

Power On and Reset Conditions

OFF.

Set dB Reference Value

The user defines the value of the reference R, to be used in dB calculation. All selections are mutually exclusive.

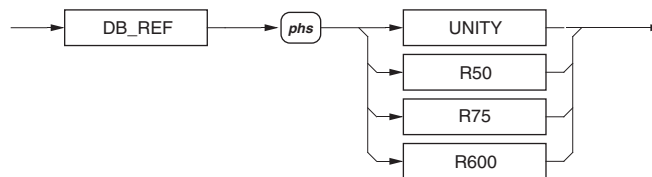

Set dB Reference

adj239f.eps

UNITY

Selects a dB reference of unity, in whole units of the active function.

Each of the following commands selects the dB reference voltage (as shown in parenthesis), which corresponds to 1 mW in the given impedance. These are only available for use in voltage functions

R50	50 Ω (i.e., 0.223606800V)
R75	75 Ω (i.e., 0.273861280V)
R600	600 Ω (i.e., 0.774596670V)

Power On and Reset Conditions

UNITY.

Recall dB Reference Value



Recall dB Reference Value

adj240f.eps

DB_REF?

(Nr3) Recalls the current value of the DB_REF voltage.

The value returned is the voltage value assigned to the program data elements:

The element UNITY: +1.00000000E+00.

The element R50: +223.606800E-03.

The element R75: +273.861280E-03.

The element R600: +774.596670E-03.

Syntax Diagram of Test

Selftest

This command conforms to the IEEE 488.2 standard requirements.



Selftest

adj241f.eps

***TST?**

Executes a selftest.

The success of Selftest can be inhibited by:

- Temperature not in the range: 5 °C to 40 °C.
- Presence of excessive RFI or Line noise.

Response

(Nr1) The value returned identifies pass (0) or failure (1) of self test. The errors numbers can be found in the device dependent error queue.

Execution Errors:

Selftest is not permitted when calibration is enabled.

Device Errors and Syntax Diagrams

Error Detection

All errors which cannot be recovered transparently result in some system action to inform the user via a message, and where possible restore the system to an operational condition. Errors are classified by the method with which they are handled.

- Recoverable errors report the error and continue.
- System errors which cannot be recovered cause the system to halt with a message displayed. Restarting the system from power on may clear the error, but generally such messages are caused by hardware or software faults.

A device-dependent error (DDE) is generated if the device detects an internal operating fault (e.g., during self-test). The **DDE** bit (3) is set *true* in the Standard-defined **Event Status Byte**, and the error code number is appended to the **Device-Dependent Error** queue.

In remote operations, the error is reported by the mechanisms described in the section which deals with status reporting, and the queue entries can be read destructively as LIFO by the query command **DDQ?**. The remote user can ignore the queue, but it is good practice to read the errors as they occur.

In local (front panel) operations, the DDE status is checked at the end of the operation (e.g., Cal, Zero, Test). If *true*, an error has occurred, and the content of the last entry in the queue is displayed on the front panel. The local user cannot continue until the queue has been read.

If both bus and front panel users attempt to read the queue concurrently, the error data is read out destructively on a first-come, first-served basis. Thus one of the users cannot read the data on one interface as it has already been destroyed by reading on the other. This difficulty should be solved by suitable application programming to avoid the possibility of a double readout. Ideally the IEEE 488 interface should set the instrument into REMS or RWLS to prevent confusion.

The code numbers for device dependent errors, with their associated descriptions, are given in Appendix A.

Recall Device Errors

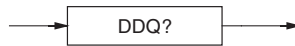

Recall Device Errors

adj243f.eps

DDQ?

Recalls the last error from the queue of device-dependent errors (e.g., errors recorded during a failed selftest). The queue is organized as a last-in - first-out stack, its individual entries being destructively read. If there are no entries in the queue, then use of this command generates a result of 0.

Note

Read the queue until empty. To prevent unrelated history of errors being retained, read the queue until empty on each occurrence of a device-dependent error.

Response

(Nr1) The value returned is a specified integer value indicating the fault.

Recall Execution Errors



Recall Execution Error

adj268f.eps

EXQ?

Recalls the last error from the queue of execution errors. An execution error occurs when a command cannot be complied with.

Read the Queue until Empty. It is good practice to read the queue until empty on each occurrence of execution error, to prevent unrelated history of errors being retained.

Response

(Nr1) The value returned is a integer value indicating the fault.

The execution error queue operates as a Last In - First Out stack, and individual entries are read destructively. If there are no entries in the queue, then use of this command produces a result of zero. For details of the number/fault relationship refer to Appendix A.

Power On and Reset Conditions

The queue is cleared.

Triggering and Reading Operations

Trigger Source Selector

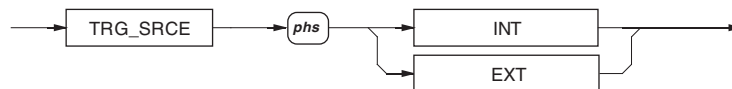

Trigger Source Selector

adj244f.eps

INT

Selects the internal interval counter as the source, and disables external trigger sources.

EXT

Disables internal triggers and enables three external trigger sources:

- Rear panel trigger socket.
- Controller-generated **GET** or ***TRG** commands.
- Front panel **Sample** key. This will have been disabled when the instrument was transferred from Local to Remote Control.

Selections are mutually exclusive.

Note

Internal triggers or uncontrolled rear panel triggers can produce unexpected results, due to the time required for the A-D conversion, and the A-D triggers being unsynchronized with the IEEE 488 bus operations. Such triggers should be avoided unless they form an essential ingredient of the required measurement.

Power On and Reset Conditions

INT.

Execute Trigger

This command conforms to the IEEE 488.2 standard requirements.



Execute Trigger

adj245f.eps

*TRG

Equivalent to a Group Execute Trigger (**GET**). Causes a single reading to be taken.

Execute Trigger and Take a Reading

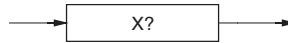

Execute Trigger and Take Reading

adj246f.eps

X?

Equivalent to performing an Execute Trigger (*TRG;RDG?) followed by a reading query. X? is intended for high speed use.

Settling Delay

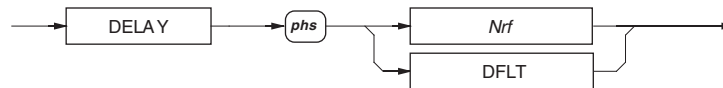

Setting Delay

adj247f.eps

Nrf

A numeric value for the required settle delay. The minimum period allowed is 0, and the maximum is 65,000 seconds.

Examples:

DELAY 0.001 sets a settle delay after trigger of 1ms before the reading begins

DELAY DFLT sets the default delay for the selected function, range, filter etc.

The programmed delay is active with TRG_SRCE EXT selected, although delays may be programmed whilst unit is in Remote with default (internal) triggers selected. They will then become active upon the selection of the external trigger.

Delay Selection Resolution

<0.01 s	10 μ s
0.01 s to 0.1 s	100 μ s
0.1 s to 1 s	1 ms
1 s to 10 s	10 ms
>10 s	100 ms

Execution Errors:

Execution errors are generated if an attempt is made to program the delays when the instrument is not in remote control.

An execution error is generated if the selected value of Nrf exceeds the limiting value.

Power On and Reset Conditions

DFLT

Delay Default Tables

The delays listed in the following tables are active unless a specific delay is programmed.

Once programmed, a specific delay will be applied to all subsequent readings providing External Trigger mode is selected until either the DELAY DFLT command is received, or the instrument is returned to local control. Delays then return to their default values.

Table 4-2. Delay Defaults for DCV, DCI, ACV, and ACI

Function	Filter.	Resolution			
		5	6	7	8
DCV	Out	0.08 s	0.1 s	1 s	5 s
	In	0.8 s	1 s	5 s	10 s
DCI	Out	0.08 s	0.1 s	0.1 s	---
	In	0.8 s	1 s	1 s	---
ACV Norm (Scan)	100 Hz	0.25 (0.5) s	0.3 (1.25) s	---	---
	40 Hz	0.6 (1.25) s	0.75 (3.25) s		
	10 Hz	2 (5) s	2.5 (12.5) s		
	1 Hz	20 (50) s	25 (125) s		
ACI	100 Hz	0.25 s	---	---	---
	40 Hz	0.6 s			
	10 Hz	2 s			
	1 Hz	20 s			

Table 4-3. Delay Defaults for Ohms, Tru Ohms, and Hi Ohms

Function	Filter	Resolution			
		5	6	7	8
1 Ω-100 kΩ	Out	0.8 s	1 s	5 s	10 s
	In	0.8 s	1 s	5 s	10 s
1 MΩ	Out	0.8 s	1 s	5 s	10 s
	In	2.5 s	3 s	5 s	10 s
10 MΩ	Out	2.5 s	3 s	5 s	10 s
	In	8 s	10 s	30 s	30 s
100 MΩ	Out	2.5 s	3 s	5 s	10 s
	In	8 s	10 s	30 s	30 s
1 GΩ	Out	2.5 s	3 s	5 s	10 s
	In	8 s	10 s	30 s	30 s
1 Ω-10 kΩ Tru Ohm	Out	0.08 s	0.1 s	1 s	5 s
	In	0.8 s	1 s	5 s	10 s
10/100 MΩ HV Ohm	Out	8 s	10 s	20 s	50 s
	In	25 s	30 s	50 s	50 s
1/10 GΩ HV Ohm	Out	10 s	10 s	20 s	50 s
	In	30 s	30 s	50 s	50 s

Input Zero

Determines and corrects for the input zero and stores the result in volatile memory. An Input Zero is stored only for the input channel selected. Each input has its own set of Input Zero stores, for all of the applicable range/function combinations. For OHMS function an independent Input Zero should be executed for the two/four wire connection and for the low/normal current selection. The PRT function utilizes input zero's obtained in the relevant OHMS/TRU_OHMS ranges.

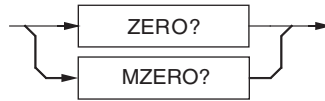

Input Zero

adj248f.eps

ZERO?

Causes an Input Zero operation to be executed for the selected range and function, if the instrument is not in a calibration mode.

MZERO?

Multiple ranges are zeroed for the selected function, starting at the highest range. If an error is detected further zeroing ceases.

Responses

The value returned (Nr1) identifies pass (0) or failure (1) of input zero. The error can be found in the device dependent error queue.

Execution Errors

Execution errors are generated if calibration is **enabled**, PRT function is selected or a scan operation is selected.

Wait

This command conforms to the IEEE 488.2 standard requirements.



Wait

adj249f.eps

*WAI

Prevents the instrument from executing any further commands or queries until the No Pending Operations Flag is set *true*. This is a mandatory command for IEEE-488.2 but has no relevance to this instrument as there are no parallel processes requiring Pending Operation Flags.

Reading Recall



Reading Recall - Voltage, Current and Resistance Readings

adj250f.eps

Voltage, Current and Resistance Readings

RDG?

(Nr3) Recalls the most recently triggered reading taken by the instrument.

If no trigger has been received to generate a conversion of the input signal, then the response to this command will represent the most-recent measurement. If a trigger has already been received, this query will wait for the completion of the measurement before placing the result in the output queue.

The value represents the applied signal together with any mathematical modifications selected with the Math facility. Overload is represented by a value of $\pm 200.0000E+33$ and the O-L bit set in the measurement event status register.

Power On and Reset Conditions

All previous results are cleared at power ON and Reset.

Frequency Readings



Reading Recall - Frequency Readings

adj251f.eps

FREQ?

(Nr3) Recalls the frequency associated with the most-recently triggered measurement.

A value of $200.0000E+33$ is returned if the measurement circuits cannot produce a result.

If no trigger has been received to generate a conversion of the input signal, then the response to this command will be the frequency of the most-recent measurement. If a trigger has already been received, this query will wait for the completion of the measurement before placing the result in the output queue.

Access to the Internal Buffer Memory

Set and Arm Block Measurement Mode



Set and Arm Block Measurement Mode

adj293f.eps

BLOCK

Arms the measurement system diversion of measurements to the internal buffer store, and enters the required number of diverted results.

Nrf

A numeric value for the number of measurements to be stored. This value must lie between 1 and 6000 measurements inclusive. Note that numbers will be rounded to an integer.

Putting Readings into Memory

Readings are placed into consecutive stores numbered from 1 to 6000. An example for a block of 16 readings is given below:

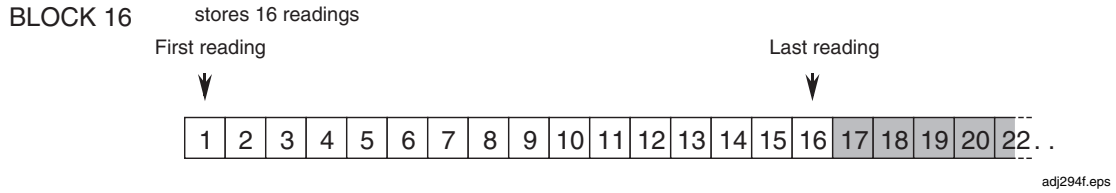

Block of 16 readings

At the completion of the block of measurements, bit 0 of the 8508A **Status Byte** is set, providing the appropriate bits of the **Service Request Enable** register (bit 0) and **Measurement Event Status Enable** register (bit 6) are set. Use of commands associated with this internal store prior to the completion of the specified number of readings, will abort the diversion of results.

Execution Errors

Occur when the numeric value exceeds the specified limits.

Power On and Reset Conditions

Diversion to the internal store is inoperative.

Note

*If **BLOCK phs Nrf** is selected in external trigger mode, **Nrf** triggers will be required to complete this sequence.*

Recall the Number of Results



Recall Number of Results

COUNT?

(Nr1) Recalls the number of measurements contained in the internal store.

If this command is used before a commanded block is complete, the diversion of measurements to store is aborted.

This number is set to zero when **BLOCK** command is executed.

Recall Measurements from Internal Memory



Recall Measurements from Internal Memory

BLOCK?

(Nr3) Recalls a series of readings between two store locations in the reading buffer. If this command is used before a commanded block is complete, the diversion of measurements to store is aborted.

Memory Locations

The first **Nrf** represents the location of the first reading of the series in the buffer, and the second **Nrf** represents the last reading of the series. All readings between these locations (inclusive) are recalled.

Example:

Locations of readings stored by BLOCK 16



BLOCK? 6,11 recalls selected readings consecutively from the stored block:

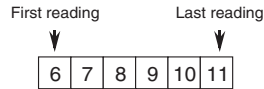

Block of 16 Readings

adj297f.eps

Execution Errors

Occur when the start point number is greater than the finish point number, or when the finish point number is greater than the number of readings actually saved. An execution error will also result from either of the numbers being zero.

Power On and Reset Conditions

No stored readings are available.

Internal Operations Commands

All of the commands under this heading are common commands defined in the IEEE-488.2 standard.

Reset



Reset

adj252f.eps

*RST

Resets the instrument to a defined condition.

The reset condition is independent of past-use history of the instrument except as noted below:

*RST does not affect the following:

- The selected address of the instrument
- Calibration data that affect specifications
- SRQ mask conditions
- Contents of the Status Byte Register and Event Status Register
- The state of the IEEE 488 interface
- Stored math constants.

The action of the front panel Reset key is not equivalent to *RST, but is a subset of it.

Complete Operations

*OPC

A synchronization command that generates an operation complete message in the standard **Event Status Register** when all pending operations have been processed by the parser.



Complete

adj253f.eps

OPC?

A synchronization command that places the ASCII character '1' in the output queue when all pending operations have been processed by the parser.



Complete?

adj254f.eps

Status Reporting

Most of the commands in this sub-section are standard reporting commands defined in the IEEE-488.2 standard.

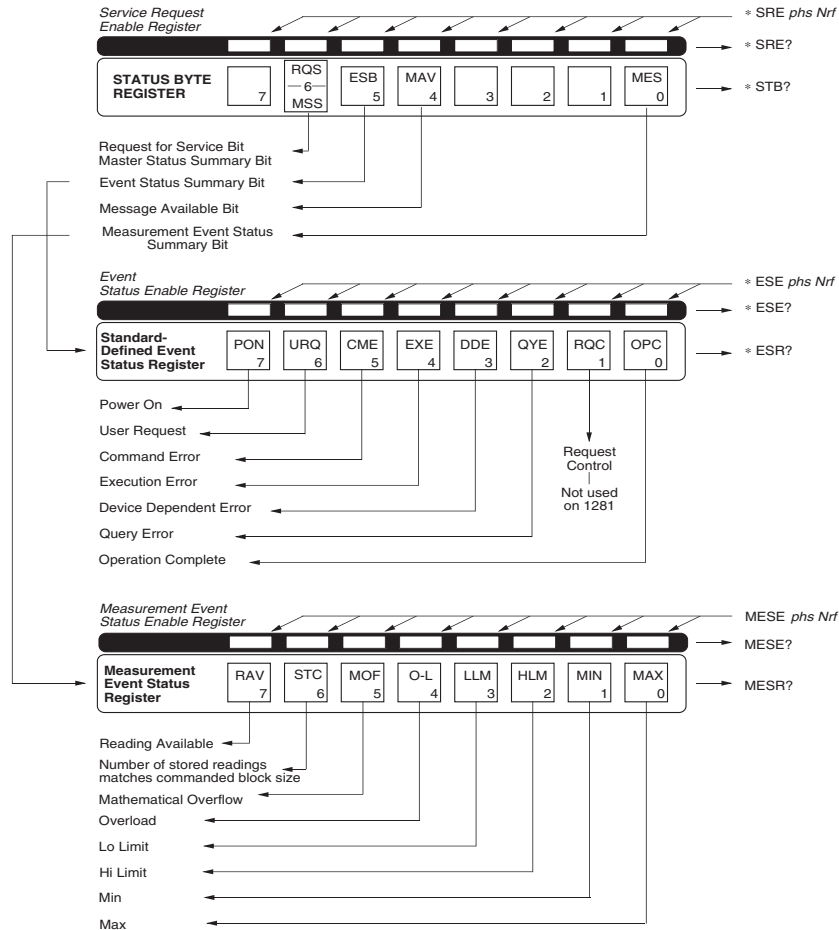

Status Data Structure

adj255f.eps

Read Service Request Register



Read Service Request Register

adj266f.eps

***STB?**

(Nr1) Recalls the service request register for summary bits. The returned value, when converted to base 2 (binary), identifies the summary bits as detailed in the status data structure diagram. There is no method of clearing this byte directly. Its condition relies on the clearing of the overlying status data structure.

Service Request Enable

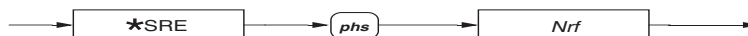

Service Request Enable

adj262f.eps

***SRE**

Enables the standard and user-defined summary bits in the service request byte, which will generate a service request.

Nrf

A number which, when rounded to an integer and expressed in base 2 (binary), enables the appropriate bits in this register. The detail definition is contained in the IEEE 488.2 document and in the status data structure diagram.

Recall Service Request Enable



Recall Service Request Enable

adj263f.eps

***SRE?**

(Nr1) Recalls the enable mask for the standard defined event register. The returned value, when converted to base 2 (binary), identifies the enabled bits which will generate a service request. The detail is contained in the IEEE 488.2 document and in the status data structure diagram.

Read Event Status Register



Read Event Status Register

adj259f.eps

***ESR?**

(Nr1) The value returned, when converted to base 2 (binary), identifies the bits as defined in the IEEE 488.2 standard and detailed in the status data structure diagram.

Power On and Reset Conditions

The Power On condition depends on the condition stored by the common *PSC command - if 0 then it is not cleared; if 1 then the register is cleared. Reset has no effect.

Event Status Enable



Event Status Enable

adj260f.eps

***ESE**

Enables the standard defined event bits which will generate a summary message in the status byte.

Nrf

A number which, when rounded to an integer and expressed in base 2 (binary), enables the appropriate bits in this event register. The detail definition is contained in the IEEE 488.2 document, and in the status data structure diagram.

Recall Event Status Enable



Recall Event Status Enable

adj261f.eps

***ESE?**

(Nr1) Recalls the enable mask for the standard defined event register. The returned value, when converted to base 2 (binary), identifies the bits as defined in the IEEE 488.2 standard and detailed in the status data structure diagram.

Power On and Reset Conditions

The Power ON condition depends on the condition stored by the common ***PSC** command - if 0 then it is not cleared; if 1 then the register is cleared. Reset has no effect.

Read Measurement Event Register



Read Measurement Event Register

adj258f.eps

MESR?

(Nr1) Destructively reads the measurement event register which, when converted to base 2 (binary), identifies the events that have occurred since the most-recent read or general clear of this register. The detail is contained in the status data structure diagram. The register is also cleared by the common command ***CLS**.

Power On and Reset Conditions

The register is cleared.

Measurement Event Enable

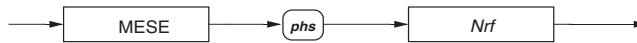

Measurement Event Enable

adj257f.eps

MESE

Enables the measurement event bits which will generate a summary message in the service request byte. See the device status reporting model for detail.

Nrf

A number which, when rounded to an integer and expressed in base 2 (binary), enables the appropriate bits in this event enable register.

Recall Measurement Event Enable

This measurement event status data structure conforms to the IEEE 488.2 standard requirements for this structure.



Recall Measurement Event Enable

adj256f.eps

MESE?

(Nr1) Recalls the measurement status register enable mask which, when converted to base 2 (binary), identifies the enabled bits which will generate a summary message in the service request byte.

Power On and Reset Conditions

Cleared (i.e., nothing enabled).

Clear Status



Clear Status

adj265f.eps

*CLS

Clears all the event registers and queues except the output queue. The output queue and **MAV** bit will be cleared if *CLS immediately follows a "Program Message Terminator".

Power On Status Clear



Power On Status Clear

adj264f.eps

*PSC

Sets the flag controlling the clearing of defined registers at Power On.

Nrf

A number which, when rounded to an integer value of zero, sets the *power on clear flag* false. This allows the instrument to assert **SRQ** at power on.

When the value rounds to an integer value other than zero it sets the *power on clear flag* true, which clears the standard *event status enable* and *service request enable* registers so that the instrument will not assert an SRQ on power up. This data is saved in non volatile memory for use at Power On.

Recall Status Clear Flag



Recall Power On Status Clear)

adj267f.eps

*PSC?

(Nr1) Recalls the saved Power On status condition: false (0) and true (1).

Instrument I/D and Setup

I/D (Identification)



I/D

adj269f.eps

*IDN?

Recalls the instrument's manufacturer, model number, serial number and firmware level.

Response

The data contained in the four comma separated fields is organized as follows:

- First field - Manufacturer
- Second field - Model
- Third field - Serial number
- Fourth field - Firmware level (issue.revision).

Options



Options

adj270f.eps

***OPT?**

(String) Recalls the instrument's option configuration which matches the options provided in the sales literature.

Example:

“8508A/01” -- for instrument fitted with rear terminals.

Setting Line Frequency

Selection of line frequency setting adjusts the integration time of the A-D converter for improved line frequency noise rejection.

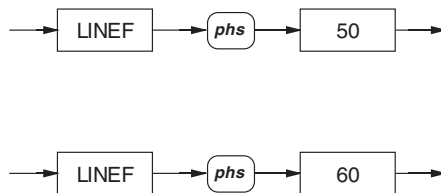

Setting Line Frequency 50 Hz or 60 Hz

adj281f.eps

LINEF 50

Selects a line frequency operation of 50Hz.

LINEF 60

Selects a line frequency operation of 60Hz.

The selection is saved in non volatile memory. *Note The only allowed values of **Nrf** are **50** for 50Hz, and **60** for 60Hz. Numbers exceeding the defined data element resolution will be rounded to that resolution.*

Power On and Reset Conditions

Reactivated at Power On

Recall of Line Frequency Setting



Recall Line Frequency Setting

adj282f.eps

LINEF?

(Nr1) Recalls the active setting for line frequency.

Calibration Commands and Messages

⚠⚠ Caution

The descriptions in the following pages are intended only as a guide to the messages available to calibrate the instrument. They contain neither examples nor calibration routines, and should NOT be used directly as a basis for calibrating any part of the instrument. Some of the commands, if used unwisely, will obliterate an expensive calibration or re-calibration.

Calibration Sequences

Remote calibration via the IEEE 488 system bus generally follows similar sequences (and is subject to similar constraints) as for local calibration. But because the remote method does not require a human operator to gain access to a sequence of commands via a single menu screen, it is possible to group commands together within bus message units.

For this reason the user should not always expect to find a one-to-one correspondence between the local and remote calibration commands.

Refer to Chapter 6 for details of the required calibration points and procedure.

Enable Calibration

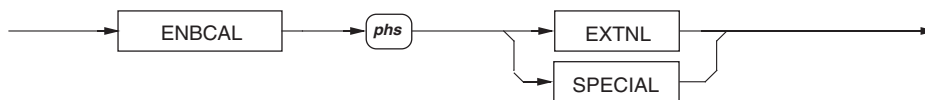

adj271f.eps

Enable Calibration

ENBCAL

Allows access to the calibration operations, provided the calibration key switch on the instrument rear panel is set to "ENABLE".

EXTNL

Selects the external calibration facility where the user supplies the calibration source signals and the calibration trigger commands.

SPECIAL

Allows access to a mode for 'special' calibrations and entry of protected data.

Execution Errors

An execution error is generated if the rear panel switch is not in the ENABLE position.

Power On and Reset Conditions

Calibration disabled.

Trigger "External Calibration"

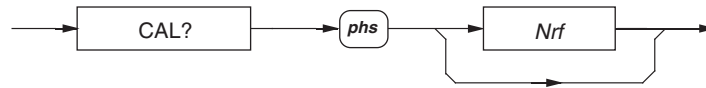

adj272f.eps

Trigger External Calibration

CAL?

Triggers an external calibration event, including the "SET" feature used for local calibration.

Nrf

A numeric value representing the "SET" calibration value. This is used as the target for the actual measured value. The difference between these two values is used to determine the calibration factors. The *Nrf* value is rounded to 8.5 digits resolution.

If the *Nrf* data element is included then *phs* is required. The number must conform to the limits required for the function being calibrated.

If the program header separator (*phs*) and *Nrf* are omitted, the instrument assumes that the nominal calibration point value is the target for the actual measured value.

Response

(Nr1) The value returned identifies the success (0) or failure (1) of the calibration exercise:

Execution Errors

If calibration is not enabled, or if the number used is incompatible with the setting being calibrated.

Select Spot Frequency

Selects the spot frequency store to be used by the calibration trigger (ACV only).

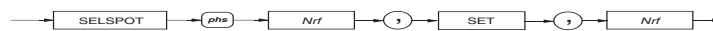

adj273f.eps

Spot Frequency

SELSPOT

Allows the user to select a spot frequency on the active ACV range by entering the spot number. The user then enters the target value that calibrates the selected spot.

1st Nrf

A decimal numeric data element representing the selected spot frequency store, from 1 to 6.

2nd Nrf

A decimal numeric element that represents the **SET** value to be applied. This value is preceded by the "SET" element. This is used as the target for the actual measured value.

The frequency that will be assigned to the spot number, is allocated by the Multimeter's frequency detector. To complete the calibration a calibration trigger is required (CAL?).

Numbers that exceed the required resolution will be rounded.

Execution Errors

If calibration is not enabled, or if the 1st *Nrf* is out of range.

Calibration Due Date



Calibration Due Date

adj275f.eps

EXT_DUE?

(String) Returns the user-entered recommended date for the re-calibration of the instrument. The date is that most-recently entered either as a parameter of **EXITCAL**, or when an exit was made from the front panel calibration mode.

Protected User Data

Entry of User Data

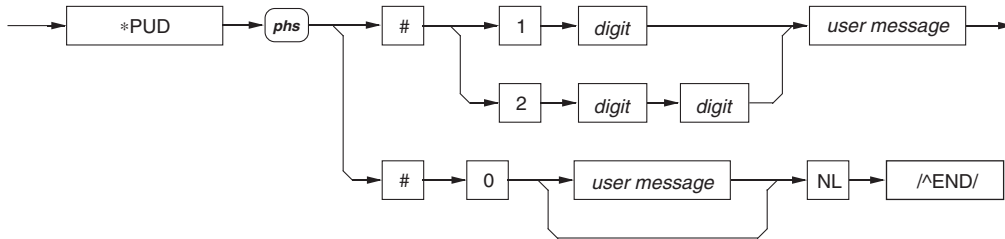

Protected User Data

adj277f.eps

where:

phs = Program Header Separator

digit = one of the ASCII-coded numerals

user message = any message up to 63 bytes maximum

*PUD

Allows a user to enter up to 63 bytes of data into a protected area to identify or characterize the instrument. The two representations above are allowed depending on the message length and the number of 'digits' required to identify this. The instrument must be in the calibration mode for this command to execute.

Execution Errors

Execution errors are generated if the instrument is not in calibration mode.

Recall of User Data

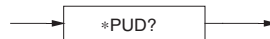

Recall User Data

adj278f.eps

*PUD?

Recalls previously entered user data: If no message is available, the value of the two digits is 00.

The data area contains 63 bytes of data.

Response Syntax



adj279f.eps

Response Syntax

where:

digit = one of the ASCII-coded numerals

user message = the saved user message

Special Calibrations

Perform a "Special" Calibration

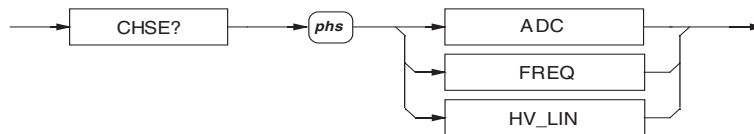

adj280f.eps

Special Calibration

CHSE?

Triggers special calibration

ADC

Aligns the different resolutions available from the analog to digital converter, so that there are no significant differences in readings when changing resolutions with a constant input value.

FREQ

Calibrates the frequency counter against an external frequency standard, by correcting an internal frequency 'gain' factor.

HV_LIN

ONLY used after the five linearity measurements have been taken using the command HV_LIN? <parameter>, to calculate the DC high voltage linearity correction from these measurements.

Response

(Nr1) The value returned identifies the success (0) or failure (1) of the calibration step.

Execution Errors

If special calibration is not enabled.

"Special" measurement commands for DCV Linearity Calculations

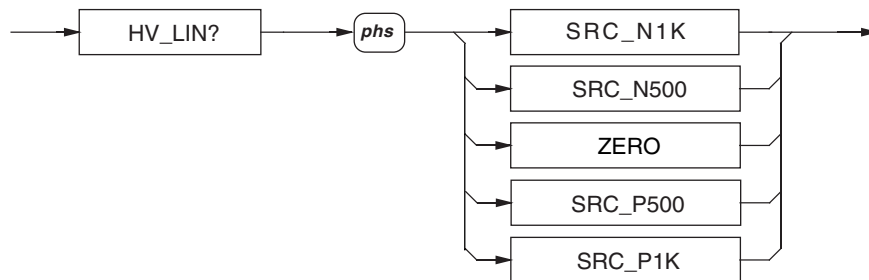

adj361f.eps

"Special" measurement commands for DCV Linearity Calculations

HV_LIN?

Triggers a measurement and records the result for use with the special calibration command CHSE? HV_LIN. The signal supplied for each measurement should match the supplied parameter.

SRC_N1K

Measurement source is -1000V DC.

SRC_N500

Measurement source is -500V DC.

ZERO

Measurement source is 0.0V DC.

SRC_P500

Measurement source is +500V DC.

SRC_P1K

Measurement source is +1000V DC.

Response

(Nr1) The value returned identifies the success (0) or failure (1) of the measurement.

Execution Errors

If special calibration is not enabled.

Exit from Calibration

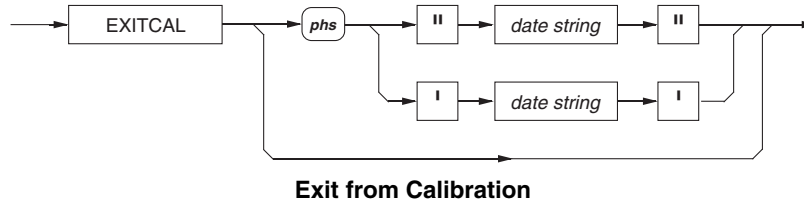

Exit from Calibration

adj284f.eps

EXITCAL

Exits calibration mode giving the operator the option of entering a due date, or bypassing it as shown in the syntax diagram.

Date string

Represents a string which should contain 8 ASCII characters, indicating the date next due for external calibration. Any format is suitable, and the date can be returned using the **EXT_DUE?** command. It can also be displayed by a front panel user, who can enter a new date only via the (protected) calibration mode menu.

Execution Errors

If the calibration switch is not in the enabled position.

Set Instrument Serial Number

This number is originally set at manufacture to match the serial number on the rear panel plate and stored in non-volatile RAM.

It can be changed only when in special calibration mode. User-access has been provided so that an inventory or asset number can be used to replace the manufacturer's serial number.

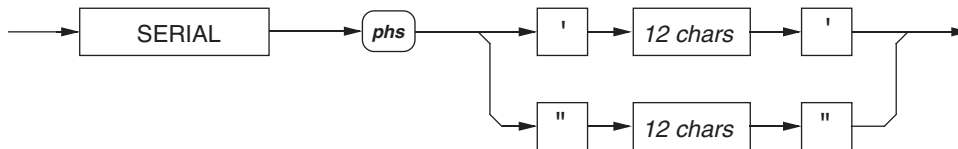

Set Instrument Serial Number

adj290f.eps

SERIAL

Allows access to change the serial number.

chars

ASCII printing characters.

The number is in quotes to allow a free format to be used for the serial number itself. It can be recalled together with the manufacturer's name, model number and firmware level, using the standard IEEE 488 identification message ***IDN?**

Execution Errors

Occur if special calibration is not enabled.

Clear Calibration Memory

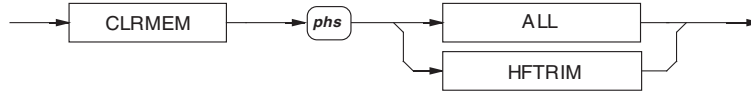

adj289f.eps

Clear Calibration Memory

CLRMEM

Clears the calibration correction memories.

⚠⚠ Caution

This command can obliterate the results of an expensive original calibration or re calibration!

The extent of clear is defined by programming the following options:

ALL

Clears all

HFTRIM

Clears AC HF frequency response correction only.

Execution Errors

If special calibration is not enabled.

Chapter 5

Specifications

Title	Page
Specifications.....	5-3
General Specifications.....	5-3
Maximum Voltage and Current Inputs.....	5-4
DC and AC Voltage.....	5-4
DC and AC Current.....	5-4
Resistance and Temperature.....	5-4
DC Voltage.....	5-5
DC Current.....	5-6
AC Voltage.....	5-7
AC Current.....	5-9
Resistance.....	5-11
Temperature.....	5-13
Read Rate and Additional Uncertainty.....	5-14
Applying the Specifications.....	5-15
Introduction.....	5-15
Absolute and Relative Specifications.....	5-15
Applying User's Calibration Uncertainties.....	5-16
Operating and Calibration Temperature Ranges.....	5-16
Applying Temperature Coefficient Specifications.....	5-16
Ratio Measurements.....	5-17
Additional Errors.....	5-17

Specifications

General Specifications

Power

Voltage

115 V Setting 100 V to 120 V rms ± 10 %

230 V Setting 200 V to 240 V rms ± 10 %

Frequency 47 Hz to 63 Hz

Consumption < 80 VA

Dimensions

Height 88 mm (3.5 inches)

Width 427 mm (16.8 inches)

Depth 487 mm (19.2 inches)

Weight 11.5 kg (25.5 lbs)

Environment

Temperature

Operating 0 °C to 50 °C

Specified Operation 5 °C to 40 °C

Calibration (TCal) 20 °C to 25 °C

Factory Cal Temp 23 °C

Storage -20 °C to 70 °C

Warm Up 4 hours to full uncertainty specification.

Relative Humidity (non- condensing)

Operating 5 °C to 40 °C < 90 %

Storage 0 °C to 70 °C < 95 %

Altitude

Operating < 2000 meters

Storage < 12000 meters

Vibration and Shock Complies with MIL-PRF-28800F Class 3.

Safety Designed and tested to EN61010-1: 2001, UL 61010-1A1, CAN/CSA-C22.2 No.61010.1, CE and ETL marked.
Pollution Degree 2.
Installation Category II.
Equipment Class I (single insulation / Earthed metal case).
Protection against water ingress IP4X (general indoor conditions).
Input circuitry and connections (creepage and clearances) designed to interface at Installation or Measurement Category I.

EMC EN50081-1 Class B, EN55011/22, EN61326-1:1998, EN50082-1, EN55011 1991 Class B, EN61000-6-1:2001, FCC Rules part 15 sub part J class B, CETL and CE marked.

Measurement Isolation

Guard to Safety Ground < 3300 pF, > 10 G Ω .

Lo to Guard

In Remote Guard < 2800 pF, > 10 G Ω (Not in Resistance function).

In Local Guard Lo and Guard terminals are internally shorted (in Resistance < 2800 pF, > 10 G Ω).

Autorange

Range Up 100 % of range.

Range Down 9 % of range (18 % on 1000 V range).

Remote Interface IEEE 488.2

Warranty 1 Year

Maximum Voltage and Current Inputs

Notes to maximum voltage and current input specifications

- Maximum DC input equal to maximum rms input. Maximum peak input is rms x 1.414
- Specifications apply equally to front and rear input terminals except where noted below.
- Front to rear isolation allows opposing polarity of maximum terminal voltage on each input.
- Digital I/O Ground (DigGnd) is internally connected to Safety Ground (Ground).

DC and AC Voltage

Maximum rms terminal voltages

					Sense Lo	Hi	Sense Hi
					250 V	1000 V	250 V
					Lo	Hi	1000 V
					1000 V	1000 V	1000 V
		A	1000 V	250 V	250 V	1000 V	1000 V
		Guard	1000 V	250 V	250 V	1000 V	1000 V
DigGnd		650 V	650 V	650 V	650 V	1000 V	1000 V
Ground	0 V	650 V	650 V	650 V	650 V	1000 V	1000 V

Notes

- The A terminal is open circuit in these functions.
- In 4wV mode Sense Hi is internally connected to Hi and Sense Lo is internally connected to Lo.

DC and AC Current

Maximum rms terminal voltages

					Sense Lo	Hi	Sense Hi
					250 V	1000 V	250 V
					Lo	Hi	1000 V
					5 V	1000 V	1000 V
		A	250 V	250 V	250 V	1000 V	1000 V
		Guard	250 V	250 V	250 V	1000 V	1000 V
DigGnd		650 V	650 V	650 V	650 V	1000 V	1000 V
Ground	0 V	650 V	650 V	650 V	650 V	1000 V	1000 V

Maximum rms terminal currents

	Guard	A	Lo	Sense Lo	Hi	Sense Hi
Front Input	n.a	20 A	20 A	n.a	n.a	n.a
Rear input	n.a	2 A	2 A	n.a	n.a	n.a

Notes

- The Sense Lo, Sense Hi, and Hi Terminals are open circuit in these functions.
- The front input A terminal protection is automatic and self-resetting, and does not interrupt current flow. Damage is likely to occur if more than 20 A is applied.
- The rear input A terminal is protected by a fuse mounted on the rear panel.

Resistance and Temperature

Maximum rms terminal voltages

					Sense Lo	Hi	Sense Hi
					250 V	250 V	250 V
					Lo	Hi	250 V
					250 V	250 V	250 V
		A	250 V	250 V	250 V	250 V	250 V
		Guard	250 V	250 V	250 V	250 V	250 V
DigGnd		650 V	650 V	650 V	650 V	1000 V	1000 V
Ground	0 V	650 V	650 V	650 V	650 V	1000 V	1000 V

Note

- The A terminal is open circuit in these functions.

DC Voltage

DC Voltage ^{[1] [2] [3]}

Range	Full Scale	Uncertainty Relative to Cal Stds			Absolute Uncertainties	
		± (ppm Reading + ppm Range) ^[4]				
		24 hour TCal ±1 °C	90 day TCal ±1 °C	365 day TCal ±1 °C	365 day TCal ±1 °C	365 day TCal ±5 °C
95 % Confidence Level						
200 mV	199.990 000	0.7 + 0.5	1.4 + 0.5	2.7 + 0.5	4.5 + 0.5	5.0 + 0.5
2 V	1.999 900 00	0.5 + 0.2	1.4 + 0.2	2.7 + 0.2	3.0 + 0.2	3.5 + 0.2
20 V	19.999 000 0	0.5 + 0.2	1.4 + 0.2	2.7 + 0.2	3.0 + 0.2	3.5 + 0.2
200 V	199.990 000	1.0 + 0.2	2.6 + 0.2	4.0 + 0.2	4.5 + 0.2	5.5 + 0.2
1000 V	1050.000 00	1.0 + 0.5	2.6 + 0.5	4.0 + 0.5	4.5 + 0.5	5.5 + 0.5
99 % Confidence Level						
200 mV	199.990 000	0.8 + 0.6	2.0 + 0.6	3.5 + 0.6	6.0 + 0.6	6.5 + 0.6
2 V	1.999 900 00	0.6 + 0.25	1.8 + 0.25	3.5 + 0.25	4.0 + 0.25	4.5 + 0.25
20 V	19.999 000 0	0.6 + 0.25	1.8 + 0.25	3.5 + 0.25	4.0 + 0.25	4.5 + 0.25
200 V	199.990 000	1.2 + 0.25	3.5 + 0.25	5.2 + 0.25	6.0 + 0.25	7.0 + 0.25
1000 V	1050.000 00	1.2 + 0.6	3.5 + 0.6	5.2 + 0.6	6.0 + 0.6	7.0 + 0.6

DC Voltage (Secondary Specifications) ^{[1] [2] [3]}

Range	Transfer Uncertainty 20 mins ±1 °C ± (ppm Reading+ ppm Range)	Temperature Coefficient	
		15 °C - 30 °C	5 °C - 15 °C 30 °C - 40 °C
		± ppm Reading/°C	
200 mV	0.4 + 0.3	0.4	0.6
2 V	0.12 + 0.1	0.3	0.5
20 V	0.12 + 0.1	0.3	0.5
200 V	0.4 + 0.1	0.7	1.0
1000 V	0.4 + 0.3	0.7	1.0

Type Multi-slope, multi-cycle A-D Converter

CMRR (1 KΩ unbalance) ^[5] 140 dB at DC and 1 - 60 Hz

NMRR ^[5]

Filter Out 60 dB at 50/60 Hz ±0.09 %

Filter In 110 dB at 50/60 Hz ±0.09 %

Protection (All ranges) 1 kV rms

Input Impedance

200 mV to 20 V Ranges > 10 GΩ

200 V & 1000 V Ranges 10.1 MΩ ± 1 %

Max Input Current 50 pA

Ratio Accuracy

Range to Range ±(Net Front Input Accuracy + Net Rear Input Accuracy)

Within Range Apply 24 hour or 20 minute Transfer Uncertainty specifications

Settling Time (to 10 ppm step size)

Filter Out < 50 ms

Filter In < 1 s

DC Current

DC Current ^{[1] [2] [3]}

Range	Full Scale	Uncertainty Relative to Cal Stds			Absolute Uncertainties	
		± (ppm Reading + ppm Range) ^[4]				
		24 hour TCal ±1 °C	90 day TCal ±1 °C	365 day TCal ±1 °C	365 day TCal ±1 °C	365 day TCal ±5 °C
95 % Confidence Level						
200 µA	199.990 00	5.5 + 2.0	6.0 + 2.0	6.5 + 2.0	12 + 2.0	12 + 2.0
2 mA	1.999 900 0	5.5 + 2.0	6.0 + 2.0	6.5 + 2.0	12 + 2.0	12 + 2.0
20 mA	19.999 000	6.5 + 2.0	7.0 + 2.0	8.0 + 2.0	13 + 2.0	14 + 2.0
200 mA	199.990 00	28 + 4.0	30 + 4.0	33 + 4.0	36 + 4.0	48 + 4.0
2 A	1.999 900 0	80 + 8.0	125 + 8.0	170 + 8.0	170 + 8.0	185 + 8.0
20 A	19.999 000	200 + 20	290 + 20	380 + 20	380 + 20	400 + 20
99 % Confidence Level						
200 µA	199.990 00	7.0 + 2.0	7.5 + 2.0	8.0 + 2.0	15 + 2.0	16 + 2.0
2 mA	1.999 900 0	7.0 + 2.0	7.5 + 2.0	8.0 + 2.0	15 + 2.0	16 + 2.0
20 mA	19.999 000	8.0 + 2.0	9.0 + 2.0	10 + 2.0	16 + 2.0	18 + 2.0
200 mA	199.990 00	35 + 4.0	37 + 4.0	40 + 4.0	45 + 4.0	60 + 4.0
2 A	1.999 900 0	100 + 8.0	150 + 8.0	205 + 8.0	210 + 8.0	225 + 8.0
20 A	19.999 000	250 + 20	350 + 20	450 + 20	455 + 20	500 + 20

DC Current (Secondary Specifications) ^{[1] [2] [3]}

Range	Input Impedance (Ω)		Temperature Coefficient	
			15 °C - 30 °C	5 °C - 15 °C 30 °C - 40 °C
	Front	Rear	± ppm Reading/°C	
200 µA	150	150	0.4	0.6
2 mA	15.2	15.2	0.4	0.6
20 mA	1.8	1.9	1.2	1.8
200 mA	1.2	1.3	6.0	9.0
2 A	0.3	0.4	8.0	12
20 A	0.04	-	15	20

Type..... Multi-slope, multi-cycle A-D Converter

Protection

Front Input..... 20 A rms

Rear Input 2 A rms, Rear Panel Fuse

Settling Time

200 µA to 200 mA Ranges, to 10 ppm step size Filter Out < 50 ms, Filter In < 1 s

2 A Range to 10 ppm step size..... < 1 s

20 A Range to 100 ppm step size..... < 30 s

AC Voltage

AC Voltage ^{[1] [2] [6] [7]}

Range	Full Scale	Frequency (Hz)	Uncertainty Relative to Cal Stds			Absolute Uncertainties ^[9]	
			± (ppm Reading + ppm Range) ^[4]				
			24 hour TCal ±1 °C	90 day TCal ±1 °C	365 day TCal ±1 °C	365 day TCal ±1 °C	365 day TCal ±5 °C
95% Confidence Level							
200 mV	199.990 0	1 - 10	80 + 70	120 + 70	120 + 70	160 + 70	165 + 70
		10 - 40	80 + 20	120 + 20	120 + 20	130 + 20	140 + 20
		40 - 100	60 + 20	100 + 20	100 + 20	110 + 20	115 + 20
		100 - 2 k	40 + 10	100 + 10	100 + 10	105 + 10	110 + 10
		2 k - 10 k	60 + 20	100 + 20	100 + 20	105 + 20	135 + 20
		10 k - 30 k	250 + 30	300 + 40	300 + 40	305 + 40	340 + 40
30 k - 100 k	400 + 100	700 + 100	700 + 100	705 + 100	765 + 100		
2 V, 20 V & 200 V	1.999 900 19.999 00 199.990 0	1 - 10	70 + 60	100 + 60	100 + 60	140 + 60	150 + 60
		10 - 40	70 + 10	100 + 10	100 + 10	105 + 10	115 + 10
		40 - 100	50 + 10	80 + 10	80 + 10	85 + 10	90 + 10
		100 - 2 k	30 + 10	60 + 10	60 + 10	65 + 10	75 + 10
		2 k - 10 k	50 + 10	80 + 10	80 + 10	85 + 10	110 + 10
		10 k - 30 k	100 + 20	200 + 20	200 + 20	205 + 20	220 + 20
30 k - 100 k	250 + 100	500 + 100	500 + 100	505 + 100	570 + 100		
100 k - 300 k	0.15 % + 0.1 %	0.3 % + 0.1 %	0.3 % + 0.1 %	0.3 % + 0.1 %	0.3 % + 0.1 %	0.3 % + 0.1 %	
300 k - 1 M	1 % + 0.5 %	1 % + 1 %	1 % + 1 %	1 % + 1 %	1 % + 1 %	1 % + 1 %	
1000 V ^[8]	1050.000	1 - 10	70 + 70	100 + 70	100 + 70	140 + 70	150 + 70
		10 - 40	70 + 20	100 + 20	100 + 20	110 + 20	120 + 20
		40 - 10 k	50 + 20	80 + 20	80 + 20	95 + 20	115 + 20
		10 k - 30 k	100 + 40	200 + 40	200 + 40	205 + 40	225 + 40
		30 k - 100 k	250 + 200	500 + 200	500 + 200	510 + 200	580 + 200
99% Confidence Level							
200 mV	199.990 0	1 - 10	90 + 80	140 + 80	140 + 80	200 + 80	210 + 80
		10 - 40	90 + 25	140 + 25	140 + 25	145 + 25	160 + 25
		40 - 100	70 + 25	115 + 25	115 + 25	125 + 25	135 + 25
		100 - 2 k	45 + 12	115 + 12	115 + 12	125 + 12	135 + 12
		2 k - 10 k	70 + 25	115 + 25	115 + 25	125 + 25	165 + 25
		10 k - 30 k	270 + 35	340 + 50	340 + 50	345 + 50	395 + 50
30 k - 100 k	450 + 120	750 + 120	750 + 120	755 + 120	855 + 120		
2 V, 20 V & 200 V	1.999 900 19.999 00 199.990 0	1 - 10	80 + 70	115 + 70	115 + 70	180 + 70	190 + 70
		10 - 40	80 + 12	115 + 12	115 + 12	120 + 12	135 + 12
		40 - 100	60 + 12	90 + 12	90 + 12	95 + 12	110 + 12
		100 - 2 k	35 + 12	70 + 12	70 + 12	75 + 12	90 + 12
		2 k - 10 k	60 + 12	90 + 12	90 + 12	95 + 12	135 + 12
		10 k - 30 k	115 + 25	240 + 25	240 + 25	245 + 25	260 + 25
30 k - 100 k	270 + 120	550 + 120	550 + 120	555 + 120	650 + 120		
100 k - 300 k	0.15 % + 0.12 %	0.3 % + 0.12 %	0.3 % + 0.12 %	0.3 % + 0.12 %	0.3 % + 0.12 %	0.3 % + 0.12 %	
300 k - 1 M	1 % + 0.6 %	1 % + 1.2 %	1 % + 1.2 %	1 % + 1.2 %	1 % + 1.2 %	1 % + 1.2 %	
1000 V ^[8]	1050.000	1 - 10	80 + 80	115 + 80	115 + 80	180 + 80	190 + 80
		10 - 40	80 + 25	115 + 25	115 + 25	135 + 25	145 + 25
		40 - 10 k	60 + 25	90 + 25	90 + 25	110 + 25	140 + 25
		10 k - 30 k	115 + 50	240 + 50	240 + 50	250 + 50	265 + 50
		30 k - 100 k	270 + 250	600 + 250	600 + 250	615 + 250	700 + 250

AC Voltage (Secondary Specifications) ^{[1] [2]}

Range	Frequency (Hz)	Temperature Coefficient	
		15 °C - 30 °C	5 °C - 15 °C 30 °C - 40 °C
		± ppm Reading/°C	
200 mV	1 - 10	5	10
	10 - 40	5	10
	40 - 100	5	10
	100 - 2 k	5	10
	2 k - 10 k	12	20
	10 k - 30 k	15	20
	30 k - 100 k	40	60
2 V 20 V 200 V	1 - 10	5	10
	10 - 40	5	10
	40 - 100	5	10
	100 - 2 k	5	10
	2 k - 10 k	10	15
	10 k - 30 k	12	20
	30 k - 100 k	40	60
	100 k - 300 k	60	90
	300 k - 1 M	80	120
1000 V	1 - 10	5	10
	10 - 40	5	10
	40 - 10 k	10	15
	10 k - 30 k	12	20
	30 k - 100 k	40	60

Type True RMS, AC coupled measures AC component with up to 1000 V
DC bias on any range. DC coupled gives $\sqrt{(ac^2 + dc^2)}$

CMRR (1 kΩ unbalance) ^[5] > 90 dB DC - 60 Hz

Crest Factor

200 mV to 200 V ranges 10:1 at 12% range, 5:1 at 50% range, 2.5:1 at full range

1000 V range 10:1 at 25% range, 5:1 at full range

Protection (All ranges) 1 kV rms

Input Impedance 1 MΩ in parallel with 150 pF

DC Accuracy (DC Coupled) Add ±(50 ppm Reading + 50 ppm Range + 20 μV)

Ratio Accuracy

Range to Range ±(Net Front Input Accuracy + Net Rear Input Accuracy)

Within Range Apply 24 hour or 20 minute Transfer Uncertainty specifications

Settling Time (to 100 ppm step size)

100 Hz < 0.5 s

40 Hz < 1.25 s

10 Hz < 5 s

1 Hz < 50 s

Frequency Measurement

Signal Amplitude Range 5 % of range to limit set by maximum V/Hz

Gate Mode	Normal	Fast
Resolution	6.5 digits	4.5 digits
Frequency Range	10 Hz - 1 MHz	200 Hz - 1 MHz
Accuracy (1 year, 13 °C - 33 °C)	± (10 ppm of Reading + 2 digits)	± 2 digits
Sample Interval	1 s	50 ms

AC Current

AC Current ^{[1] [2] [6] [9]}

Range	Full Scale	Frequency (Hz)	Uncertainty Relative to Cal Stds			Absolute Uncertainties ^[9]	
			± (ppm Reading + ppm Range) ^[4]				
			24 hour TCal ±1 °C	90 day TCal ±1 °C	365 day TCal ±1 °C	365 day TCal ±1 °C	365 day TCal ±5 °C
95% Confidence Level							
200 µA	199.990 0	1 - 10	200 + 100	250 + 100	250 + 100	475 + 100	500 + 100
		10 - 10 k	200 + 100	250 + 100	250 + 100	475 + 100	500 + 100
		10 k - 30 k	500 + 100	600 + 100	600 + 100	650 + 100	710 + 100
		30 k - 100 k	0.35 % + 100	0.4 % + 100	0.4 % + 100	0.4 % + 100	0.4 % + 100
2 mA & 20 mA	1.999 900 19.9990 00	1 - 10	200 + 100	250 + 100	250 + 100	290 + 100	310 + 100
		10 - 10 k	200 + 100	250 + 100	250 + 100	280 + 100	300 + 100
		10 k - 30 k	500 + 100	600 + 100	600 + 100	650 + 100	710 + 100
		30 k - 100 k	0.35 % + 100	0.4 % + 100	0.4 % + 100	0.4 % + 100	0.4 % + 100
200 mA	199.990 0	10 - 10 k	200 + 100	250 + 100	250 + 100	475 + 100	500 + 100
		10 k - 30 k	500 + 100	600 + 100	600 + 100	650 + 100	710 + 100
		30 k - 100 k	0.35 % + 100	0.4 % + 100	0.4 % + 100	0.4 % + 100	0.4 % + 100
2 A	1.999 900	10 - 2 k	500 + 100	600 + 100	600 + 100	600 + 100	620 + 100
		2 k - 10 k	600 + 100	700 + 100	700 + 100	700 + 100	725 + 100
		10 k - 30 k	0.25 % + 100	0.3 % + 100	0.3 % + 100	0.3 % + 100	0.3 % + 100
20 A	19.999 00	10 - 2 k	700 + 100	800 + 100	800 + 100	800 + 100	820 + 100
		2 k - 10 k	0.2 % + 100	0.25 % + 100	0.25 % + 100	0.25 % + 100	0.25 % + 100
99% Confidence Level							
200 µA	199.990 0	1 - 10	250 + 120	300 + 120	300 + 120	590 + 120	620 + 120
		10 - 10 k	250 + 120	300 + 120	300 + 120	590 + 120	620 + 120
		10 k - 30 k	600 + 120	700 + 120	700 + 120	775 + 120	800 + 120
		30 k - 100 k	0.35 % + 120	0.4 % + 120	0.4 % + 120	0.4 % + 120	0.4 % + 120
2 mA & 20 mA	1.999 900 19.999 00	1 - 10	250 + 120	300 + 120	300 + 120	380 + 120	400 + 120
		10 - 10 k	250 + 120	300 + 120	300 + 120	340 + 120	370 + 120
		10 k - 30 k	600 + 120	700 + 120	700 + 120	775 + 120	800 + 120
		30 k - 100 k	0.35 % + 120	0.4 % + 120	0.4 % + 120	0.4 % + 120	0.4 % + 120
200 mA	199.990 0	1 - 10	250 + 120	300 + 120	300 + 120	380 + 120	400 + 120
		10 - 10 k	250 + 120	300 + 120	300 + 120	305 + 120	360 + 120
		10 k - 30 k	600 + 120	700 + 120	700 + 120	700 + 120	740 + 120
2 A	1.999 900	10 - 2 k	600 + 120	700 + 120	700 + 120	705 + 120	725 + 120
		2 k - 10 k	700 + 120	800 + 120	800 + 120	815 + 120	860 + 120
		10 k - 30 k	0.25 % + 120	0.3 % + 120	0.3 % + 120	0.3 % + 120	0.3 % + 120
20 A	19.999 00	10 - 2 k	800 + 120	900 + 120	900 + 120	900 + 120	920 + 120
		2 k - 10 k	0.2 % + 120	0.25 % + 120	0.25 % + 120	0.25 % + 120	0.25 % + 120

Resistance

Resistance ^{[1] [2] [3] [9]}

Range	Full Scale	Mode ^[10]	Uncertainty Relative to Cal Stds			Absolute Uncertainties	
			± (ppm Reading + ppm Range) ^[4]				
			24 hour TCal ±1 °C	90 day TCal ±1 °C	365 day TCal ±1 °C	365 day TCal ±1 °C	365 day TCal ±5 °C
95% Confidence Level							
2 Ω	1.999 900 00	Normal	5.0 + 2.0	8.0 + 2.0	10 + 2.0	15 + 2.0	17 + 2.0
20 Ω	19.999 000 0	Normal	2.5 + 0.7	4.5 + 0.7	7.0 + 0.7	9.0 + 0.7	9.5 + 0.7
200 Ω	199.990 000	Normal	1.5 + 0.25	4.0 + 0.25	7.0 + 0.25	7.5 + 0.25	8.0 + 0.25
2 kΩ	1.999 900 00	Normal	1.0 + 0.25	3.5 + 0.25	7.0 + 0.25	7.5 + 0.25	8.0 + 0.25
20 kΩ	19.999 000 0	Normal	1.0 + 0.25	3.5 + 0.25	7.0 + 0.25	7.5 + 0.25	8.0 + 0.25
200 kΩ	199.990 000	Normal	1.0 + 0.25	3.5 + 0.25	7.0 + 0.25	7.5 + 0.25	8.0 + 0.25
2 MΩ	1.999 900 00	Normal	2.0 + 0.5	4.0 + 0.5	7.0 + 0.5	8.5 + 0.5	9.0 + 0.5
20 MΩ	19.999 000 0	Normal	3.5 + 5.0	6.0 + 5.0	9.0 + 5.0	15 + 5.0	20 + 5.0
200 MΩ	199.990 000	Normal	20 + 50	25 + 50	30 + 50	60 + 50	120 + 50
2 GΩ	1.999 900 00	Normal	250 + 500	350 + 500	500 + 500	525 + 500	1510 + 500
2 Ω	1.999 900 00	Lo Current	5.0 + 2.0	8.0 + 2.0	10 + 2.0	15 + 2.0	17 + 2.0
20 Ω	19.999 000 0	Lo Current	2.5 + 0.7	4.5 + 0.7	7.0 + 0.7	9.0 + 0.7	9.5 + 0.7
200 Ω	199.990 000	Lo Current	2.5 + 0.7	5.0 + 0.7	7.0 + 0.7	7.5 + 0.7	8.0 + 0.7
2 kΩ	1.999 900 00	Lo Current	2.5 + 0.7	5.0 + 0.7	7.0 + 0.7	7.5 + 0.7	8.0 + 0.7
20 kΩ	19.999 000 0	Lo Current	2.5 + 0.7	5.0 + 0.7	7.0 + 0.7	7.5 + 0.7	8.0 + 0.7
200 kΩ	199.990 000	Lo Current	5.0 + 0.5	6.5 + 0.5	7.0 + 0.5	7.5 + 0.5	8.0 + 0.5
2 MΩ	1.999 900 00	Lo Current	7.0 + 0.5	8.0 + 0.5	9.0 + 0.5	10 + 0.5	15 + 0.5
20 MΩ	19.999 000 0	Lo Current	20 + 5.0	20 + 5.0	25 + 5.0	35 + 5.0	90 + 5.0
200 MΩ	199.990 000	Lo Current	250 + 500	350 + 500	500 + 500	515 + 500	1505 + 500
2 GΩ	1.999 900 00	Lo Current	250 + 500	350 + 500	500 + 500	525 + 500	1510 + 500
20 MΩ	19.999 000 0	High Voltage	2.0 + 0.5	4.0 + 0.5	7.0 + 0.5	15 + 0.5	17 + 0.5
200 MΩ	199.990 000	High Voltage	3.5 + 5.0	6.0 + 5.0	9.0 + 5.0	60 + 5.0	65 + 5.0
2 GΩ	1.999 900 00	High Voltage	20 + 50	25 + 50	30 + 50	150 + 50	180 + 50
20 GΩ	19.999 000 0	High Voltage	250 + 500	350 + 500	500 + 500	525 + 500	1510 + 500
99% Confidence Level							
2 Ω	1.999 900 00	Normal	6.0 + 2.5	10 + 2.5	12 + 2.5	19 + 2.5	22 + 2.5
20 Ω	19.999 000 0	Normal	3.0 + 0.9	5.5 + 0.9	8.5 + 0.9	11.5 + 0.9	12.0 + 0.9
200 Ω	199.990 000	Normal	1.8 + 0.3	5.0 + 0.3	8.5 + 0.3	9.5 + 0.3	10 + 0.3
2 kΩ	1.999 900 00	Normal	1.2 + 0.3	4.5 + 0.3	8.5 + 0.3	9.5 + 0.3	10 + 0.3
20 kΩ	19.999 000 0	Normal	1.2 + 0.3	4.5 + 0.3	8.5 + 0.3	9.5 + 0.3	10 + 0.3
200 kΩ	199.990 000	Normal	1.2 + 0.3	4.5 + 0.3	8.5 + 0.3	9.5 + 0.3	10 + 0.3
2 MΩ	1.999 900 00	Normal	2.5 + 0.6	5.0 + 0.6	8.5 + 0.6	10.5 + 0.6	12 + 0.6
20 MΩ	19.999 000 0	Normal	4.5 + 6.0	7.5 + 6.0	12 + 6.0	20 + 6.0	25 + 6.0
200 MΩ	199.990 000	Normal	25 + 60	30 + 60	35 + 60	75 + 60	150 + 60
2 GΩ	1.999 900 00	Normal	325 + 600	450 + 600	650 + 600	675 + 600	1810 + 600
2 Ω	1.999 900 00	Lo Current	6.0 + 2.5	10 + 2.5	12 + 2.5	19 + 2.5	22 + 2.5
20 Ω	19.999 000 0	Lo Current	3.0 + 0.9	5.5 + 0.9	8.5 + 0.9	11.5 + 0.9	12.0 + 0.9
200 Ω	199.990 000	Lo Current	3.0 + 0.9	6.5 + 0.9	8.5 + 0.9	9.5 + 0.9	10.0 + 0.9
2 kΩ	1.999 900 00	Lo Current	3.0 + 0.9	6.5 + 0.9	8.5 + 0.9	9.5 + 0.9	10.0 + 0.9
20 kΩ	19.999 000 0	Lo Current	3.0 + 0.9	6.5 + 0.9	8.5 + 0.9	9.5 + 0.9	10.0 + 0.9
200 kΩ	199.990 000	Lo Current	6.0 + 0.6	8.0 + 0.6	9.0 + 0.6	9.5 + 0.6	10.0 + 0.6
2 MΩ	1.999 900 00	Lo Current	8.0 + 0.6	10.0 + 0.6	12.0 + 0.6	13.0 + 0.6	17.0 + 0.6
20 MΩ	19.999 000 0	Lo Current	25 + 6.0	25 + 6.0	30 + 6.0	45 + 6.0	110 + 6.0
200 MΩ	199.990 000	Lo Current	325 + 600	450 + 600	650 + 600	670 + 600	1810 + 600
2 GΩ	1.999 900 00	Lo Current	325 + 600	450 + 600	650 + 600	675 + 600	1810 + 600
20 MΩ	19.999 000 0	High Voltage	2.5 + 0.6	5.0 + 0.6	8.5 + 0.6	19 + 0.6	20 + 0.6
200 MΩ	199.990 000	High Voltage	4.5 + 6.0	7.5 + 6.0	12 + 6.0	75 + 6.0	80 + 6.0
2 GΩ	1.999 900 00	High Voltage	25 + 60	30 + 60	35 + 60	195 + 60	230 + 60
20 GΩ	19.999 000 0	High Voltage	325 + 600	450 + 600	650 + 600	675 + 600	1810 + 600

Resistance - Normal Mode (Secondary Specifications) ^{[1] [2] [3] [10]}

Range	Measurement Current	Transfer Uncertainty 20 mins ± 1 °C \pm (ppm Reading + ppm Range)	Temperature Coefficient	
			15 °C - 30 °C	5 °C - 15 °C 30 °C - 40 °C
			\pm ppm Reading/°C	
2 Ω	100 mA	2.0 + 2.0	1.5	2.5
20 Ω	10 mA	0.8 + 0.7	0.6	1.0
200 Ω	10 mA	0.2 + 0.15	0.5	0.8
2 k Ω	1 mA	0.2 + 0.15	0.5	0.8
20 k Ω	100 μ A	0.2 + 0.15	0.5	0.8
200 k Ω	100 μ A	0.2 + 0.15	0.5	0.8
2 M Ω	10 μ A	0.5 + 0.5	0.6	1.0
20 M Ω	1 μ A	2.5 + 5	2	3
200 M Ω	100 nA	15 + 50	20	30
2 G Ω	10 nA	200 + 500	200	300

Resistance - Lo Current Mode (Secondary Specifications) ^{[1] [2] [3] [10]}

Range	Measurement Current	Transfer Uncertainty 20 mins ± 1 °C \pm (ppm Reading + ppm Range)	Temperature Coefficient	
			15 °C - 30 °C	5 °C - 15 °C 30 °C - 40 °C
			\pm ppm Reading/°C	
2 Ω	100 mA	2.0 + 2.0	1.5	2.5
20 Ω	10 mA	0.8 + 0.7	0.6	1.0
200 Ω	1 mA	0.8 + 0.7	0.6	1.0
2 k Ω	100 μ A	0.8 + 0.7	0.6	1.0
20 k Ω	10 μ A	0.8 + 0.7	0.6	1.0
200 k Ω	10 μ A	0.5 + 0.5	0.6	1.0
2 M Ω	1 μ A	2.0 + 0.5	2	3
20 M Ω	100 nA	15 + 5	20	30
200 M Ω	10 nA	200 + 500	200	300
2 G Ω	10 nA	200 + 500	200	300

Resistance - High Voltage Mode (Secondary Specifications) ^{[1] [2] [3]}

Range ^[9]	Measurement Current	Transfer Uncertainty 20 mins ± 1 °C \pm (ppm Reading + ppm Range)	Temperature Coefficient	
			15 °C - 30 °C	5 °C - 15 °C 30 °C - 40 °C
			\pm ppm Reading/°C	
20 M Ω	10 μ A	0.5 + 0.5	0.6	1.0
200 M Ω	1 μ A	2.0 + 0.5	2.0	3
2 G Ω	100 nA	15 + 50	20	30
20 G Ω	10 nA	200 + 500	200	300

Type..... True 4-wire with Ohms guard. 2-wire selectable.

Max Lead Resistance..... 10 Ω in any or all leads, 1 Ω on 2 Ω range

Full Scale Measurement Voltage

Normal Mode 200 mV/2 V/20 V

Lo Current Mode 200 mV/2 V

High Voltage Mode 200 V

Protection (All ranges) 250 V rms, 360 V pk

Ratio Accuracy

Range to Range..... \pm (Net Front Input Accuracy + Net Rear Input Accuracy)

Within Range Apply 24 hour or 20 minute Transfer Uncertainty specifications

Settling Time Up to 200 k Ω range generally the same as DC Voltage Filter In but depends on external connections

Temperature

Temperature Readout ^{[1] [2] [3]}

Resistance Range	Absolute Resistance Measurement Uncertainty 365 day Tcal ±1 °C ^[4] ±(ppm Reading + mΩ) ^[11]	Typical Equivalent Temperature Measurement Uncertainty ^[12]			
		Probe Type	Nominal Temperature (°C)	Resistance (Ω)	Accuracy ± (°C)
95% Confidence Level					
0 - 199.990 000 Ω	7.5 + 0.14	25 Ω PRT/SPRT	-200	5	0.0085
		25 Ω PRT/SPRT	0	25	0.0035
		25 Ω PRT/SPRT	660	84	0.0025
		100 Ω PRT/SPRT	-200	20	0.0035
		100 Ω PRT/SPRT	0	100	0.0025
		100 Ω PRT/SPRT	232	185	0.0020
200 - 1999.900 00 Ω	7.5 + 0.5	100 Ω PRT/SPRT	400	250	0.0025
99% Confidence Level					
0 - 199.990 000 Ω	9.5 + 0.18	25 Ω PRT/SPRT	-200	5	0.0010
		25 Ω PRT/SPRT	0	25	0.0040
		25 Ω PRT/SPRT	660	84	0.0025
		100 Ω PRT/SPRT	-200	20	0.0040
		100 Ω PRT/SPRT	0	100	0.0025
		100 Ω PRT/SPRT	232	185	0.0020
200 - 1999.900 00 Ω	9.5 + 0.6	100 Ω PRT/SPRT	400	250	0.0025

Temperature Readout (Secondary Specifications) ^{[1] [2] [3]}

Resistance Range	Resistance Measurement Uncertainty				
	Transfer Uncertainty 20 Minute ±1 °C ±(ppm Reading + mΩ) ^[11]	2-Wire Adder (Ω)	3-Wire Adder (Ω)	Temp Coeff. ± ppm Reading/°C	
				15 °C - 30 °C	5 °C - 15 °C 30 °C - 40 °C
0 - 199.990 000 Ω	0.8 + 0.14	0.1	0.005	0.6	1.0
200 - 1999.900 00 Ω	0.2 + 0.5	0.1	0.005	0.5	0.8

- Type** 4-wire current reversal resistance measurement with readout of equivalent temperature. 2-wire and 3-wire selectable without current reversal. Refer to Resistance specifications for additional details.
- Temperature Range** -200 °C to 660 °C, readout also available in °F or K.
- Linearization** ITS-90 or Callendar van Dusen. Entry and storage of coefficients and nominal resistance for up to 100 probes.
- Current Source** 1 mA

Read Rate and Additional Uncertainty

Read Rate and Additional Uncertainty

Function	Resolution	Filter Frequency (Hz)	Read Rate (readings/second)		Additional Errors ^[13] ± (ppm Reading + ppm Range)	
			Normal	Fast	Normal	Fast
DCV, DCI & Ohms ^[10]	8		1/25	1/6	0 + 0	0 + 0.1
	7		1/6	1/2	0 + 0.1	0 + 0.5
	6		2	35	1.0 + 0.5	0 + 2.5
	5		35	150	0 + 5	0 + 25
ACV & ACI ^[6]	6	1	1/50		0 + 0	
		10	1/5		0 + 0	
		40	1/2		0 + 0	
		100	1		0 + 0	
	5	1	1/50		0 + 5	
		10	1/5		0 + 5	
		40	1/2		0 + 5	
		100	2	0 + 5		
ACV Transfer Off ^[6]		1	1/25		200 + 20	
		10	1/2.5		200 + 20	
		40	1		200 + 20	
		100	4		200 + 20	
PRT & Tru Ohms ^[14]	8	-	1/90	1/30	0 + 0	
	7	-	1/30	1/10	0 + 0.1	
	6	-	1/4	1/3	1.0 + 0.5	
	5	-	1/3	1/3	0 + 5	

Notes to Performance Specifications

Fluke guarantees 8508A performance verification using specifications stated to 99% confidence level.

[1] Specifications apply for max resolution in each function, normal mode

[2] Assumes 4 hour warm-up period

[3] Input zero or offset null required whenever the temperature moves more than ±1 °C from the temperature at which the previous null/zero was performed

[4] TCal = Ambient calibration temperature

[5] Integration time > 1 Power Line cycle

[6] Valid for signals > 1 % Full Scale, Transfer Mode On. Signals must be DC coupled < 40 Hz. Readings invalid with Transfer Mode On and 1Hz filter selected when using internal trigger mode

[7] Max Volt.Hertz 3×10^7

[8] >300 V, < 10 kHz add: $\pm 0.0004 (R-300)^2$ ppm
> 300 V, 10 kHz - 30 kHz add: $\pm (0.0004 + (F - 10000) \times 10^{-7})(R-300)^2$ ppm
> 300 V, > 30 kHz add: $\pm 0.0024 (R-300)^2$ ppm

[9] Typical below 10 Hz for ACV, below 10 Hz and above 10 kHz for ACI, and above 2 GΩ for Resistance

[10] Tru Ohms mode available on 2 Ω to 20 kΩ ranges. Read Rate reduced in Tru Ohms Mode. Specification for Tru Ohms same as corresponding Normal or Lo Current range

[11] Valid for 4-wire sensor

[12] Not including sensor uncertainty

[13] Assume Range and Full Scale = 2000 V when calculating for 1000V Range. For DCI, additional errors only apply in 5 digit resolution

[14] Fast mode not available in PRT

Applying the Specifications

Introduction

The Fluke 8508A has been designed specifically for metrologists. Not only does it provide the performance metrologists need, but it is specified in a way to allow users to really understand the uncertainties of the measurements, and easily make allowance for those uncertainty contributions when performing measurement uncertainty analyses and compiling uncertainty budgets. Contemporary metrology practices, including ISO17025 based laboratory accreditation schemes, require uncertainty analysis to be performed in accordance with the statistically based techniques described in the ISO Guide to the Expression of Uncertainty in Measurement (often referred to as the ‘GUM’). For convenience, the 8508A specifications are quoted at a coverage factor of $k=2$, equivalent to a confidence level of approximately 95 %, as required by these methods. Specifications are also provided at a confidence level of 99 %.

Performance specifications for the 8508A consist of two elements, the first is a contribution expressed as parts-per-million of the Reading, and the second contribution is expressed as parts-per-million of the Range. These must be evaluated and combined for the relevant reading and range values applicable to the measurement being made, ensuring that both elements are evaluated on the same basis, such as parts per million of the measured value or in absolute terms (volts, amps, ohms, etc). The two elements are combined by adding algebraically. For example measuring 10 V on the 20VDC range and applying the 365 day ± 1 °C specifications:

First, expressing the contributions in terms of parts-per-million of the measured value:

$$= \pm \left(3.0 + 0.2 \times \frac{20}{10} \right) = \pm (3.0 + 0.4) = \pm 3.4 \text{ ppm of } 10\text{V}$$

Second, expressing the contributions in volts:

$$= \pm \left(3.0 \times 10^{-6} \times 10 + 0.2 \times 10^{-6} \times 20 \right) = \pm 3.4 \times 10^{-5} = \pm 34 \mu\text{V}$$

The 8508 is designed to provide accuracy and stability without the need for internal auto or self calibration routines which may otherwise compromise the continuity and traceability of measurement performance history. To realise the full potential of the 8508A performance accepted metrology practices should be employed, such as performing a zeroing or null operation to remove any offsets present in the measurement setup when making DC measurements. The 8508A specifications assume that these methods are employed.

Absolute and Relative Specifications

The Relative to Calibration Standards specifications describe the performance of the 8508A itself for the time periods and temperature range listed excluding the uncertainty of the standards used to perform calibration of the 8508A during manufacture. The Absolute specifications include the uncertainty of the standards used to perform calibration of the 8508A at manufacture and may be used to determine the uncertainty of measurements made with the 8508A for periods up to 1 year and over a temperature range of ± 5 °C from calibration. If the user has their 8508A calibrated with different uncertainties, the Relative specifications can be combined with the uncertainties applicable to that calibration to determine the effective absolute uncertainty following that calibration.

Applying User's Calibration Uncertainties

When the 8508A is calibrated by another laboratory the uncertainties of the calibration standards used may be applied by combining those uncertainties with the 8508A's Relative to Standards specifications. The applicable calibration uncertainties and the 8508A relative specifications must both be expressed at the same confidence level, and be combined in a RSS (Root Sum Square) summation. Accepted metrology practice mandates that calibration uncertainties are stated at 95 %. Check the applicable calibration uncertainties are stated at 95 % and then combine them with the 8508A 95% Relative specifications. For example, if the 8508A is calibrated at 10 V DC with an uncertainty of 1.5 ppm at 95 %: The absolute uncertainty at 10 V for a period of 90 days and ± 1 °C from calibration is:

$$= \pm \sqrt{1.5^2 + \left(1.4 + 0.2 \times \frac{20}{10}\right)^2} = \pm 2.3 \text{ ppm of } 10\text{V}$$

Operating and Calibration Temperature Ranges

As a metrology tool, the 8508A will commonly be used in a calibration laboratory where the temperature would be controlled to ± 1 °C, and the 8508A ± 1 °C specifications are applicable to those situations. The majority of electrical calibration laboratories operate at a nominal temperature of 23 °C, the temperature at which the 8508A is calibrated by Fluke during manufacture and service. The 8508A is also capable of being calibrated at any temperature between 20 °C and 25 °C and the ± 1 °C specifications will apply to operation within ± 1 °C of that calibration temperature. In the 8508A specification tables the temperature of calibration is referred to as TCal. Specifications for ± 5 °C are provided for situations where the 8508A is operated in environments with wider temperature variations up to ± 5 °C. For applications where the knowledge of the effect of temperature on 8508A performance is important, temperature coefficients are listed in the 8508A specifications. If the operating temperature is within the range 15 °C to 30 °C the 15 °C to 30 °C temperature coefficient specifications are applicable otherwise use the 5 °C to 15 °C/30 °C to 40 °C figures, provided the temperature lies within that range. The 8508A may be operated at temperatures between 0 °C and 50 °C, but performance is not specified outside the range 5 °C to 40 °C.

Applying Temperature Coefficient Specifications

The 8508A specification tables include information for the typical operating conditions of ± 1 °C for calibration laboratories with tight temperature control, and ± 5 °C for calibration laboratories with looser temperature control or uncontrolled environments within that temperature range. For the majority of applications choosing the Absolute specifications for the most appropriate operating temperature range will be adequate. However performance at other temperatures may be determined by including an allowance for temperature coefficient over the additional temperature range. Care should be taken when making this calculation as an amount of temperature coefficient is already included in the 8508A specifications and those specifications are themselves based on combining contributions using techniques similar to those employed in uncertainty analysis. For example, consider operating at 33 °C, 10 °C from the 23 °C calibration temperature. The ± 5 °C specifications already include a contribution for 5 °C of temperature difference, so this amount of temperature effect must be removed before the effect of the 10 °C difference is added. Consider 10 V on the 20VDC range: 365 day absolute specification (95 %) at 33 °C expressed in parts-per-million of 10 V is:

$$= \pm \sqrt{\left(3.5 + 0.2 \times \frac{20}{10}\right)^2 - (5 \times 0.3)^2 + (10 \times 0.5)^2} = \pm 6.16 \text{ ppm of } 10\text{V}$$

Ratio Measurements

The 8508A Ratio mode will automatically take measurements of inputs applied to the front and rear terminals and display the result as a ratio in the voltage and resistance functions. The measurements can be made on the same range or different ranges. When making measurements on different ranges the error in each measurement is evaluated by applying the relevant specification for each range and combining the two specifications in an RSS summation, expressing the contributions in parts-per-million of the measured values. For example, making measurements of the ratio of 100 mV on the 200mVDC range and 100 V on the 200VDC range, applying the 365 day ± 1 °C Absolute specifications:

$$= \pm \sqrt{\left(4.5 + 0.5 \times \frac{200 \times 10^{-3}}{100 \times 10^{-3}}\right)^2 + \left(4.5 + 0.2 \times \frac{200}{100}\right)^2} = \pm 7.37 \text{ ppm of the ratio}$$

Making measurements on the same range will eliminate range to range errors, such as drift since the time of calibration, and improve the result. When making measurements on the same range these errors will affect both measurements and effectively cancel, leaving short term noise and linearity as the dominant errors. The 20 minute Transfer Uncertainty Specifications are provided to describe the performance obtained when making ratio measurements on the same range. The error in each measurement is evaluated by applying the relevant 20 minute Transfer Uncertainty Specification for each value and combining the two specifications in an RSS summation, expressing the contributions in parts-per-million of the measured values. If the measurements are made within the same range, but independently (not using the ratio mode) with an elapsed time greater than 20 minutes but less than 24 hours between the measurements, then the 24 hour specifications should be applied instead.

For example, making measurements of the ratio of 5 V and 10 V on the 20VDC range, applying the 20 minute Transfer Uncertainty specifications:

$$= \pm \sqrt{\left(0.12 + 0.1 \times \frac{20}{5}\right)^2 + \left(0.12 + 0.1 \times \frac{20}{10}\right)^2} = \pm 0.61 \text{ ppm of the ratio}$$

Additional Errors

The 8508A specifications are listed for the maximum resolution in each function, using the Normal reading mode. For measurements taken in other resolutions or the Fast read mode additional error contributions listed in the Read Rate and Additional Uncertainty table must be included. These additional contributions must be added algebraically to the relevant specifications. For example measuring 10 V on the 20VDC range at 5 digit resolution in Fast mode and applying the 365 day ± 1 °C Absolute specifications:

$$= \pm \left((3.0 + 0) + (0.2 + 25) \times \frac{20}{10} \right) = \pm (3.0 + 50.4) = \pm 53.4 \text{ ppm of 10V}$$

Other additional contributions apply in certain situations and are also to be added algebraically to the relevant specifications. These additional contributions include the DC Accuracy specification to be applied when making DC measurements on the AC Voltage function when DC coupled, and the High Voltage Adder when making measurements above 300 V on the AC Voltage function.

Chapter 6

Calibration and Verification

Title	Page
Introduction.....	6-3
Calibration Overview.....	6-3
Calibration Interval and Performance.....	6-3
Calibration Points.....	6-3
Non-Nominal Values.....	6-4
Enabling Access to Calibration Mode.....	6-4
Calibration Menus.....	6-4
Accessing the Calibration Menus and Calibration Mode.....	6-4
Calibration Menu.....	6-4
SET VALUE Menu.....	6-5
SPOT CAL Menu.....	6-6
SPOT (1 to 6) RMS Menus.....	6-6
SPOT FREQUENCY (1 to 6) Menu.....	6-6
Special Calibration.....	6-7
SPCL Menu.....	6-7
SER # = Menu.....	6-7
Hvlin Menu.....	6-8
Non-volatile input offset compensation.....	6-8
Routine Calibration.....	6-9
Equipment Required for Calibration.....	6-10
Preparing for Calibration.....	6-10
Interconnections.....	6-11
ADC Calibration.....	6-13
DC Voltage Calibration.....	6-13
AC Voltage Calibration.....	6-15
Resistance Calibration.....	6-17
DC Current Calibration.....	6-24
AC Current Calibration.....	6-26
Frequency Calibration.....	6-27
Exit From Calibration Mode and Non-Volatile Input Offset Adjustment.....	6-28
Cal Due Date Entry and Calibration Mode Disable.....	6-29
ACV Spot Frequency Calibration.....	6-29
Performance Verification.....	6-30
Equipment Requirements.....	6-31
Interconnections.....	6-31
Applicable Verification Tolerance and Conditions.....	6-31

Preparation.....	6-32
DC Voltage Checks	6-32
AC Voltage Checks	6-34
Resistance Checks	6-36
DC Current Checks.....	6-39
AC Current Checks.....	6-40
Frequency Checks	6-42

Introduction

Chapter 7 describes the calibration menus, and lists the calibration and performance verification procedures for the 8508A Reference Multimeter. Remote commands for calibration of the 8508A are described in Chapter 4 Remote Operations using the IEEE 488 Interface. In this chapter menu and button selections are shown as all-caps text.

Calibration Overview

The 8508A is calibrated via an electronic autocal feature which allows full calibration of all functions from the front panel (or remotely via the IEEE 488.2 Interface). No hardware adjustments are required.

For each combination of function and range, an appropriate calibration standard (source) is input. At each setting, one keystroke immediately calibrates to the standard by updating an internal non-volatile calibration memory. The instrument automatically determines whether the operation is to be a Zero or Range Gain calibration; or for AC ranges whether it is to be a Zero, LF Gain or HF Gain calibration. As part of the calibration procedure, a non-volatile input-offset compensation is adjusted independently for the front and rear inputs. The autocal process can operate only when the rear panel Calibration switch is in the 'Enable' position. Applying an integrity seal or calibration sticker to prevent access to the rear panel Calibration switch is a convenient way to ensure the security of calibration. When a calibration operation is performed the 8508A internal calibration memory is immediately updated. It is possible to calibrate a single range or single point if the user chooses to do so. However, it is recommended that the calibration procedure listed later in this chapter be followed closely.

Calibration Interval and Performance

It is recommended that the 8508A be calibrated on either a 365-day or 90-day interval depending on the requirements of the applications for which the 8508A is used and the performance specifications required. The performance of the 8508A is specified for periods of 365 days and 90 days – if recalibration takes place on a 90-day cycle use the 90-day specifications for improved performance.

During manufacture, the 8508A is calibrated with low uncertainties, reflected in the Absolute Specifications listed in Chapter 5 Specification section. After recalibration, the user should apply the calibration uncertainties for the calibration standards and for the process applicable to that calibration by combining those calibration uncertainties with the 8508A Relative to Standards specifications, as described in Chapter 5.

Many 8508A owners prefer using Fluke calibration services instead of maintaining their own standards to support their 8508A. To help ensure optimum performance from the 8508A, Fluke offers our calibration service at a variety of worldwide locations. Our worldwide service network provides fast efficient calibration to ensure low uncertainties and optimum accuracy consistent with the original calibration at manufacture.

Calibration Points

There is generally more than one calibration point for each range. An initial measurement (made when the calibration is triggered) determines the intended calibration point. The points for each range and function are listed later in this chapter.

Non-Nominal Values

The Set facility allows the user to set the calibration target to the value of the calibration source available. This facility is most useful when the user's calibration source is not available at the nominal values specified, or when the user has knowledge of the actual output of the calibration source at the required points. In these cases, the use of the Set facility with a table of errors for the calibration source is recommended and will improve the accuracy of the 8508A calibration.

Enabling Access to Calibration Mode

Rear panel calibration switch

The setting of a Calibration-switch on the rear panel enables or restricts access to the calibration mode. Setting the switch to ENABLE allows access to the calibration mode via the front panel CAL key and the CALIBRATION menu, and also enables the remote IEEE 488 interface calibration commands. Setting the switch to DISABLE and applying an integrity seal or calibration sticker to cover the Calibration switch is a convenient way to ensure the security of calibration and to prevent unauthorized access to the switch.

Calibration Menus

Accessing the Calibration Menus and Calibration Mode

Pressing the CAL key on the front panel causes the instrument to respond as follows:

1. Enters the calibration (CAL) mode
2. Displays and allows access to the CALIBRATION menu
3. Displays the CAL legend on the main display

To exit the CALIBRATION menu Press the Quit softkey. On exit the instrument displays the prompt to enter a calibration due date.

When in CAL mode the following front panel keys become inoperative: CLR, TEST, OFFSET, PRT and INPUT. Also the function of the SAMPLE key changes to become the trigger key for initiating a calibration operation.

⚠ Caution

When in CAL mode with the CAL legend appearing on the main display the function of the SAMPLE key is modified from normal operation. If pressed, the SAMPLE key will initiate a calibration operation and permanently alter the instrument calibration state. To avoid accidental mis-calibration do not attempt to operate the instrument in External Trigger mode from the front panel when in Cal, and only press the SAMPLE key when a calibration operation is intended to be performed.

Calibration Menu

This menu allows calibration operations at the calibration point nominal values via Auto, or selection of calibration operations at non-nominal values via Set. It also offers access to the special calibration menu. The CAL legend appears in the left-hand display when in CAL mode.

```
CALIBRATION:  Auto  Set  Special  Quit
```

adj134f.eps

CALIBRATION Menu

This menu defines four *menu* keys:

- Auto** Indicates to the user that the calibration point is automatically set according to the amplitude (and frequency in ACV) of the signal detected. Auto is the default selection on entry to the CALIBRATION menu. Refer to the tables appearing later in this chapter for the calibration points for the selected range. An indication of the use of the SAMPLE key is also displayed
- Set** The Set feature is available in all functions, allowing the user to enter the true value of the calibration standard where it differs from nominal calibration point value. Pressing Set displays the SET VALUE menu except in ACV Spot Frequency mode, when the SPOT CAL menu is displayed. Spot Frequency calibration reduces flatness errors within $\pm 10\%$ of the spot frequency. Set is not available for DCV, DCI, and Resistance range zero calibrations.
- Special** Special Cal is indicated on the main display. The SPCL menu is displayed which allows pre-calibration of the instrument, calibration of the frequency counter, and entry to other calibration utilities.
- Quit** Exits from the CALIBRATION menu via the CALIBRATION DUE ? menu, where the recommended next calibration date can be entered, before finally quitting the calibration mode.

SET VALUE Menu

This menu is obtained by pressing the Set key in the CALIBRATION menu on all functions except ACV Spot Frequency.

```
SET VALUE =                               Enter  Quit
```

adj139f.eps

SET VALUE Menu

When this menu appears, it shows the nominal calibration point value, allowing the user to enter the true output value of the calibration standard at the point to be calibrated. The keyboard is activated, locking out all other keys. The Set value is entered in exponential format expressed in Volts, Amps, or Ohms, and must be above 20% of range (40% on the 1000V DCV and ACV ranges). The SAMPLE key has no effect until the Set value is stored by pressing the Enter key.

The 8508A always chooses the most-recently stored Set value when calibrating. Set is not available for DCV, DCI, and Resistance range zero calibrations.

⚠ Caution

Enter: The new value is stored and the keyboard is de-activated. The set value remains on the dot-matrix display for comparison with the reading on the main display after the SAMPLE key has been pressed.

Quit: Reverts to the CALIBRATION menu, deleting the set value from store.

SPOT CAL Menu

This menu is obtained by pressing the **Set** key in the **CALIBRATION** menu when the 8508A is in **ACV Spot Frequency** mode. It provides a means of calibrating the 8508A at any of six user-specific spot frequencies, at non-nominal calibration values for each ACV range. The 8508A will already be set to an ACV range on entry to the menu.

```
SPOT_CAL:  SP1  SP2  SP3  SP4  SP5  SP6
```

adj140f.eps

SPOT CAL Menu

This menu allows a user to select a spot frequency (**Sp x**) for the selected range. It defines six *menu* keys:

- SP1:** Displays the **SPOT 1 RMS** menu, where users define the RMS value for the Spot Frequency 1 calibration point on the currently selected range.
- SP2-6:** Same as **Sp1** but permitting their own RMS values to be defined.

SPOT (1 to 6) RMS Menus

On entry to one of the six **SPOT** ($x = 1$ to 6) **RMS** menus, the nominal cardinal point value is displayed and the keyboard is activated. A numeric value can be entered that represents the RMS value of the calibration source signal.

```
SPOT n RMS =                               Enter Quit
```

adj141f.eps

SPOT n RMS Menu

- Enter** Stores the displayed RMS value and de-activates the keyboard.
The dot-matrix display moves to the **SPOT FREQUENCY (1 to 6)** menu, showing the calibration signal frequency.
- Quit** Reverts to the **SPOT CAL** menu, not storing any new Spot value.

Note

The **SAMPLE** key is still enabled in the next menu.

SPOT FREQUENCY (1 to 6) Menu

Enter this menu by pressing **Enter** in the **SPOT (1 to 6) RMS** menu, which also stores the RMS value keyed in during this menu. The value in the **SPOT FREQUENCY (1 to 6)** menu is the measured frequency of the present calibration input signal.

```
SPOT FREQUENCY n =                               Quit  
Use SAMPLE to initiate CAL operation
```

adj142f.eps

SPOT FREQUENCY n Menu

Pressing the **SAMPLE** key causes the selected ACV range to be spot-calibrated at the calibration signal frequency. The frequency value is stored and can be viewed from the **UTILITY** menu. Any subsequent measurement on this range whose frequency is within $\pm 10\%$ of the stored frequency is accuracy enhanced by reducing frequency response flatness errors.

Calibrate the spot at a new frequency:

To calibrate the spot at a new frequency, change the input signal to the desired new frequency and press **SAMPLE** as before.

Quit Reverts to the **SPOT CAL** menu with the original Spot calibration intact.

Special Calibration

The **SPCL** menu provides alignment of the main ADC and calibration of the frequency counter.

It also allows the High Voltage Linearity Pre-Calibration to be performed and a section of the Non-Volatile memory to be cleared for test purposes. These facilities are used in the factory for initial pre-calibration processes; they should not require access during the life of the instrument unless repairs have been carried out. They appear here for completeness.

SPCL Menu

The **SPCL** menu appears after pressing the **Spcl** key in the **CALIBRATION** menu. At the same time the instrument is placed in special calibration mode, and the Special **CAL** legend appears on the main display.

When in Special **CAL** mode the following front panel keys remain inoperative: **CLEAR**, **TEST**, **OFFSET**, **PRT** and **INPUT**. Also, the function of the **SAMPLE** key changes to become the trigger key for initiating the **Hvlin** calibration operation.

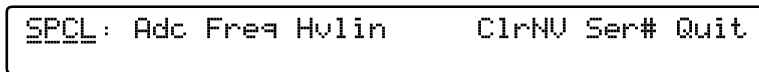

adj137f.eps

SPCL Menu

The **SPCL** menu provides the selection:

- Ser#** Permits entry of the instrument's serial number.
- Adc** Aligns the different resolutions available from the instrument's main analog-to-digital converter, so that there are no significant differences in readings when changing resolutions with a constant input value. No external input signals are required for this calibration. Calibration is initiated directly by making this selection from the **SPCL** menu.
- Freq** Calibrates the frequency counter against an external source. Calibration is initiated directly by making this selection from the **SPCL** menu.
- Hvlin** Selects the sequence required to correct the linearity of the 1kV DC range.
- ClrNV** Provides the capability to clear a section of the non-volatile memory for 'test purposes only'.
- Quit** Reverts to the **CALIBRATION** menu.

SER # = Menu

This menu is obtained by pressing **Ser#** in the **SPCL** menu. On entry to the menu, the most-recently-entered serial number is shown, and the keyboard is activated. A numeric value can be entered.

```
SER# = xxxxxx          Enter Quit
```

adj138f.eps

SER# Menu

The SER# menu provides the selection:

- Enter** Stores the new serial number, de-activates the keyboard, and reverts to the SPCL menu.
- Quit** Reverts to the SPCL menu, leaving the old serial number intact.

Hvlin Menu

This menu sequence is obtained by selecting Hvlin from the SPCL menu. It allows the linearity of the 1kV DC range to be calibrated with the application of five input signals of -1000V, -500V, 0V, +500V and +1000V in turn, with the 1kV DC range selected. On entry to the menu, the user is prompted to apply the first input signal required and step through the sequence:

```
1st signal for Hvlin= -1000      NEXT
Press SAMPLE to measure & save

2nd signal for Hvlin= -500      PREV NEXT
Press SAMPLE to measure & save

3rd signal for Hvlin= 0.0      PREV NEXT
Press SAMPLE to measure & save

4th signal for Hvlin= +500      PREV NEXT
Press SAMPLE to measure & save

5th signal for Hvlin= +1000     PREV CALC
Press SAMPLE to measure & save
```

adj135f.eps

Hvlin Menus

Pressing the SAMPLE key initiates the calibration operation at the signal level displayed for the step in progress and; also, saves the result for calculation of the Hvlin linearity correction factor at the end of the sequence.

- PREV** Moves back to the previous menu allowing the user to repeat the previous step in the sequence if required.
- NEXT** Moves forward through the sequence to the next step and signal level.
- CALC** Initiates calculation and storage of the high voltage linearity correction factor, completing the Hvlin calibration process.

Non-volatile input offset compensation

Good metrology practice should ensure that all high-precision measurements made with the 8508A are preceded by an input zero of each measurement. However, a non-volatile input-offset compensation is independently available for the front and rear inputs and will be used whenever the input zero capability is not in use. The compensation is retained after power down, is unaffected by clearing the volatile input zeros, and is unaffected by range zero calibration adjustments. Compensation is available on all functions, and includes separate compensation of 2-wire and 4-wire measurements in the resistance functions.

Non-volatile input-offset compensation adjustment is available only when the rear panel calibration keyswitch is in the ENABLE position and the CAL legend is not shown on the main display.

Adjustment is performed by initiating an input zero operation with the 8508A in this condition, using the INPUT menu as described in Chapter 3 or using the IEEE 488 input zeroing commands described in Chapter 4. Apply a high-integrity low-thermal emf 4-wire short to the input terminals for this operation. Following adjustment for a particular combination of function, range, and input a compensation is also stored for the corresponding volatile input zero, and the Zero legend is shown on the main display. The Zero legend may be removed from the display without affecting the stored non-volatile compensation by using one of the following operations:

1. Power the instrument down.
2. Press the CLEAR key and make any of the selections from the CLEAR menu.
3. Press the CAL key and entering CAL mode.
4. Use the corresponding IEEE 488 commands.

Routine Calibration

The 8508A is a Digital Reference Multimeter offering state-of-the-art performance. This procedure is intended as a guide for qualified metrology personnel who have access to a standards laboratory with equipment available to support an instrument of this level of accuracy. It reflects the calibration process used by Fluke to perform 8508A calibration implemented in an automated system, but as a manual procedure for users to follow. The procedure is based on the following assumptions:

1. Users are familiar with relevant best measurement practice.
2. Users will take precautions to avoid introducing errors from sources such as thermal emfs, leakages, electromagnetic interference, etc.
3. Users will make adequate allowance for equipment stabilization and measurement settling times.

This routine calibration procedure describes the calibration points and sequence of operations required to calibrate the 8508A and assumes calibration references of adequate traceable uncertainty are available – in this case a Fluke 5720A calibrator and 5725A amplifier used with an 8508A-7000 Calibration Kit. The procedure assumes the user is able to calibrate and characterize the calibration standards, without describing the process required to do so.

Characterization of the 5720A/5725A combination allows the 8508 to be calibrated with uncertainties lower than otherwise available from that equipment. The characterization process determines the 5720A/5725A errors from nominal at the values required for 8508A calibration, and may be performed using Fluke’s recommended verification procedures appearing in the 5700A/5720A Service Manual as a guide. If a characterized 5720A/5725A combination is available where the error from nominal at the various points required is known, those errors may be taken into account during 8508A calibration to reduce the uncertainties. The errors may be determined by measurement against suitable standards or may be taken from an applicable certificate of calibration. The uncertainty of the characterized calibrator should be combined with the 8508A Relative to Standards specifications to determine 8508A performance after calibration. (RSS summation is recommended).

If the calibrator is not characterized to determine its errors from nominal, its output should be assumed to be nominal at all points. Its performance specifications should be

used to provide calibration uncertainties to be combined with the 8508A Relative to Standards specifications to determine the achieved 8508A performance after calibration. (RSS summation is recommended).

See Chapter 5 for more details of combining 8508A Relative to Standards specifications and calibration uncertainties.

Note

The instrument should be thoroughly checked to ensure it is operating correctly before attempting calibration. A performance verification procedure appears later in this section.

Equipment Required for Calibration

The equipment required for Calibration and Performance Verification is listed in Table 6-1.

Table 6-1. Required Equipment for Calibration and Performance Verification

Equipment Required
Fluke 5720A Multifunction Calibrator ^{1,2}
Fluke 5725A Amplifier ²
Fluke 8508A-7000K Calibration kit comprising 1 GΩ Standard, two precision low thermal emf 4-wire short devices, and connecting leads.
<ol style="list-style-type: none"> 1. Availability of a 1 MHz frequency reference signal may be required for 5720A frequency locking during 8508A frequency calibration procedure. 2. Best uncertainties are obtained by characterizing the outputs of the 5720A and 5725A at the points used for 8508A calibration.

Alternate equipment may be used, but users should ensure it provides adequate calibration uncertainties. Performance of the 8508A after calibration should be determined by combining the applicable calibration uncertainties provided by the calibration equipment with the 8508A Relative to Standards specifications. (RSS summation is recommended).

Preparing for Calibration

The following procedures represent the recommended order of calibration, giving all the necessary setup commands.

1. Allow the instrument to warm-up under power in the specified environment for at least 4 hours.
2. Press the CLEAR key, select Pwr Up Dflt to restore the power up default configuration and display the DCV menu.
3. Set the rear panel Calibration switch to Enable. Removal of any calibration sticker or integrity seal covering the calibration switch will be necessary.
4. Press the CAL key.
5. The CALIBRATION menu is displayed.

The calibration menu appears, and the CAL legend appears on the main display. When entering CAL mode and selecting a function the optimum resolution for performing calibration in that function is automatically selected.

Note

It is recommended that the default resolutions are used for calibration purposes. Other resolutions may be selected and calibration operations performed, but accuracy of calibration will be degraded if calibration is performed in lower resolutions.

⚠ Caution

When in CAL mode with the CAL legend appearing on the main display, the function of the SAMPLE key is modified from normal operation. If pressed, the SAMPLE key will initiate a calibration operation and permanently alter the instrument calibration state. To avoid accidental mis-calibration do not attempt to operate the instrument in External Trigger mode from the front panel when in Cal, and only press the SAMPLE key when a calibration operation is intended to be performed.

Table 6-2. Calibration Sequence

General Sequence for Full Instrument Calibration ¹	
Enable Calibration Enter Cal mode	Set rear panel calibration switch to ENABLE. Access CALIBRATION menu .
Adc Cal	Analog to digital converter alignment. Performed only if required.
DCV	Range Zeros and Range Gains (200 mV to 1 kV Ranges).
ACV	Range Zeros, Range LF Gains and Range HF Gains (200 mV to 1 kV Ranges).
Ohms	Range Zeros and Range Gains: Ohms: 2 Ω to 2 GΩ Ranges, then LoI Ohms. TruΩ: 2 Ω to 20kΩ Ranges, then LoI TruΩ. HiVΩ: 20 MΩ to 20 GΩ Ranges.
DCI	Range Zeros and Range Gains (200μA to 20A Ranges).
ACI	Range Zeros and Range Gains (200μA to 20A Ranges).
Frequency	Frequency counter cal at 1MHz
Exit Cal mode NV input offsets	Quit the CALIBRATION menu. Front & rear non-volatile input offset adjustments: DCV, Ohms, TruΩ, HiVΩ (including LoI , 2 & 4-wire).
Set CAL DUE	Set the date for the next external calibration
Disable Calibration	Set rear panel calibration switch to DISABLE.
1. To meet user's need, just one range on one function can be calibrated.	

Interconnections

The Fluke 8508A-7000K Calibration kit contains a specially designed lead set which connects directly to the terminals of the 8508A, the 5720A, and the 5725A for the purpose of 8508A calibration. It is recommended that this lead kit be used to avoid introducing measurement errors due to interconnections and to duplicate the configuration used by Fluke for 8508A calibration. Figure 6-1 shows the interconnections used in detail. If alternate leads are substituted, make sure they are metrology grade leads, and of adequate voltage and current ratings. Leads should be kept as short as possible, constructed from low capacitance low leakage dielectric material (PTFE) with low thermal emf terminations, and exactly duplicate the configuration and interconnections shown.

When calibrating the 2GΩ and 20GΩ resistance ranges the 1GΩ standard resistor supplied in the Fluke 8508A-7000K Calibration kit plugs directly into the 8508A front input terminals, without any interconnecting leads. If alternate resistance standards are used for resistance calibration, refer to the resistance-measurements section of Chapter 3 *Making Measurements* for connection details.

The Fluke 8508A-7000K Calibration kit also contains two precision low-thermal emf 4-wire shorting devices for use when performing the non-volatile input offset adjustments at the front and rear input terminals. These devices link the input terminals in the following order: Input Lo to Input Hi to Sense Hi to Sense Lo. If these devices are not available it is recommended that a U-shaped piece of thick bare copper wire be used to link the terminals in the same manner.

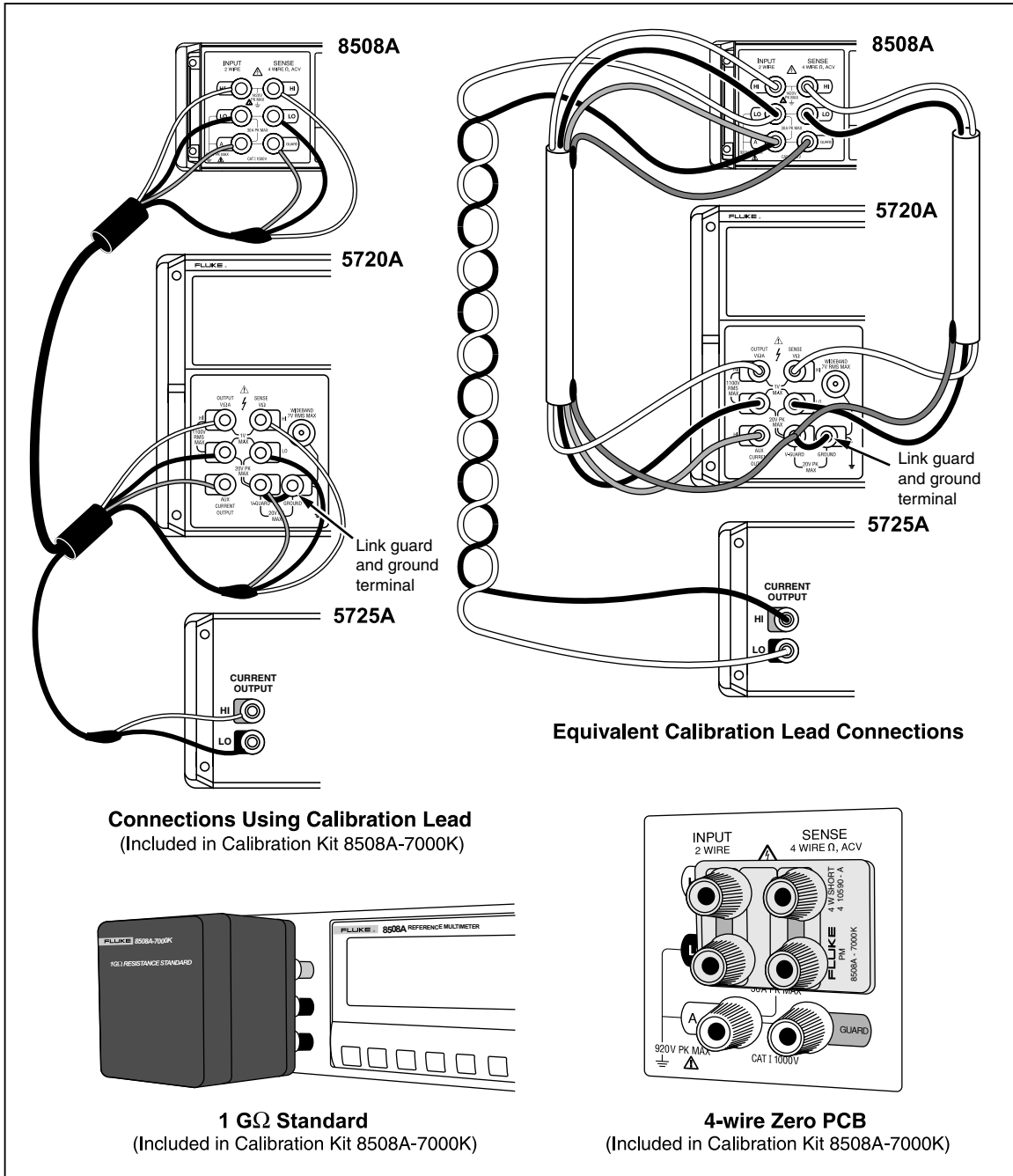

Figure 6-1. Equipment Connections Required for Calibration

adj381f.eps

ADC Calibration

ADC (analog to digital converter) calibration aligns the different resolutions available from the 8508A analog to digital converter, so that there are no significant differences in readings when changing resolutions with a constant input value. It is recommended that ADC CAL is only performed if performance verification indicates significant resolution differences. If required, it is recommended that ADC calibration is performed before any other calibrations.

No external equipment or signals are required to perform ADC calibration.

Procedure

1. Ensure that no signals are present on the 8508A inputs. The 8508A may be left connected to the calibrator as shown above provided the calibrator output is set to STANDBY.
2. On the 8508A, Press CAL to enter the CALIBRATION menu, and select SPCL.
3. Select Adc to initiate the calibration operation, which will take approximately 3 minutes to complete.

Calibration is complete when the Busy legend goes out.

DC Voltage Calibration

⚠⚠ Warning

The calibrator can deliver a lethal electric shock.

To avoid electric shock when performing the following calibration procedures:

- **Never touch any lead or terminal unless you are absolutely certain that no dangerous voltage is present.**
- **Make sure that signal leads are in a safe condition before you handle them in any way.**

Initial Setup

1. Press the DCV key, select the 200 mV range.
2. Press the CONFIG key. Select Filt.
3. In calibration mode the resolution defaults to RESL7 in the DCV function. It is recommended that this resolution is used for calibration of all DCV ranges.
4. Reselect DCV.
5. Confirm that the 8508A is configured for internal guard (External Guard is deselected) by checking that the Ext Grd legend does not appear on the left-hand display.
6. Ensure that the calibrator output is set to STANDBY and configured for Internal Guard (EXT GRD is deselected).
7. Connect the Calibrator to the 8508A as shown above.

Range Zero and Gain Calibration Procedure

After the initial setup and connecting up, use the following procedure to calibrate range zero, then positive and negative range gains on all DCV ranges. Just one range can be calibrated if required, but for a full calibration start with the 200 mV range and work up to the 1kV range, as shown in Table 6-3.

Table 6-3. DC Voltage Calibration Points and Sequence

8508A Range	Point	Voltage
200 mV	Zero	0 mV
	Range Gain +ve	+100 mV
	Range Gain -ve	-100 mV
2 V	Zero	0 V
	Range Gain +ve	+1 V
	Range Gain -ve	-1 V
20 V	Zero	0 V
	Range Gain +ve	+10 V
	Range Gain -ve	-10 V
200 V	Zero	0 V
	Range Gain +ve	+100 V
	Range Gain -ve	-100 V
1000 V	Zero	0 V
	Range Gain +ve	+1000 V
	Range Gain -ve	-1000 V

The procedure assumes the user has knowledge of the actual output value of the calibrator at the range gain values, from a measurement or from a certificate of calibration. The Set feature allows a user to enter the true output value of the calibration standard where it differs from the nominal range gain point. If the calibrator output is considered to be exactly nominal, use of the Set feature is not required, also **omit** steps 2-4 for the Range Gain Points.

On each range, the 8508A automatically recognizes the appropriate value as range zero or range gain from the applied signal amplitude and polarity.

Zero Point

1. On the 8508A, select the required range.
2. On the Calibrator, set zero output and Operate.
3. On the 8508A, press CAL to enter the CALIBRATION menu.
4. Press SAMPLE to initiate the calibration operation.

Calibration is complete when the Busy legend goes out and the calibrated measurement is displayed.

Range Gain Points

1. On the Calibrator, select the positive Range Gain point Output value.
2. On the 8508A, Press CAL to revert to CALIBRATION menu.
3. Select Set on the CALIBRATION menu.
4. Use the numeric keys with the SET VALUE menu to key in the true output value of the calibrator at the range gain value, then press Enter.
5. Press SAMPLE to initiate the calibration operation.
Calibration is complete when the Busy legend goes out and the calibrated measurement is displayed.
6. On the Calibrator, select the negative Range Gain point Output value.
7. Repeat steps 3 to 5 above to calibrate the negative Range gain point.
8. On the Calibrator, set Standby.
9. Press the DCV key to revert to the ranges menu.

AC Voltage Calibration

⚠ ⚠ Warning

The Calibrator can deliver a lethal electric shock.

To avoid electric shock when performing the following calibration procedures:

- **Never touch any lead or terminal unless you are absolutely certain that no dangerous voltage is present.**
- **Make sure that signal leads are in a safe condition before you handle them in any way**

Initial Setup and Connections

1. Press the ACV key, select the 200 mV range..
2. Press the CONFIG key. In calibration mode in the ACV function Transfer mode defaults to On for enhanced performance, resolution defaults to RESL6, and the 100Hz RMS filter is automatically selected. It is recommended that this resolution, Transfer On and 100Hz Filter is used for calibration of all ACV ranges.
3. Reselect ACV.
4. Confirm that the 8508A is configured for internal guard (External Guard is deselected) by checking that the Ext Grd legend does not appear on the left-hand display.
5. Ensure that the calibrator output is set to STANDBY and configured for Internal Guard (EXT GRD is deselected).
6. Connect the Calibrator to the 8508A as shown above.

Range Zero, LF, and HF Gain Calibration Procedure (not in Spot Frequency mode)

Using the following procedure to calibrate range zero then range LF and HF gains on all ACV ranges at the voltages and frequencies detailed in Table 6-4. Just one range can be calibrated if required, but for a full-calibration start with the 200 mV range and work up to the 1kV range.

Table 6-4. AC Voltage Calibration Points and Sequence

8508A Range	Point	Voltage	Frequency
200 mV	Zero (5 % Range)	10 mV	1 kHz
	Range Gain LF	100 mV	1 kHz
	Range Gain HF	100 mV	60 kHz
2 V	Zero (0.5 % Range)	10 mV	1 kHz
	Range Gain LF	1V	1 kHz
	Range Gain HF	1V	60 kHz
20 V	Zero (0.5 % Range)	100 mV	1 kHz
	Range Gain LF	10 V	1 kHz
	Range Gain HF	10 V	60 kHz
200 V	Zero (0.5 % Range)	1 V	1 kHz
	Range Gain LF	100 V	1 kHz
	Range Gain HF	100 V	60 kHz
1000 V ¹	Zero (0.5 % Range)	5 V	1 kHz
	Range Gain LF	500 V	1 kHz
	Range Gain HF	500 V	30 kHz

1. 1000V range Gain calibrations may be performed at voltages above 500V. The 1000V range Gain and Zero calibrations should be performed together, with the Zero cal performed at 1% of the nominal value used for Gain cal.

The procedure assumes the user has knowledge of the actual output value of the calibrator at each point, from a measurement or from a certificate of calibration. The **Set** feature allows a user to enter the true output value of the calibration standard where it differs from the nominal point. If the calibrator output is considered to be exactly nominal, use of the **Set** feature is not required when calibrating at full range, also **omit** steps 3-5. Calibrating the 1000V range at the recommended 500V requires a Set Value of 500 before the Zero cal.

On each range, the 8508A automatically recognizes the appropriate value as range zero from the applied signal amplitude, and automatically recognizes the range LF and HF gain points from the applied signal frequency.

1. On the 8508A, select the required Range.
2. On the Calibrator select Output Voltage and Frequency, Operate
3. On the 8508A, Press CAL to revert to CALIBRATION menu.
4. Select Set on the CALIBRATION menu.
5. Use the numeric keys with the SET VALUE menu to key in the true output value of the calibrator, then press Enter.
6. Press SAMPLE to initiate the calibration operation.

Calibration is complete when the Busy legend goes out and the calibrated measurement is displayed Note that HF gain calibrations are iterative, and repeating the HF calibration may improve the result.

7. On the Calibrator, set Output to STANDBY.
8. On the 8508A, press ACV key to revert to the ranges menu.

Resistance Calibration

When calibrating the resistance function, each of the resistance modes (Normal, LoI, TruΩ, TruΩ LoI and HiVΩ) must be individually calibrated. The following procedure assumes use of a multifunction calibrator and calibrates each resistance mode in turn, range by range. If individual standard resistors are used it may be more convenient to calibrate all the modes in turn for each resistance value to avoid connecting the same resistance standard several times during the calibration sequence. A 1GΩ standard resistor provided in the 8508A-7000K calibration kit is used for ranges above 200MΩ as the highest resistance available from the 5720A calibrator is 100MΩ.

Table 6-5. Resistance Calibration Points and Sequence

8508A Range	Modes	Point	Resistance
2 Ω	Normal, Normal LoI, TruΩ, TruΩ LoI	Zero	0 Ω
		Range Gain	1 Ω
20 Ω	Normal, Normal LoI, TruΩ, TruΩ LoI	Zero	0 Ω
		Range Gain	10 Ω
200 Ω	Normal, Normal LoI, TruΩ, TruΩ LoI	Zero	0 Ω
		Range Gain	100 Ω
2 kΩ	Normal, Normal LoI, TruΩ, TruΩ LoI	Zero	0 Ω
		Range Gain	1 kΩ
20 kΩ	Normal, Normal LoI, TruΩ, TruΩ LoI	Zero	0 Ω
		Range Gain	10 kΩ
200 kΩ	Normal, Normal LoI	Zero	0 Ω
		Range Gain	100 kΩ
2 MΩ	Normal, Normal LoI	Zero	0 Ω
		Range Gain	1 MΩ
20 MΩ	Normal, Normal LoI, HiVΩ	Zero	0 Ω
		Range Gain	10 MΩ
200 MΩ	Normal, Normal LoI, HiVΩ	Zero	0 Ω
		Range Gain	100 MΩ
2 GΩ	Normal, Normal LoI, HiVΩ	Zero	0 Ω
		Range Gain	1 GΩ
20 GΩ	HiVΩ	Zero	0 Ω
		Range Gain	Optional ¹
1. 20 GΩ range gain is calibrated automatically during 2 GΩ HiVΩ range gain cal, but may be calibrated separately (after 2GΩ HiVΩ range cal) at 10 GΩ if a standard is available. The 100 MΩ and 2 GΩ NormalΩ ranges must be calibrated before 2 GΩ HiVΩ range gain point.			

Initial Setup and Connections

1. Press the Ω key and select the 200 Ω range.
2. Press the CONFIG key and select Filt and 4w Ω .
3. In calibration mode the resolution defaults to RESL7 in the resistance function. It is recommended that this resolution is used for calibration of all resistance ranges.
4. Reselect Ω .
5. Confirm that the 8508A is configured for internal guard (External Guard is deselected) by checking that the Ext Grd legend does not appear on the left-hand display.
6. Ensure that the calibrator output is set to STANDBY and configured for Internal Guard (EXT GRD is deselected). On the calibrator select EX SNS (4-wire).
7. Connect the Calibrator to the 8508A as shown above.
8. If using standard resistors in place of the calibrator refer to "Measuring Resistance" in Chapter 3 for information regarding 4-wire resistance connections.

Normal Ω Mode Calibration

1. Press the Ω key and select the 2 Ω range.
2. Press the CONFIG key and select Filt and 4w Ω . Ensure LoI is deselected.

Range Zero and Gain Calibration Procedure

After the initial setup and connecting up, use the following procedure to calibrate range zero and range gain for the ranges and points detailed in Table 6-5 for the Normal Ω mode. For the 2G Ω range use the 1G Ω standard resistor in place of the calibrator. Just one range can be calibrated if required, but for a full-calibration start with the 2 Ω range and work up to the 2G Ω range.

Note that EX SNS (4-wire) is not available on the 5720A 100M Ω range, and the 8508-7000K 1G Ω standard resistor is used as a 2-wire device with the calibrator 2-wire resistance zero used for the corresponding zero points. 4W Ω is deselected on the 8508A when calibrating the 200 M Ω and 2G Ω range, range zero, and range gain points.

On each range, the 8508A automatically recognizes the appropriate value as range zero or range gain from the applied resistance value.

Note

It is unlikely that the resistance standard will be at exactly the nominal value required. The Set feature allows a user to enter the true output value of the calibration standard where it differs from nominal range gain point. If the resistance value is exactly the nominal value required, omit steps 2-4 for the Range Gain Point.

Zero Point

1. On the 8508A, select the required range.
2. On the Calibrator, select zero and Operate. Alternatively if using a standard resistor connect the standard resistor for a 4-wire resistance zero. (For the 200M Ω and 2G Ω ranges, de-select EX SNS on the calibrator and de-select 4W Ω on the 8508A.)
3. On the 8508A, press CAL to enter the CALIBRATION menu.
4. Press SAMPLE to initiate the calibration operation.

Calibration is complete when the Busy legend goes out and the calibrated measurement is displayed

Range Gain Point

1. On the Calibrator, select the Range Gain point resistance value. Alternatively if using a standard resistor re-connect the standard resistor to measure its resistance. (For the 2G Ω range the 8508-7000K 1G Ω standard resistor is used in place of the calibrator. For the 200M Ω and 2G Ω ranges, de-select EX SNS on the calibrator and de-select 4W Ω on the 8508A.)
2. On the 8508A, Press CAL to revert to CALIBRATION menu.
3. Select Set on the CALIBRATION menu.
4. Use the numeric keys with the SET VALUE menu to key in the true output value of the calibrator (or the value of the resistance standard) at the range gain value, then press Enter.
5. Press SAMPLE to initiate the calibration operation.
Calibration is complete when the Busy legend goes out and the calibrated measurement is displayed.
6. On the Calibrator, set STANDBY.
7. Press the Ω key to revert to the ranges menu.

LoI Ω Mode Calibration

1. Press the Ω key and select the 2 Ω range.
2. Press the CONFIG key and select Filt, LoI and 4w Ω .

Range Zero and Gain Calibration Procedure

After the initial setup and connecting up, use the following procedure to calibrate range zero and range gain for the ranges and points detailed in Table 6-5 for the LoI mode. For the 2G Ω range use the 1G Ω standard resistor in place of the calibrator. Just one range can be calibrated, if required, but for a full-calibration start with the 2 Ω range and work up to the 2G Ω range.

Note that EX SNS (4-wire) is not available on the 5720A 100M Ω range, and the 8508-7000K 1G Ω standard resistor is used as a 2-wire device with the calibrator 2-wire resistance zero used for the corresponding zero points. 4W Ω is deselected on the 8508A when calibrating the 200 M Ω and 2G Ω range, range zero, and range gain points.

On each range, the 8508A automatically recognizes the appropriate value as range zero or range gain from the applied resistance value.

Note

It is unlikely that the resistance standard will be at exactly the nominal value required. The Set feature allows a user to enter the true output value of the calibration standard where it differs from nominal range gain point. If the resistance value is exactly the nominal value required, omit steps 2-4 for the Range Gain Point.

Zero Point

1. On the 8508A, select the required range.
2. On the Calibrator, select zero Ω and Operate. Alternatively if using a standard resistor connect the standard resistor for a 4-wire resistance zero. (For the 200M Ω and 2G Ω ranges, de-select Ex SNS on the calibrator and de-select 4W Ω on the 8508A.)
3. On the 8508A, press CAL to enter the CALIBRATION menu.
4. Press SAMPLE to initiate the calibration operation.
Calibration is complete when the Busy legend goes out and the calibrated measurement is displayed.

Range Gain Point

1. On the Calibrator, select the Range Gain point resistance value. Alternatively if using a standard resistor re-connect the standard resistor to measure its resistance. (For the 2G Ω range the 8508-7000K 1G Ω standard resistor is used in place of the calibrator. For the 200M Ω and 2G Ω ranges, de-select Ex SNS on the calibrator and de-select 4W Ω on the 8508A.)
2. On the 8508A, Press CAL to revert to CALIBRATION menu.
3. Select Set on the CALIBRATION menu.
4. Use the numeric keys with the SET VALUE menu to key in the true output value of the calibrator (or the value of the resistance standard) at the range gain value, then press Enter.
5. Press SAMPLE.
Calibration is complete when the Busy legend goes out and the calibrated measurement is displayed.
6. On the Calibrator, set STANDBY.
7. Press the Ω key to revert to the ranges menu.

Tru Ω Mode Calibration

1. Press the Ω Plus key and select Tru Ω . From the Tru Ω menu select the 2 Ω range.
2. Press the CONFIG key and select Filt and 4w Ω . Ensure Lol is deselected.

Range Zero and Gain Calibration Procedure

After the initial setup and connecting up, use the following procedure to calibrate range zero and range gain for the ranges and points detailed in Table 6-5 for the Tru Ω mode. Just one range can be calibrated, if required, but for a full-calibration start with the 2 Ω range and work up to the 20k Ω range.

On each range, the 8508A automatically recognizes the appropriate value as range zero or range gain from the applied resistance value.

Note

It is unlikely that the resistance standard will be at exactly the nominal value required. The Set feature allows a user to enter the true output value of the calibration standard where it differs from nominal range gain point. If the resistance value is exactly the nominal value required, omit steps 2-4 for the Range Gain Point.

Zero Point

1. On the 8508A, select the required range.
2. On the Calibrator, select zero Ω and Operate. Alternatively if using a standard resistor connect the standard resistor for a 4-wire resistance zero.
3. On the 8508A, press CAL to enter the CALIBRATION menu.
4. Press SAMPLE to initiate the calibration operation.
Calibration is complete when the Busy legend goes out and the calibrated measurement is displayed.

Range Gain Point

1. On the Calibrator, select Range Gain point Output value. Alternatively if using a standard resistor re-connect the standard resistor to measure its resistance.
2. On the 8508A, Press CAL to revert to CALIBRATION menu.
3. Select Set on the CALIBRATION menu.
4. Use the numeric keys with the SET VALUE menu to key in the true output value of the calibrator (or the value of the resistance standard) at the range gain value, then press Enter.
5. Press SAMPLE to initiate the calibration operation.
Calibration is complete when the Busy legend goes out and the calibrated measurement is displayed.
6. On the Calibrator, set STANDBY.
7. Press the Ω key to revert to the ranges menu.

Tru Ω LoI Mode Calibration

1. Press the Ω Plus key and select Tru Ω . From the Tru Ω menu select the 2 Ω range.
2. Press the CONFIG key and select Filt, LoI and 4w Ω .

Range Zero and Gain Calibration Procedure

After the initial setup and connecting up, use the following procedure to calibrate range zero and range gain for the ranges and points detailed in Table 6-5 for the Tru Ω LoI mode. Just one range can be calibrated if required, but for a full calibration start with the 2 Ω range and work up to the 20k Ω range.

On each range, the 8508A automatically recognizes the appropriate value as range zero or range gain from the applied resistance value.

Note

It is unlikely that the resistance standard will be at exactly the nominal value required. The Set feature allows a user to enter the true output value of the calibration standard where it differs from nominal range gain point. If the resistance value is exactly the nominal value required, omit steps 2-4 for the Range Gain Point.

Zero Point

1. On the 8508A, select the required range.
2. On the Calibrator, select zero Ω and Operate. Alternatively if using a standard resistor connect the standard resistor for a 4-wire resistance zero.
3. On the 8508A, press CAL to enter the CALIBRATION menu.
4. Press SAMPLE to initiate the calibration operation.
Calibration is complete when the Busy legend goes out and the calibrated measurement is displayed.

Range Gain Point

1. On the Calibrator, select Range Gain point Output value. Alternatively if using a standard resistor re-connect the standard resistor to measure its resistance.
2. On the 8508A, Press CAL to revert to CALIBRATION menu.
3. Select Set on the CALIBRATION menu.
4. Use the numeric keys with the SET VALUE menu to key in the true output value of the calibrator (or the value of the resistance standard) at the range gain value, then press Enter.
5. Press SAMPLE to initiate the calibration operation.
Calibration is complete when the Busy legend goes out and the calibrated measurement is displayed.
6. On the Calibrator, set STANDBY.
7. Press the Ω key to revert to the ranges menu.

HiV Ω Mode Calibration

⚠ ⚠ Warning

The 8508A can deliver a lethal electric shock when operating in the High Voltage Resistance mode. Voltages up to 240V may appear on the terminals.

To avoid electric shock when performing the following calibration procedures:

- **Never touch any lead or terminal unless you are absolutely certain that no dangerous voltage is present.**
 - **Make sure that signal leads are in a safe condition before you handle them in any way.**
1. Press the Ω Plus key and select HiV Ω . From the HiV Ω menu select the 20M Ω range.
 2. Press the CONFIG key and select Filt and 4w Ω .

Range Zero and Gain Calibration Procedure

After the initial setup and connecting up, use the following procedure to calibrate range zero and range gain for the ranges and points detailed in Table 6-5 for the HiV Ω mode. Just one range can be calibrated if required, but for a full calibration start with the 20M Ω range and work up to the 20G Ω range.

For the 2G Ω range use the 1G Ω standard resistor in place of the calibrator. To avoid the requirement for a 10G Ω standard, the 20G Ω range is automatically calibrated when the 2G Ω range gain calibration is triggered. It is also necessary for the 100 M Ω and 1G Ω Normal Ω ranges to be calibrated prior to the 2G Ω HiV Ω range for the result to be valid. A 10G Ω standard resistor may be used for calibrating the 20G Ω range if available, but if performed, this operation must take place after the 2G Ω range gain point calibration to avoid the automatic process overwriting the result.

Voltages of approximately 200V will be developed across the resistance standard at full scale, ensure the resistance standards used are suitable for operation at these voltages.

Note that EX SNS (4-wire) is not available on the 5720A 100M Ω range, and the 8508-7000K 1G Ω standard resistor is used as a 2-wire device with the calibrator 2-wire resistance zero used for the corresponding zero points. 4W Ω is deselected on the 8508A when calibrating the 200 M Ω and 2G Ω range, range zero, and range gain points.

On each range, the 8508A automatically recognizes the appropriate value as range zero or range gain from the applied resistance value.

Note

*It is unlikely that the resistance standard will be at exactly the nominal value required. The **Set** feature allows a user to enter the true output value of the calibration standard where it differs from nominal range gain point. If the resistance value is exactly the nominal value required, **omit** steps 2-4 for the Range Gain Point .*

Zero Point

1. On the 8508A, select the required range.
2. On the Calibrator, select zero Ω and Operate. (For the 200M Ω range and above, de-select Ex SNS on the calibrator and de-select 4W Ω on the 8508A.) Alternatively if using a standard resistor connect the standard resistor for a 4-wire resistance zero.
3. On the 8508A, press CAL to enter the CALIBRATION menu.
4. Press SAMPLE to initiate the calibration operation.

Calibration is complete when the Busy legend goes out and the calibrated measurement is displayed.

Range Gain Point

1. On the Calibrator, select Range Gain point Output value. Alternatively if using a standard resistor re-connect the standard resistor to measure its resistance. (For the 2G Ω range the 8508-7000K 1G Ω standard resistor is used in place of the calibrator. For the 200M Ω range and above, de-select Ex SNS on the calibrator and de-select 4W Ω on the 8508A. Calibration of the 20G Ω range gain point takes place automatically when calibrating 2G Ω range, and calibration against an external standard is optional if a suitable standard is available).
2. On the 8508A, Press CAL to revert to CALIBRATION menu.
3. Select Set on the CALIBRATION menu.
4. Use the numeric keys with the SET VALUE menu to key in the true output value of the calibrator (or the value of the resistance standard) at the range gain value, then press Enter.

5. Press **SAMPLE** to initiate the calibration operation.
Calibration is complete when the Busy legend goes out and the calibrated measurement is displayed.
6. On the Calibrator, set **STANDBY**.
7. Press the Ω key to revert to the ranges menu.

DC Current Calibration

⚠ ⚠ Warning

The calibrator can deliver a lethal electric shock.

To avoid electric shock when performing the following calibration procedures:

- **Never touch any lead or terminal unless you are absolutely certain that no dangerous voltage is present.**
- **Make sure that signal leads are in a safe condition before you handle them in any way.**

Initial Setup

1. Press the **DCI** key, select the 200 μ A range.
2. Press the **CONFIG** key. Select **Filt**.
3. In calibration mode the resolution defaults to **RESL7** in the **DCI** function. It is recommended that this resolution is used for calibration of all **DCI** ranges.
4. Reselect **DCI**.
5. Confirm that the 8508A is configured for internal guard (External Guard is deselected) by checking that the **Ext Grd** legend does not appear on the left-hand display.
6. Ensure that the calibrator output is set to **STANDBY** and configured for Internal Guard (**EXT GRD** is deselected).
7. Connect the Calibrator to the 8508A as shown above.

Range Zero and Gain Calibration Procedure

After the initial setup and connecting up, use the following procedure to calibrate range zero, then positive and negative range gains on all **DCI** ranges. Just one range can be calibrated if required, but for a full calibration start with the 200 μ A range and work up to the 20A range, as shown in Table 6-6.

Table 6-6. DC Current Calibration Points and Sequence

8508A Range	Point	Current
200 μ A	Zero	0 μ A
	Range Gain +ve	+100 μ A
	Range Gain -ve	-100 μ A
2 mA	Zero	0 mA
	Range Gain +ve	+1 mA
	Range Gain -ve	-1 mA
20 mA	Zero	0 mA
	Range Gain +ve	+10 mA
	Range Gain -ve	-10 mA
200 mA	Zero	0 mA
	Range Gain +ve	+100 mA
	Range Gain -ve	-100 mA
2 A	Zero	0 A
	Range Gain +ve	+1 A
	Range Gain -ve	-1 A
20 A	Zero	0 A
	Range Gain +ve	+10 A
	Range Gain -ve	-10 A

The procedure assumes the user has knowledge of the actual output value of the calibrator at the range gain values, from a measurement or from a certificate of calibration. The Set feature allows a user to enter the true output value of the calibration standard where it differs from the nominal range gain point. If the calibrator output is considered to be exactly nominal, use of the Set feature is not required, also **omit** steps 2-4 for the Range Gain Points.

On each range, the 8508A automatically recognizes the appropriate value as range zero or range gain from the applied signal amplitude and polarity.

Zero Point

1. On the 8508A, select the required range.
2. On the Calibrator, set to zero output and Operate.
3. On the 8508A, press CAL to enter the CALIBRATION menu.
4. Press SAMPLE to initiate the calibration operation.

Calibration is complete when the Busy legend goes out and the calibrated measurement is displayed.

Range Gain Points

1. On the Calibrator, select the positive Range Gain point Output value.
2. On the 8508A, Press CAL to revert to CALIBRATION menu.
3. Select Set on the CALIBRATION menu.
4. Use the numeric keys with the SET VALUE menu to key in the true output value of the calibrator at the range gain value, then press Enter.
5. Press SAMPLE to initiate the calibration operation.
6. Calibration is complete when the Busy legend goes out and the calibrated measurement is displayed.
7. On the Calibrator, select the negative Range Gain point Output value.
8. Repeat steps 3 to 5 above to calibrate the negative Range gain point.
9. On the Calibrator, set STANDBY.
10. Press the DCI key to revert to the ranges menu.

AC Current Calibration

⚠⚠ Warning

The Calibrator can deliver a lethal electric shock.

To avoid electric shock when performing the following calibration procedures:

- **Never touch any lead or terminal unless you are absolutely certain that no dangerous voltage is present.**
- **Make sure that signal leads are in a safe condition before you handle them in any way.**

Initial Setup and Connections

1. Press the ACI key, and select the 200 μ A range.
2. Press the CONFIG key. In calibration mode in the ACI function resolution defaults to RESL6 and the 100Hz RMS filter is automatically selected. It is recommended that this resolution and 100Hz Filter is used for calibration of all ACI ranges.
3. Reselect ACI.
4. Confirm that the 8508A is configured for internal guard (External Guard is deselected) by checking that the Ext Grd legend does not appear on the left-hand display.
5. Ensure that the calibrator output is set to STANDBY and configured for Internal Guard (EXT GRD is deselected).
6. Connect the Calibrator to the 8508A as shown above.

Range Zero and LF Gain Calibration Procedure

Using the following procedure to calibrate range zero then range gain on all ACI ranges at the currents and frequencies detailed in Table 6-7. Just one range can be calibrated if required, but for a full-calibration start with the 200 μ A range and work up to the 20A range.

Table 6-7. AC Current Calibration Points and Sequence

8508A Range	Point	Current	Frequency
200 μ A	Zero (5 % Range)	10 μ A	300 Hz
	Range Gain	100 μ A	300 Hz
2 mA	Zero (0.5 % Range)	10 μ A	300 Hz
	Range Gain	1 mA	300 Hz
20 mA	Zero (0.5 % Range)	100 μ A	300 Hz
	Range Gain	10 mA	300 Hz
200 mA	Zero (5 % Range)	10 mA	300 Hz
	Range Gain	100 mA	300 Hz
2 A	Zero (5 % Range)	100 mA	300 Hz
	Range Gain	1 A	300 Hz
20 A	Zero (5 % Range)	1 A	300 Hz
	Range Gain	10 A	300 Hz

The procedure assumes the user has knowledge of the actual output value of the calibrator at each point, from a measurement or from a certificate of calibration. The **Set** feature allows a user to enter the true output value of the calibration standard where it differs from the nominal point. If the calibrator output is considered to be exactly nominal, use of the **Set** feature is not required, also **omit** steps 3-5.

On each range, the 8508A automatically recognizes the appropriate value as range zero or range gain from the applied signal amplitude.

1. On the 8508A, select the required Range.
2. On the Calibrator select Output Current and Frequency, Operate.
3. On the 8508A, Press CAL to revert to CALIBRATION menu.
4. Select Set on the CALIBRATION menu.
5. Use the numeric keys with the SET VALUE menu to key in the true output value of the calibrator, then press Enter.
6. Press SAMPLE to initiate the calibration operation.
Calibration is complete when the Busy legend goes out and the calibrated measurement is displayed.
7. On the Calibrator, set Output to STANDBY.
8. On the 8508A, press ACI key to revert to the ranges menu.

Frequency Calibration

The 8508A frequency calibration operation requires a signal at exactly 1MHz (Set is not available on the 8508A for frequency calibration). If the calibrator frequency output is not exactly nominal or sufficiently close to nominal it may be phase locked to an external reference frequency at the required output frequency applied to its rear panel phase lock input, for example from a laboratory frequency standard or off-air reference receiver. If used, the calibrator should be disconnected from the frequency reference and phase locking disabled before attempting any other calibration operations with the calibrator.

Alternatively, the 1MHz frequency reference may be used directly as an input signal for the 8508A for frequency calibration.

Initial Setup and Connections

1. Press the ACV key, select the 2 V range.
2. Confirm that the 8508A is configured for internal guard (External Guard is deselected) by checking that the Ext Grd legend does not appear on the left-hand display.
3. Ensure that the calibrator output is set to STANDBY and configured for Internal Guard (EXT GRD is deselected).
4. Connect the Calibrator to the 8508A as shown above.
5. If required, connect the calibrator rear panel phase lock input to a 1MHz reference frequency and enable phase locking via the front panel menus.

Procedure

1. On the calibrator select 1V 1MHz, Operate.
2. On the 8508A, Press CAL to enter the CALIBRATION menu, and select SPCL.
3. Select Freq to initiate the calibration operation.
Calibration is complete when the Busy legend goes out.
4. On the Calibrator, set STANDBY.

Exit From Calibration Mode and Non-Volatile Input Offset Adjustment

Use the following procedure to perform non-volatile input offset adjustment on all DCV and resistance ranges (including LoI, 2-wire, and 4-wire) for the front and rear inputs.

Initial Setup and Connections

1. Press the CAL key and select Quit.
2. From the CAL DUE ? menu select Quit.
3. The instrument will exit from CAL mode, the CAL legend on the main display will extinguish, and the right-hand display will revert to the currently selected function menu.
4. Disconnect all calibration leads and connect a 8508-7000K precision 4-wire short device to the front input terminals and also, if fitted, to the input terminals as shown above.

Procedure

Omit step 4 if the instrument is not fitted with rear input terminals.

1. Press the DCV key
2. Press the INPUT key and select Front.
3. From the INPUT menu select Zero Func to perform zero offset adjustment on all ranges.
4. From the INPUT menu select Rear. Repeat step 3.
5. Press the Ω key and select the 2Ω range.
6. Press the CONFIG key and select Filt, LoI and 4w Ω . Repeat steps 3 and 4.
7. Press the CONFIG key and select 2w Ω . Repeat steps 3 and 4.

8. Press the CONFIG key, select 4wΩ and de-select Lol. Repeat steps 3 and 4.
9. Press the CONFIG key and select 2wΩ. Repeat steps 3 and 4.
10. Press the ΩPLUS key and select TruΩ. From the TruΩ menu the 2Ω range.
11. Press the CONFIG key and select Filt and Lol. Repeat steps 3 and 4.
12. Press the CONFIG key and de-select Lol. Repeat steps 3 and 4.
13. Press the ΩPLUS key and select HiVΩ. From the HiVΩ menu the 20MΩ range.
14. Press the CONFIG key and select Filt and 2wΩ. Repeat steps 3 and 4.
15. Press the CONFIG key and select 4wΩ. Repeat steps 3 and 4.
16. Press the DCV key and remove the shorting devices from the input terminals.

Cal Due Date Entry and Calibration Mode Disable

On completion of all calibration operations it is recommended that the user updates the stored CAL due date with the date for next recalibration. For consistency, this date should be the same as the calibration due date shown on any calibration stickers the user may also attach to the instrument. It is also recommended that a calibration seal or integrity sticker is applied to prevent unauthorized access to the rear panel calibration enable switch.

Set Cal Due Date

1. Press the CAL key and select Quit.
2. From the CAL DUE ? menu select Enter.
3. Use the keypad to key in the calibration due date. Up to eight characters may be entered in any format. Any character available from the keypad may be used, but it is recommended that one of the common date formats such as dd.mm.yy or mm.dd.yy is used for ease of interpretation.
4. Press Enter to store the CAL due date.

Disable cal mode

1. Set the rear panel Calibration Enable switch to DISABLE .
2. Apply a security seal to cover the rear panel Calibration Enable switch to prevent unauthorized access.

ACV Spot Frequency Calibration

The ACV Spot frequency mode calibration is not normally performed as part of routine calibration. ACV Spot frequency calibration is only performed if the user intends to make use of spot frequency mode. In spot frequency mode the accuracy of AC Voltage measurements can be improved by calibrating the 8508A at specific frequencies of interest, reducing frequency response flatness errors at these points. The following procedure provides guidance on spot frequency calibration for users wishing to make use of Spot frequency mode.

To Calibrate at Spot Frequencies

Spot Calibration is available only when in AC Voltage function with Spot already selected on the ACV CONFIG menu. Each spot (six per range) can be calibrated at a valid input frequency to a non-nominal RMS value. In subsequent use, frequency response flatness errors are reduced within $\pm 10\%$ of the calibrated spot frequency.

Assuming that the 8508A is in calibration mode and the setup is connected as described above under *Initial Setup and Connections* for routine calibration. The configuration defaults to Tfer and RESL6 (both required).

Proceed as follows:

1. Select ACV and select the required Range.
2. Press the CONFIG key and select Spot.
3. Press the CAL key.
The CALIBRATION menu is displayed.
4. Select Set.
The SPOT CAL menu is displayed.
5. Select the soft key for the required spot, 1 to 6 (Sp1 to Sp6).
The SPOT ($x = 1$ to 6) RMS menu is displayed.
6. Key in the true RMS output value of the standard, then select Enter.
The SPOT FREQUENCY menu is displayed, showing the frequency at which the spot will be calibrated.
7. Press SAMPLE to initiate the calibration operation.
Calibration is complete when the Busy legend goes out and the calibrated measurement is displayed. The menu display reverts to the SPOT CAL menu.
8. On the Calibrator, set STANDBY.
9. On the 8508A, select other spots as required, repeating the process for each selection.
10. Exit from the SPOT CAL menu by pressing any hard key.

Performance Verification

The 8508A is a Digital Reference Multimeter offering state of the art performance. This procedure is intended as a guide for qualified metrology personnel who have access to a standards laboratory with equipment available to verify the performance of an instrument of this level of accuracy. The procedure assumes users are familiar with relevant best measurement practice, and will take precautions to avoid introducing errors from sources such as thermal emfs, leakages, electromagnetic interference, etc. It also assumes users will make adequate allowance for equipment stabilization and measurement settling times.

This routine performance verification procedure describes the test points and sequence of operations required to check the 8508A and assumes calibration references of adequate traceable uncertainty are available – in this case a Fluke 5720A calibrator and 5725A amplifier used with an 8508A-7000 Calibration Kit. The procedure assumes the user is able to calibrate and characterize the calibration standards, without describing the process required to do so. Refer to the Routine Calibration section for more information on the characterization process.

Equipment Requirements

The equipment required for performance verification of the 8508A is identical to the equipment required for routine calibration listed in Table 6-1. Alternate equipment may be used, but users should ensure it provides adequate uncertainties, and consider the impact of those uncertainties on allowable tolerance limits.

Interconnections

The Fluke 8508A-7000K Calibration kit contains a specially designed lead set which connects directly to the terminals of the 8508A, the 5720A, and the 5725A for the purpose of 8508A calibration and performance verification. It is recommended that this lead kit be used to avoid introducing measurement errors due to interconnections and to duplicate the configuration used by Fluke for 8508A calibration. A diagram showing the interconnections used in detail appears in the Routine Calibration section. If alternate leads are substituted users must ensure they are metrology grade leads, and of adequate voltage and current rating. Leads should be kept as short as possible, constructed from low capacitance low leakage dielectric material (PTFE) with low thermal emf terminations, and exactly duplicate the configuration and interconnections shown.

When checking the 2G Ω and 20G Ω resistance ranges the 1G Ω standard resistor supplied in the Fluke 8508A-7000K Calibration kit plugs directly into the 8508A front input terminals without any interconnecting leads. If alternate resistance standards are used for verifying performance of the resistance function, refer to the resistance measurements section of Chapter 3 'Making Measurements' for connection details.

Applicable Verification Tolerance and Conditions

The tolerances* listed in this verification procedure are derived from the 8508A 365 day Tcal $\pm 1^\circ\text{C}$ 99% Confidence Level Absolute specifications, which include contributions for the performance of the 8508A itself and the uncertainty of the calibration standards used to perform calibration adjustment of the 8508A at the Fluke factory. They are applicable to a verification performed within a period of 365 days from calibration and at a temperature within $\pm 1^\circ\text{C}$ of the temperature at which calibration was performed (23°C for calibrations performed by Fluke). It is recommended that these tolerances only be used for verification of the 8508A following calibration by Fluke, and if the above time period and temperature conditions are met. No allowance has been made for the uncertainty of the equipment used for verification. If the required conditions are met but the temperature lies within $\pm 5^\circ\text{C}$ of factory calibration, it is recommended that the user applies the 365 day Tcal $\pm 5^\circ\text{C}$ Absolute specifications instead.

For other circumstances, such as following calibration by another laboratory, it is recommended that the user derive verification tolerances* from the applicable 8508A 99% Confidence Level Relative to Standards specifications (90 day or 365 day) combined with the calibration uncertainties applicable to the previous calibration. (RSS summation is recommended, with calibration uncertainties also expressed at 99% confidence level).

The 8508A temperature coefficient specifications should also be applied if the temperature at verification is outside the range applicable to the 8508A specifications to be used.

Refer to Chapter 5 for further information on applying specifications and combining uncertainties.

Note that the tolerance testing is done with 7-digit resolution for speed and efficiency reasons. However, the tolerance limits are based on the tighter specifications of 8-digit measurement resolution. (The minor tolerance adders for the reduced resolution are disregarded as practically insignificant in most cases. These adders apply to DC volts,

DC current, ohms and Temperature function verifications.) We recommend that the 8-digit resolution mode be used if performance verification shows a borderline out-of-tolerance condition. In such cases 8-digit mode can be selected and the specifically borderline verification tests can be repeated. This will provide additional confidence in the in-tolerance or out-of-tolerance decision made during verification.

* Fluke guarantees 8508A performance verification using specifications stated to 99% confidence level.

Preparation

1. Allow the instrument to warm-up under power in the specified environment for at least 4 hours.
2. Press the CLEAR key, select Pwr Up Dflt to restore the power up default configuration and display the DCV menu.
3. Press the Test key and select Std to initiate a selftest. Should the instrument fail, contact your local authorized Service Center, ensuring that the full circumstances of the failure are reported.

DC Voltage Checks

⚠ ⚠ Warning

The Calibrator can deliver a lethal electric shock.

To avoid electric shock when performing the following calibration procedures:

- **Never touch any lead or terminal unless you are absolutely certain that no dangerous voltage is present.**
- **Make sure that signal leads are in a safe condition before you handle them in any way.**

Equipment Configuration

1. Ensure that the calibrator output is set to STANDBY and configured for Internal Guard (EXT GRD is deselected).
2. Connect the equipment as described for Routine Calibration.
3. Press the DCV key
4. Press the CONFIG key. Select Filt and RESL7.
5. Confirm that the 8508A is configured for internal guard (External Guard is deselected) by checking that the Ext Grd legend does not appear on the left-hand display.

Procedure

Repeat the following sequence for each range, starting with the 200mV range and working up to the 1kV range, as listed in Table 7-8. An input zero operation is performed on each 8508A range prior to performing the range verification measurements with the calibrator set to zero by range locking the calibrator in the range from which the output will be obtained.

1. Select the required 8508A range.
2. On the calibrator set the output to zero. Select OPERATE.

3. On the 8508A press the INPUT key, and select Zero Rng to initiate the zeroing operation.
The Busy legend will appear, and then extinguish when the zero operation has completed.
4. On the calibrator select the value required for verification in the positive polarity.
5. Note the 8508A reading. Compare the result with the allowable tolerance, taking into account any known error from nominal of the calibrator for this output.
6. On the calibrator select the value required for verification in the negative polarity.
7. Note the 8508A reading. Compare the result with the allowable tolerance, taking into account any known error from nominal of the calibrator for this output.
8. Set the calibrator output to STANDBY.

Table 6-8. DC Voltage Verification Points and Sequence

8508A Range	Voltage	Tolerance ¹
200 mV	0 mV	Perform input zero operation to calibrator range locked zero output
	+100 mV	± 0.00072 mV
	-100 mV	± 0.00072 mV
2 V	0 V	Perform input zero operation to calibrator range locked zero output
	+1 V	± 0.000045 V
	-1 V	± 0.000045 V
20 V	0 V	Perform input zero operation to calibrator range locked zero output
	+1 V	± 0.000009 V
	+10 V	± 0.000045 V
	+19 V	± 0.000081 V
	-1 V	± 0.000009 V
	-10 V	± 0.000045 V
	-19 V	± 0.000081 V
200 V	0 V	Perform input zero operation to calibrator range locked zero output
	+100 V	± 0.00065 V
	-100 V	± 0.00065 V
1000 V	0 V	Perform input zero operation to calibrator range locked zero output
	+1000 V	± 0.0066 V
	-1000 V	± 0.0066 V
1. Based on 365 day Tcal $\pm 1^{\circ}\text{C}$ 99%CL Absolute specifications. See comments in Applicable Verification Tolerance section above regarding the impact of calibration uncertainties and use of other specifications.		

AC Voltage Checks

⚠⚠ Warning

The Calibrator can deliver a lethal electric shock.

To avoid electric shock when performing the following calibration procedures:

- **Never touch any lead or terminal unless you are absolutely certain that no dangerous voltage is present.**
- **Make sure that signal leads are in a safe condition before you handle them in any way.**

Equipment Configuration

1. Ensure that the calibrator output is set to STANDBY and configured for Internal Guard (EXT GRD is deselected).
2. Connect the equipment as described for Routine Calibration.
3. Press the ACV key
4. Press the CONFIG key. Select Tfer On and RESL6.
5. Confirm that the 8508A is configured for internal guard (External Guard is deselected) by checking that the Ext Grd legend does not appear on the left-hand display.

Procedure

Repeat the following sequence for each range, starting with the 200mV range and working up to the 1kV range, as listed in Table 6-9.

1. Select the required 8508A range.
2. On the 8508A press CONFIG and select the appropriate filter for the point being verified as listed in Table 6-9.
3. On the calibrator set the output to the voltage and frequency for the point being verified as listed in Table 6-9. Set the output to OPERATE.
4. Note the 8508A reading. Compare the result with the allowable tolerance, taking into account any known error from nominal of the calibrator for this output.
5. Repeat steps 2 – 4 for each point to be verified on the 8508A range to be verified.
6. Repeat steps 1 – 5 for each 8508A range to be verified.
7. Set the calibrator output to STANDBY.

Table 6-9. AC Voltage Verification Points and Sequence

8508A Range	Voltage	Frequency	8508A Filter	Tolerance ¹
200 mV	100 mV	20 Hz	10 Hz	± 0.0195 mV
	100 mV	55 Hz	40 Hz	± 0.0175 mV
	100 mV	1 kHz	100 Hz	± 0.0149 mV
	100 mV	3 kHz	100 Hz	± 0.0175 mV
	100 mV	10 kHz	100 Hz	± 0.0175 mV
	100 mV	30 kHz	100 Hz	± 0.0445 mV
	100 mV	60 kHz	100 Hz	± 0.0995 mV
	100 mV	100 kHz	100 Hz	± 0.0995 mV
2 V	1 V	20 Hz	10 Hz	± 0.000144 V
	1 V	55 Hz	40 Hz	± 0.000119 V
	1 V	1 kHz	100 Hz	± 0.000099 V
	1 V	3 kHz	100 Hz	± 0.000119 V
	1 V	10 kHz	100 Hz	± 0.000119 V
	1 V	30 kHz	100 Hz	± 0.000295 V
	1 V	60 kHz	100 Hz	± 0.000795 V
	1 V	100 kHz	100 Hz	± 0.000795 V
	1 V	500 kHz	100 Hz	± 0.034000 V
	1 V	1 MHz	100 Hz	± 0.034000 V
20V	1 V	1 kHz	100 Hz	± 0.00032 V
	10 V	20 Hz	10 Hz	± 0.00144 V
	10 V	55 Hz	40 Hz	± 0.00119 V
	10 V	1 kHz	100 Hz	± 0.00099 V
	10 V	3 kHz	100 Hz	± 0.00119 V
	10 V	10kHz	100 Hz	± 0.00119 V
	10 V	30 kHz	100 Hz	± 0.00295 V
	10 V	60 kHz	100 Hz	± 0.00795 V
	10 V	100 kHz	100 Hz	± 0.00795 V
	10 V	500 kHz	100 Hz	± 0.34000 V
	10 V	1 MHz	100 Hz	± 0.34000 V
	19 V	1 kHz	100 Hz	± 0.00167 V

Table 6-9. AC Voltage Verification Points and Sequence (cont)

8508A Range	Voltage	Frequency	8508A Filter	Tolerance ¹
200V	100 V	20 Hz	10 Hz	± 0.0144 V
	100 V	55 Hz	40 Hz	± 0.0119 V
	100 V	1 kHz	100 Hz	± 0.0099 V
	100 V	3 kHz	100 Hz	± 0.0119 V
	100 V	10 kHz	100 Hz	± 0.0119 V
	100 V	30 kHz	100 Hz	± 0.0295 V
	100 V	60 kHz	100 Hz	± 0.0795 V
	100 V	100 kHz	100 Hz	± 0.0795 V
1000 V	500 V	55 Hz	40 Hz	± 0.088 V
	500 V	1 kHz	100 Hz	± 0.088 V
	500 V	3 kHz	100 Hz	± 0.088 V
	500 V	10 kHz	100 Hz	± 0.088 V
	500 V	30 kHz	100 Hz	± 0.223 V
	1000 V	1 kHz	100 Hz	± 0.331 V
	1000 V	30 kHz	100 Hz	± 1.476 V

1. Based on 365 day Tcal ±1°C 99%CL Absolute specifications. See comments in Applicable Verification Tolerance section above regarding the impact of calibration uncertainties and use of other specifications.

Resistance Checks

When verifying the resistance function, each of the resistance modes (Normal Ω , Tru Ω , LoI Ω and HiV Ω) must be individually checked. The following procedure assumes use of a multifunction calibrator and verifies each resistance mode in turn, range by range. If individual standard resistors are used it may be more convenient to check all the modes in turn for each resistance value to avoid connecting the same resistance standard several times during the calibration sequence. A 1 G Ω standard resistor is used for ranges above 200 M Ω as the highest resistance available from the 5720A calibrator is 100 M Ω .

Equipment Configuration

1. Ensure that the calibrator output is set to STANDBY and configured for Internal Guard (EXT GRD is deselected).
2. Connect the equipment as described for *Routine Calibration*.
3. Press the Ω key
4. Press the CONFIG key. Select Filt, RESL7, and 4W Ω .
5. Confirm that the 8508A is configured for internal guard (External Guard is deselected) by checking that the Ext Grd legend does not appear on the left-hand display.

Procedure

Perform the following sequence for each resistance mode and each range, as listed in Table 6-10, starting with the 2Ω range and working up to the 2GΩ range for the NormalΩ and NormalΩ LoI resistance modes. Then continue the sequence for the TruΩ and TruΩ LoI modes, starting with the 2Ω range and working up to the 20kΩ range. Finally complete the sequence for the HiVΩ mode, starting with the 20MΩ range and working up to the 20GΩ range. An input zero operation is performed on each 8508A range prior to performing the range verification measurements with the calibrator set to zero Ω. A separate zero operation is required on each range for each resistance mode.

Note that EX SNS (4-wire) is not available on the 5720A 100MΩ range, and the 8508-7000K 1GΩ standard resistor is used as a 2-wire device with the calibrator 2-wire resistance zero used for the corresponding zero point. 4WΩ is deselected on the 8508A when checking the 200 MΩ and 2GΩ range, range zero, and range gain points.

⚠ ⚠ Warning

The 8508 can deliver a lethal electric shock when operating in the High Voltage Resistance mode. Voltages up to 240V may appear on the terminals.

To avoid electric shock when performing the following calibration procedures:

- **Never touch any lead or terminal unless you are absolutely certain that no dangerous voltage is present.**
- **Make sure that signal leads are in a safe condition before you handle them in any way.**

1. Press the Ω key.
2. Press the CONFIG key and select Filt, RESL7, and 4wΩ. Ensure LoI is deselected.
3. Select the required 8508A range.
4. On the Calibrator, select zero Ω and Operate. Alternatively if using a standard resistor connect the standard resistor for a 4-wire resistance zero. (For the 200MΩ range and above, de-select Ex SNS on the calibrator and de-select 4WΩ on the 8508A.)
5. On the 8508A press the INPUT key, and select Zero Rng to initiate the zeroing operation.
The Busy legend will appear, and then extinguish when the zero operation has completed.
6. On the Calibrator, select Range Gain point Output value. Alternatively if using a standard resistor re-connect the standard resistor to measure its resistance.
7. Note the 8508A reading. Compare the result with the allowable tolerance, taking into account the actual value of the calibrator resistance output for this value or the calibrated value of the resistance standard used.
8. Repeat steps 3 – 7 for the remaining ranges of the selected resistance mode. (For the 2GΩ and 20GΩ ranges the 8508-7000K 1GΩ standard resistor is used in place of the calibrator. For the 200MΩ range and above, de-select Ex SNS on the calibrator and de-select 4WΩ on the 8508A).
9. Set the calibrator output to STANDBY.
10. Press the Ω key.

11. Press the CONFIG key and select Filt , RESL7, 4wΩ, and Lol.
12. Repeat steps 3 – 9 for the NormalΩ Lol ranges.
13. Press the Ω Plus key and select TruΩ.
14. Press the CONFIG key and select Filt , RESL7, and 4wΩ. Ensure Lol is deselected.
15. Repeat steps 3 – 9 for the TruΩ ranges.
16. Press the Ω Plus key and select TruΩ.
17. Press the CONFIG key and select Filt , RESL7, 4wΩ, and Lol.
18. Repeat steps 3 – 9 for the TruΩ Lol ranges.
19. Press the Ω Plus key and select HiVΩ.
20. Press the CONFIG key and select Filt , RESL7, and 4wΩ.
21. Repeat steps 3 – 9 for the HiVΩ ranges.

Table 6-10. Resistance Verification Points and Sequence

8508A Range	Resistance	Tolerance ¹	
		Normal Ω and TruΩ ²	Normal Ω Lol and TruΩ Lol ²
2 Ω	0 Ω	Perform input zero operation to calibrator range locked zero output	
	1 Ω	± 0.0000240 Ω	± 0.0000240 Ω
20 Ω	0 Ω	Perform input zero operation to calibrator range locked zero output	
	10 Ω	± 0.000133 Ω	± 0.000133 Ω
200 Ω	0 Ω	Perform input zero operation to calibrator range locked zero output	
	100 Ω	± 0.00101 Ω	± 0.00113 Ω
2 kΩ	0 kΩ	Perform input zero operation to calibrator range locked zero output	
	1 kΩ	± 0.0000101 kΩ	± 0.0000113 kΩ
20 kΩ	0 kΩ	Perform input zero operation to calibrator range locked zero output	
	10 kΩ	± 0.000101 kΩ	± 0.000113 kΩ
200 kΩ	0 kΩ	Perform input zero operation to calibrator range locked zero output	
	100 kΩ	± 0.00101 kΩ	± 0.00107 kΩ
2 MΩ	0 MΩ	Perform input zero operation to calibrator range locked zero output	
	1 MΩ	± 0.0000117 MΩ	± 0.0000142 MΩ
20 MΩ	0 MΩ	Perform input zero operation to calibrator range locked zero output	
	10 MΩ	± 0.000320 MΩ	± 0.000570 MΩ
200 MΩ	0 MΩ	Perform input zero operation to calibrator range locked zero output	
	100 MΩ	± 0.01950 MΩ	± 0.18700 MΩ
2 GΩ	0 GΩ	Perform input zero operation to calibrator range locked zero output	
	1 GΩ	± 0.0018750 GΩ	± 0.0018750 GΩ

Table 6-10. Resistance Verification Points and Sequence (cont)

8508A Range	Resistance	Tolerance ¹
		HiVΩ ²
20 MΩ	0 GΩ	Perform input zero operation to calibrator range locked zero output
	10 MΩ	± 0.000202 MΩ
200 MΩ	0 GΩ	Perform input zero operation to calibrator range locked zero output
	100 MΩ	± 0.00870 MΩ
2 GΩ	0 GΩ	Perform input zero operation to calibrator range locked zero output
	1 GΩ	± 0.0003150 GΩ
20 GΩ	0 GΩ	Perform input zero operation to calibrator range locked zero output
	1 GΩ	± 0.012675 GΩ
<p>1. Based on 365 day Tcal ±1°C 99%CL Absolute specifications. See comments in Applicable Verification Tolerance section above regarding the impact of calibration uncertainties and use of other specifications.</p> <p>2. Ranges require separate input zero operation in each resistance mode.</p>		

DC Current Checks

Equipment Configuration

1. Ensure that the calibrator output is set to STANDBY and configured for Internal Guard (EXT GRD is deselected).
2. Connect the equipment as described for Routine Calibration.
3. Press the DCI key
4. Press the CONFIG key. Select Filt and RESL7.
5. Confirm that the 8508A is configured for internal guard (External Guard is deselected) by checking that the Ext Grd legend does not appear on the left-hand display.

Procedure

Repeat the following sequence for each range, starting with the 200μA range and working up to the 20A range, as listed in Table 6-11. An input zero operation is performed on each 8508A range prior to performing the range verification measurements with the calibrator set to zero by range locking the calibrator in the range from which the output will be obtained.

1. Select the required 8508A range.
2. On the calibrator set the output to zero. Select OPERATE.
3. On the 8508A press the INPUT key, and select Zero Rng to initiate the zeroing operation.

The Busy legend will appear, and then extinguish when the zero operation has completed.

4. On the calibrator select the value required for verification in the positive polarity.
5. Note the 8508A reading. Compare the result with the allowable tolerance, taking into account any known error from nominal of the calibrator for this output.

6. On the calibrator select the value required for verification in the negative polarity.
7. Note the 8508A reading. Compare the result with the allowable tolerance, taking into account any known error from nominal of the calibrator for this output.

Table 6-11. DC Current Verification Points and Sequence

8508A Range	Current	Tolerance ¹
200 μ A	0 μ A	Perform input zero operation to calibrator range locked zero output
	+100 μ A	\pm 0.00190 μ A
	-100 μ A	\pm 0.00190 μ A
2 mA	0 mA	Perform input zero operation to calibrator range locked zero output
	+1mA	\pm 0.0000190 mA
	-1mA	\pm 0.0000190 mA
20 mA	0 mA	Perform input zero operation to calibrator range locked zero output
	+10mA	\pm 0.000200 mA
	-10mA	\pm 0.000200 mA
200 mA	0 mA	Perform input zero operation to calibrator range locked zero output
	+100mA	\pm 0.00530 mA
	-100mA	\pm 0.00530 mA
2 A	0 A	Perform input zero operation to calibrator range locked zero output
	+1A	\pm 0.0002260 A
	-1A	\pm 0.0002260 A
20 A	0 A	Perform input zero operation to calibrator range locked zero output
	+10A	\pm 0.004950 A
	-10A	\pm 0.004950 A

1. Based on 365 day Tcal \pm 1°C 99%CL Absolute specifications. See comments in Applicable Verification Tolerance section above regarding the impact of calibration uncertainties and use of other specifications.

AC Current Checks

Equipment Configuration

1. Ensure that the calibrator output is set to STANDBY and configured for Internal Guard (EXT GRD is deselected).
2. Connect the equipment as described for Routine Calibration.
3. Press the ACI key
4. Press the CONFIG key. Select RESL6 and 100Hz Filter.
5. Confirm that the 8508A is configured for internal guard (External Guard is deselected) by checking that the Ext Grd legend does not appear on the left-hand display.

Procedure

Repeat the following sequence for each range, starting with the 200µA range and working up to the 20A range, as listed in Table 6-12.

1. Select the required 8508A range.
2. On the calibrator set the output to the current and frequency for the point being verified as listed in Table 6-12. Set the output to OPERATE.
3. Note the 8508A reading. Compare the result with the allowable tolerance, taking into account any known error from nominal of the calibrator for this output.
4. Repeat steps 2 – 4 for each point to be verified on the 8508A range to be verified.
5. Repeat steps 1 – 5 for each 8508A range to be verified.
6. Set the calibrator output to STANDBY.

Table 6-12. AC Current Verification Points and Sequence

8508A Range	Current	Frequency	Tolerance ¹
200 µA	100 µA	300 Hz	± 0.0580 µA
	100 µA	1 kHz	± 0.0580 µA
	100 µA	3 kHz	± 0.0580 µA
	100 µA	5 kHz	± 0.0580 µA
	100 µA	10 kHz	± 0.0580 µA
2 mA	1 mA	300 Hz	± 0.000580 mA
	1 mA	1 kHz	± 0.000580 mA
	1 mA	3 kHz	± 0.000580 mA
	1 mA	5 kHz	± 0.000580 mA
	1 mA	10 kHz	± 0.000580 mA
20 mA	10 mA	300 Hz	± 0.00580 mA
	10 mA	1 kHz	± 0.00580 mA
	10 mA	3 kHz	± 0.00580 mA
	10 mA	5 kHz	± 0.00580 mA
	10 mA	10 kHz	± 0.00580 mA
200 mA	100 mA	300 Hz	± 0.0545 mA
	100 mA	1 kHz	± 0.0545 mA
	100 mA	3 kHz	± 0.0545 mA
	100 mA	5 kHz	± 0.0545 mA
	100 mA	10 kHz	± 0.0545 mA
2 A	1 A	300 Hz	± 0.000945 A
	1 A	1 kHz	± 0.000945 A
	1 A	3 kHz	± 0.001055 A
	1 A	5 kHz	± 0.001055 A
	1 A	10 kHz	± 0.001055 A
20 A	10 A	300 Hz	± 0.01140 A
	10 A	1 kHz	± 0.01140 A
	10 A	3 kHz	± 0.02740 A
	10 A	5 kHz	± 0.02740 A
	10 A	10 kHz	± 0.02740 A

1. Based on 365 day Tcal ±1°C 99%CL Absolute specifications. See comments in Applicable Verification Tolerance section above regarding the impact of calibration uncertainties and use of other specifications.

Frequency Checks

Equipment Configuration

1. Ensure that the calibrator output is set to STANDBY and configured for Internal Guard (EXT GRD is deselected).
2. Connect the equipment as described for Routine Calibration.
3. Press the ACV key, select the 2V range
4. Press the CONFIG key. Select Tfer On, Filt 40Hz.
5. Confirm that the 8508A is configured for internal guard (External Guard is deselected) by checking that the Ext Grd legend does not appear on the left-hand display.

Procedure

1. On the 8508A press MONITOR and then CONFIG. Deselect **FREQ GATE Fast**.
2. Press the MONITOR key and select **FREQ**.
3. On the calibrator set the output to the voltage to 1V and frequency to 1MHz. Set the output to OPERATE.
4. Note the 8508A frequency reading. Check the result is within $\pm 0.000012\text{MHz}$, taking into account any known error from nominal of the calibrator output frequency for this point.
5. Set the calibrator output to STANDBY.

Appendices

Appendix	Title	Page
A	Error Codes and Message.....	A-1
B	Rack Mount Kit.....	B-1
C	Rack Mount Slide Kit.....	C-1

Appendix A

Error Codes and Message

Introduction

Note

For the sake of completeness, this appendix collects together the error codes which might be generated either on the instrument front panel, or via the IEEE 488 system bus.

Error Detection

Errors are classified by the method with which they are handled:

- Recoverable errors are reported to the user and the Multimeter continues operation.
- Fatal errors are reported to the user but the Multimeter cannot recover and halts operation. Restarting the Multimeter from power on may clear the error, but generally such messages are caused by hardware or software faults, which require repair by a service center.

Error Messages

Fatal Errors

For all fatal errors, the error condition is reported only via the front panel.

The processor stops after displaying the message. A user must respond by retrying operation from power on, and initiate repair if the fault persists. The following is a list of error numbers displayed, with their associated fault descriptions:

9000-	System Kernel Fault
9001-	Run Time System Error
9002-	Unexpected Exception
9003-	PROM Sumcheck Failure
9004-	RAM Check Failure
9005-	Serial Interface Fault
9006-	Option Test Failure
9007-	Unknown Engine Instruction
9099-	Undefined Fatal Error

Recoverable Errors

Recoverable errors consist of:

- Command Errors
- Execution Errors
- Device-Dependent Errors

Command Errors can only be generated due to incorrect remote programming.

Some Execution Errors and all Device-Dependent Errors can all be generated by manual operation as well.

Each of the reportable Execution and Device-Dependent Errors are identified by a code number.

Command Errors (CME)

Command Errors are generated when the remote command does not conform to the device command syntax or to the IEEE 488.2 generic syntax. The CME bit (5) is set true in the Standard-defined Event Status Byte, but there is no associated queue.

The error is reported by the mechanisms described in the sub-section of Chapter 4 that deals with status reporting.

Errors generated due to incorrect front panel manipulation are not reported to the bus; and vice versa.

Execution Errors (EXE)

An Execution Error is generated if a received command cannot be executed because it is incompatible with the current device state, or because it attempts to command parameters which are out-of-limits.

In remote operation, the EXE bit (4) is set true in the Standard-defined Event Status Byte, and the error code number is appended to the Execution Error queue.

The error is reported by the mechanisms described in the sub-section of Chapter 4 that deals with status reporting, and the queue entries can be read destructively as LIFO by the Common query command EXQ?.

There is no queue when execution errors are generated during manual operation, the description of the error being presented directly on the Menu display.

The Execution Error numbers are given below, with their associated descriptions.

1000-	EXE queue empty when recalled	1021-	Test not allowed when Cal enabled
1001-	Option not installed	1024-	Illegal Range/Input Combination
1002-	Calibration disabled	1025-	Auto not available in Tru ratio
1005-	Input Zero not allowed in Scan	1026-	Probe identity unrecognized
1007-	Data entry error	1027-	Input Zero not allowed in PRT
1008-	Must be in AC Function	1028-	Only allowed in Voltage function
1010-	Divide-by-zero not allowed	1029-	Scan modes not allowed in PRT
1012-	No more errors in list	1030-	Scan modes not allowed in ACI/DCI
1013-	Data out of limit	1031-	4wV not available via rear input
1014-	Illegal Range/Function combination	1032-	Input Zero not allowed in Cal
1015-	Command allowed only in Remote	1033-	Calibration not allowed in PRT
1016-	Not in Special Calibration	1034-	PRT Coef Limit @ a+, b+, c+, a-, b-,
1035-	Cannot edit the default PRT	1036-	Block or Rolling average required

Device-Dependent Errors (DDE)

A Device-Dependent Error is generated if the device detects an internal operating fault (e.g., during self-test). The DDE bit (3) is set *true* in the Standard-defined Event Status Byte, and the error code number is appended to the Device-Dependent Error queue.

In remote mode operations, the error is reported by the mechanisms described in the sub-section of Chapter 4 that deals with status reporting, and the queue entries can be read destructively as LIFO by the Common query command DDQ?.

In local mode operations, the DDE status is checked at the end of the operation (e.g., Cal, Zero, Test). If *true*, an error has occurred, and the content of the last entry in the queue is displayed on the front panel.

If both bus and front panel users attempt to read the queue concurrently, the error data is read out destructively on a first-come, first-served basis. Thus one of the users cannot read the data on one interface as it has already been destroyed by reading on the other. This difficulty should be solved by suitable application programming to avoid the possibility of a double readout. Ideally the IEEE 488 interface should set the instrument into REMS or RWLS to prevent confusion. The bus can ignore the queue, but the front panel user will have to read it to continue.

Device-Dependent Error Lists

Device-dependent errors are associated mainly with test and calibration operations. The error numbers in the following pages are therefore listed in these categories. There is some overlap.

External Calibration Operations

Correction Errors

2000-	Error During Zero Cal
2001-	Error During Gain+ Cal
2002-	Error During Gain- Cal
2003-	Error During HF trim Cal
2004-	Error During Input Zero
2005-	Error During Lol Zero Cal
2006-	Error During Lol Gain Cal
2008-	Error During A to D Cal
2010-	Error During Frequency Cal
2012-	Error During DCcp Cal
2025-	Error During HiV Lin Read
2026-	Error During HiV Lin Calc

Corruptions

2014-	Serial Number Corrupt
2015-	Cal Due Date Corrupt
2017-	Bus Address Corrupt
2018-	Line Frequency Corrupt
2020-	Invalid Corrections (ram)
2021-	Calibration Corrupt
2022-	NV RAM Write Failure

Micellaneous

2109-	Bad Data from Analog Sys
2022-	NV Ram write failure
2023-	Engine – Load factor err
2024-	Engine – Store factor err

Self-Test Errors

These self-test error numbers will appear only if the test has not been successful, and should be reported for interpretation to your local Fluke service center, so that the fault can be analyzed.

A short description of the test step is also given.

Reference Tests	
2101	Main Ref Check.
2111	6.2V Ref Check.
DC Volts Tests	
2201	100mV Range Zero Check.
2211	1V Range Zero Check.
2221	10V Range Zero Check
2231	100V Range Zero Check.
2241	100mV Range Positive Gain Check.
2251	100mV Range Negative Gain Check.
2261	1V Range Positive Gain Check.
2271	1V Range Negative Gain Check.
2281	10V Range Positive Gain Check.
2291	10V Range Negative Gain Check.
2301	100V Range Positive Gain Check.
2311	100V Range Negative Gain Check.
DC Current Tests	
2401	100 μ A DC Range: Zero Input Check.
2411	100 μ A DC Range: 100 μ A Input Gain Check.
2421	1mA DC Range: Zero Input Check.
2431	1mA DC Range: 1mA Input Gain Check.
2441	10mA DC Range: Zero Input Check.
2451	100 μ A DC Range: 10mA Input Gain Check.
2461	100mA DC Range: Zero Input Check.
2471	100 μ A DC Range: 100mA Input Gain Check.
2481	1A DC Range: Zero Input Check.
2491	1A DC Range: 100mA Input Gain Check.
Current Tests (AC additional)	
2501	1mA AC Range: Zero Input Check.
2511	1mA AC Range: 1mA Input Gain Check.
Resistance Tests	
2601	Follower Offset Check.
2611	Follower 100mA Output Check.
2621	Follower 10mA Output Check.
2631	Follower 1mA Output Check.
2641	3.6V Clamp Check.
2651	6.7V Clamp Check.
2661	27V Clamp Check.
2671	Current Sink Clamp Check.
2681	10 μ A Current Sink and Follower 10V Output Check.
2691	1 μ A Current Sink Check.
2701	100nA Current Sink Check.
2711	10nA Current Sink Check.
2721	HV Ohms Follower Offset Check.
2731	HV Ohms Follower Output Voltage Check.
2741	240V Clamp Check.

AC Volts Tests	
2801	100mV AC Range: Zero Input Check.
2811	100mV AC Range: +179mV DC Input Checks at Pre-Amp Output
2821	100mV AC Range: -179mV DC Input Checks at Pre-Amp Output
2831	1V AC Range: Zero Input Check.
2841	1V AC Range: +993mV DC Input Checks at Pre-Amp Output
2851	1V AC Range: -993mV DC Input Checks at Pre-Amp Output
2861	1V AC Range: +993mV DC Input Checks at RMS Converter Output
2871	1V AC Range: -993mV DC Input Checks at RMS Converter Output
2881	10V AC Range: Zero Input Check.
2891	10V AC Range: +9.78V DC Input Checks at Pre-Amp Output
2901	10V AC Range: -9.78V DC Input Checks at Pre-Amp Output
2911	100V AC Range: Zero Input Check.
2921	100V AC Range: +9.78V DC Input Checks at Pre-Amp Output
2931	100V AC Range: -9.78V DC Input Checks at Pre-Amp Output
2941	1000V AC Range: Zero Input Check.
2951	1000V AC Range: +9.78V DC Input Checks at Pre-Amp Output
2961	1000V AC Range: -9.78V DC Input Checks at Pre-Amp Output

Appendix B

Rack Mount Kit

Introduction

A Rack Mount Kit for mounting the Multimeter in a standard 19-inch equipment rack is available as an Option.

For instructions on how to install the kit and mount the Multimeter in the equipment rack refer to Figure B-1 and the following procedure. The numbers in the drawing relate directly to the numbers in the procedure.

Note

Do not remove the top or bottom cover to rack mount the Multimeter.

1. Remove each of the two rear corner blocks by first removing their three hex screws.
2. With the corner blocks removed, re-install the top and bottom screws from each corner block. These screws secure the Multimeter's top and bottom covers.
3. Slide out and remove the side-cover-strips from the Multimeter.
4. Attach each front rack-mount ear as follows:
 - a. With the front rack-mount ear parallel to the front panel and extending away from the Multimeter, slide its extension into the Multimeter's side cover-strip opening.
 - b. Secure the rack-mount extension (side cover-strip opening) to the Multimeter using the three hex screws provided with the kit..
5. Remove the four feet and the two tilt-stands as follows:
 - a. Use a flat blade screwdriver to press the tab in the recess of the foot moulding, this allows the part to be removed.
 - b. Store safely for possible future use.

6. Fit the instrument to the rack as follows:
 - a. Attach the two rear rack-mount ears to the back of the equipment rack so they are ready to receive the instrument.
 - b. With assistance, slide the instrument into the rack, positioning the extension of the rear rack-mount ears in each side-cover strip opening. Push the instrument home, and secure the front rack-mount ears to the front of the equipment rack.

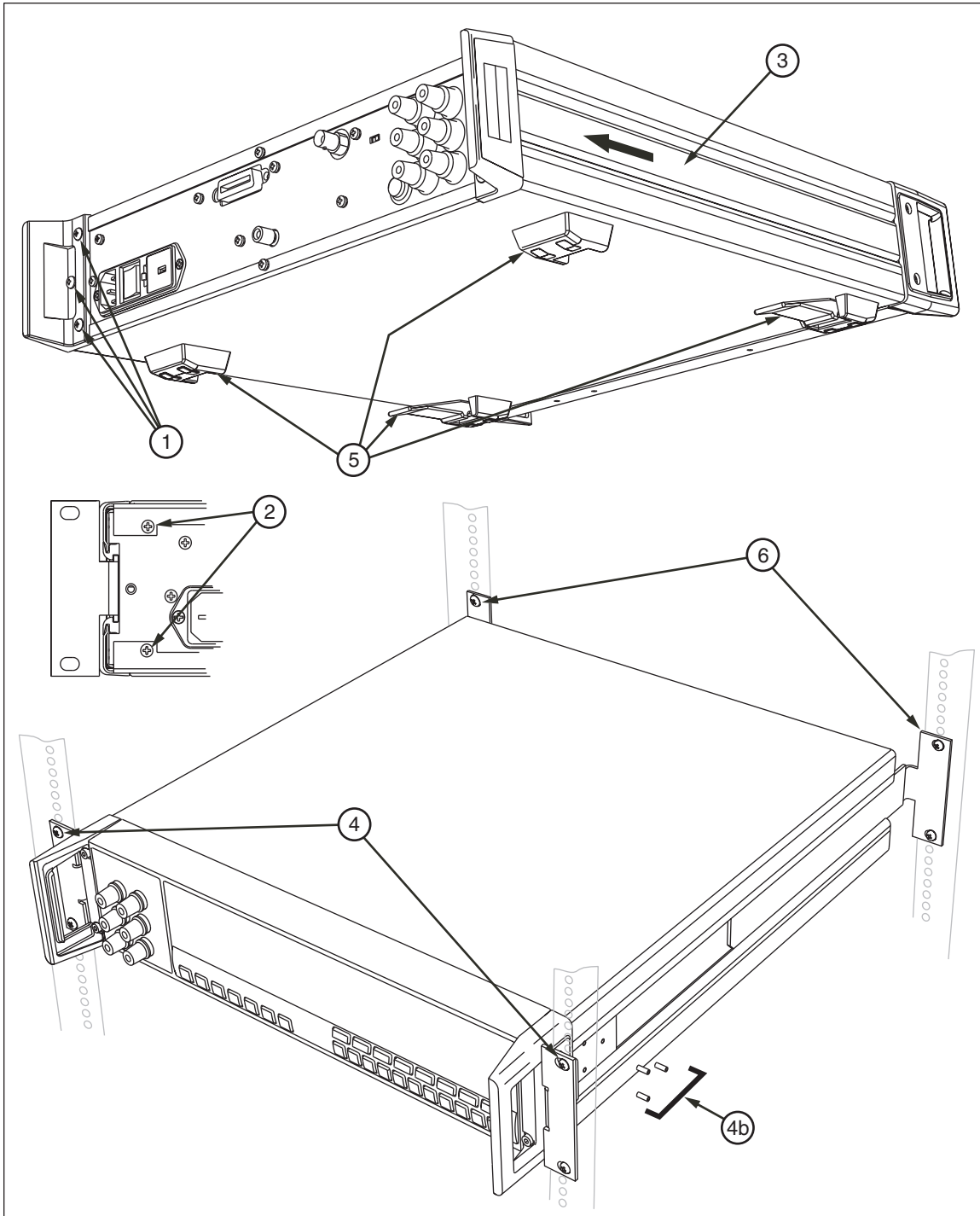

Figure B-1. Installing the 8508A Rack Mount Kit

adj359f.eps

Appendix C

Rack Mount Slide Kit

Introduction

A Rack Mount Slide Kit for mounting the Multimeter in a standard 19-inch equipment rack is available as an Option.

For instructions on how to install the kit and mount the Multimeter in the equipment rack refer to Figure C-1 and the following procedure. The numbers in the drawing relate directly to the numbers in the procedure.

Note

Do not remove the top or bottom cover to rack mount the Multimeter.

1. Remove each of the two rear corner blocks by first removing their three hex screws.
2. With the corner blocks removed, re-install the top and bottom screws from each corner block. These screws secure the Multimeter's top and bottom covers.
3. Slide out and remove the side-cover-strips from the Multimeter.
4. Attach each front rack-mount ear as follows:
 - a. With the front rack-mount ear parallel to the front panel and extending away from the Multimeter, slide its extension into the Multimeter's side cover-strip opening.
 - b. Secure the rack-mount extension (side cover-strip opening) to the Multimeter using the four hex screws provided with the kit.
 - c. Attach a slide bar to both sides of the Multimeter. Secure each using two screws.
5. Remove the four feet and the two tilt-stands as follows:
 - a. Use a flat blade screwdriver to press the tab in the recess of the foot moulding, this allows the part to be removed.
 - b. Store safely for possible future use.

6. Fit the instrument to the rack as follows:
 - a. Attach a pair of rack-mount ears and a slide-rail to each side of the equipment rack so they are ready to receive the instrument.
 - b. With assistance, and from the front of the equipment rack, insert the end of each slide bar (on the Multimeter) into the appropriate slide-bar on the equipment rack. Push the instrument home, and secure the front rack-mount ears to the front of the equipment rack.

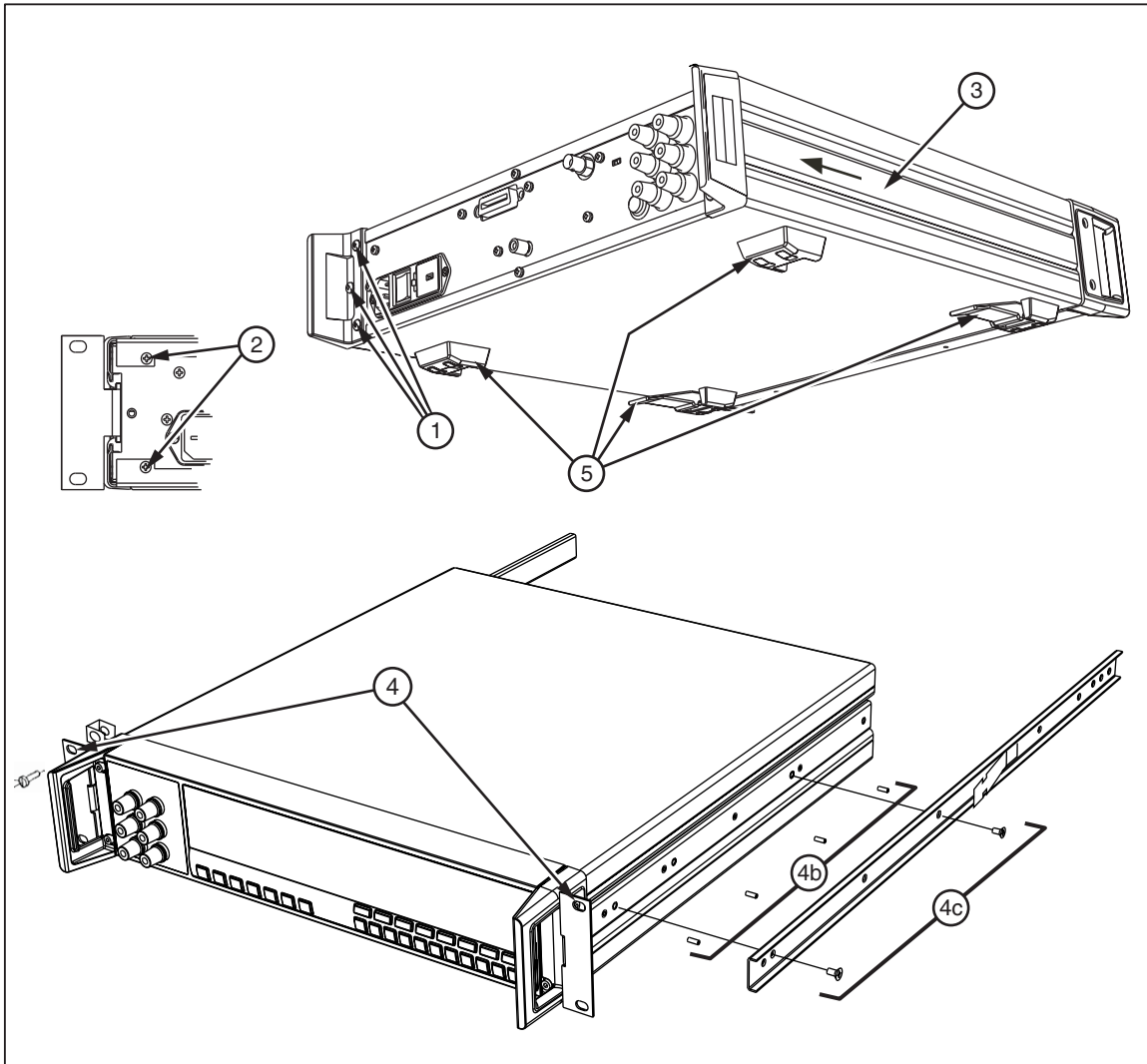

Figure C-1. Installing the 8508A Rack Mount Slide Kit

adj362f.eps