

Colaboração é a chave do sucesso na implementação do BIM

Pedro Soethe

Sr. Technical Sales Specialist | @psoethe





Hora de Mudar e Porque?

ERA DA DOCUMENTAÇÃO

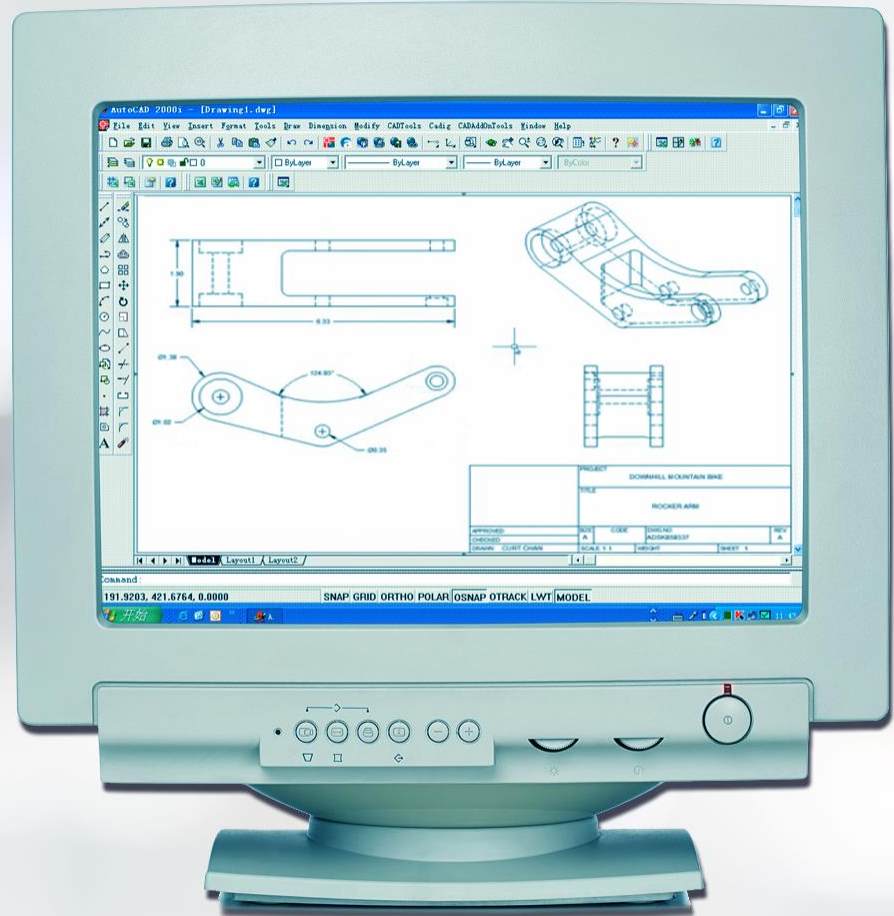

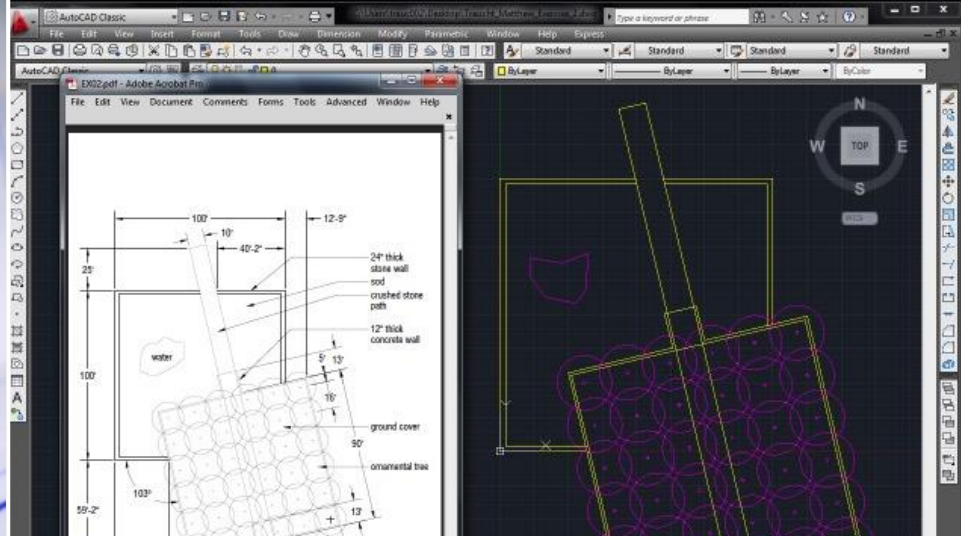

Silos de Informação



ERA DA OTIMIZAÇÃO



Tool icons: Home, Info, Terrain, Layers, Camera, Edit

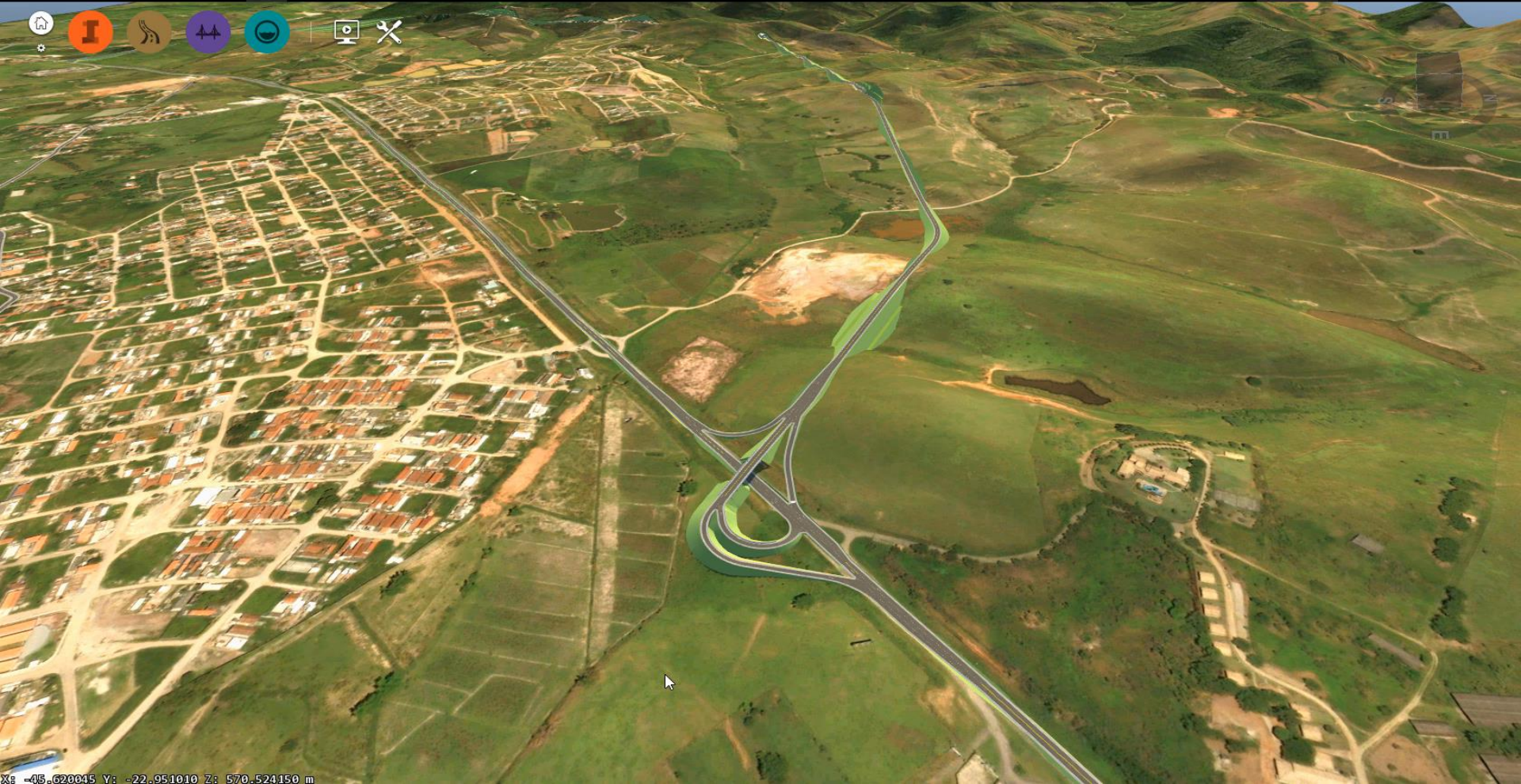

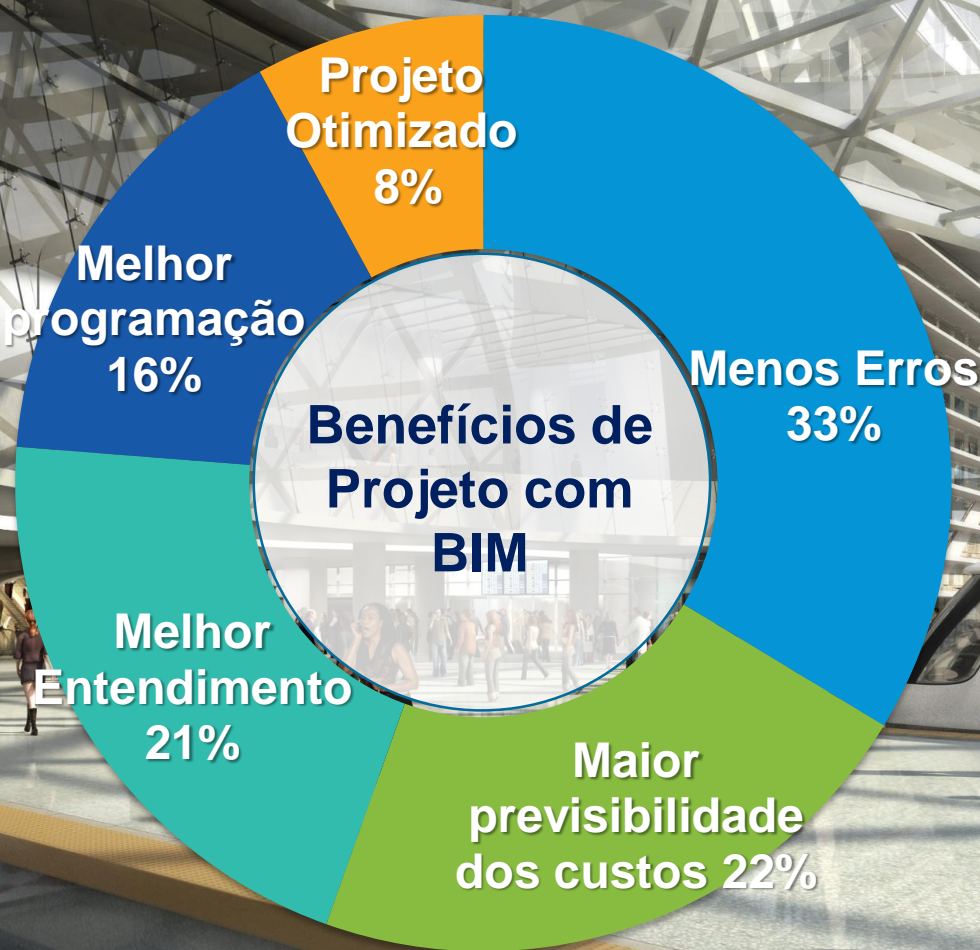

ERA DA CONEXÃO









Document Management

PASTAS PROBLEMAS

- Plantas
 - Novos teste
 - teste Arteris
- Arquivos do projeto
 - Equipe Alfa
 - Preliminar-Infraworks
 - Projeto Rotatória
 - Shared

Carregar

Pesquisar arquivos

<input type="checkbox"/>	Nome ▲	Descrição	Versão	Última atualização	Atualizado por	Marca de ...	Pr	⚙
<input type="checkbox"/>	 Contorno-Taubaté.iwm	Contorno-Taubaté	V4	abr 4, 2018 13:20	Pedro Luis Soethe C...			
<input type="checkbox"/>	 POC_Santos.iwm	POC_Santos	V1	abr 17, 2018 14:38	rafael.colucci@auto...			
<input type="checkbox"/>	 Taubaté-SP.iwm	Taubaté-SP	V1	abr 16, 2018 12:03	Pedro Luis Soethe C...			



Mudando a maneira de controlar documentação

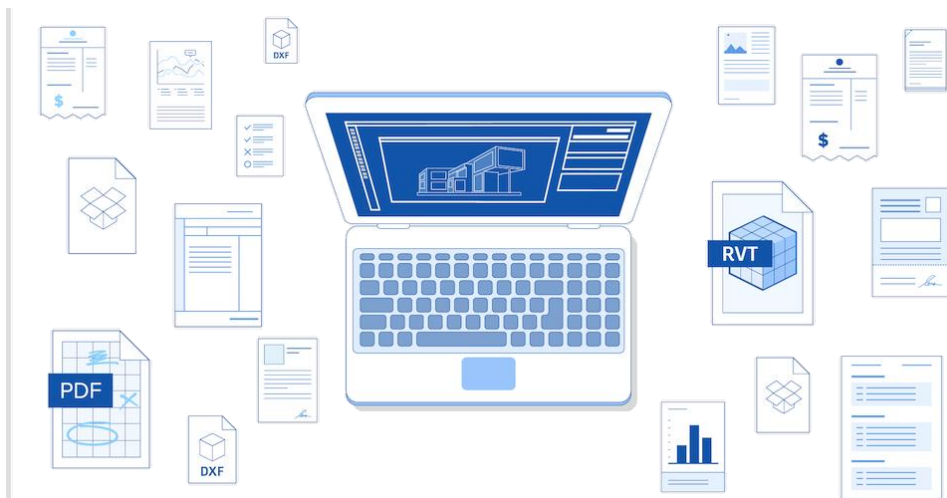
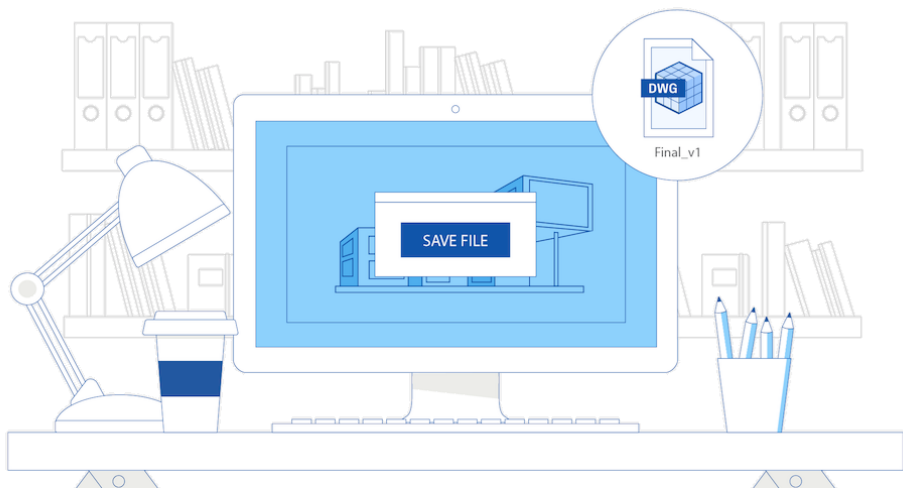

Alto volume de documentos e versões



Utilização de tecnologia movel.



Padrões e regras.

Tecnologias Típicas utilizadas



Soluções e
nuvem



PDF software

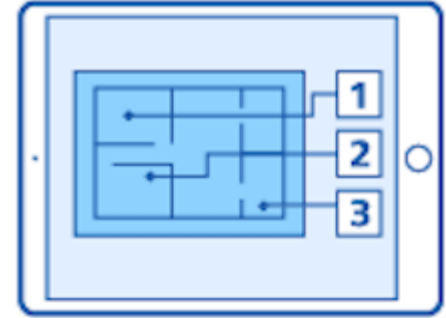

Aplicativo
s de
Campo

Tem um aplicativo para cada coisa



- Armazenamento na nuvem.
- Compartilhamento.
- Diretos de Acesso
- Acesso de dispositivos móveis.
- Controle de



- Criação e visualização de PDF
- Conversão de CAD para PDF
- Revisões
- Organização/Visualização/Comunicação

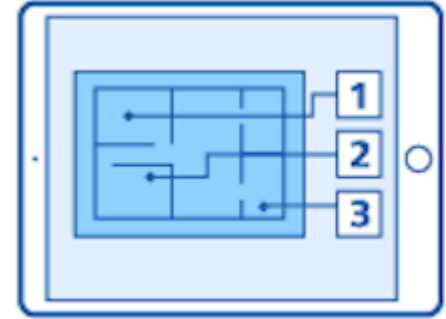

- Criação de Problemas
- Visualização
- Acesso offline
- Revisões
- Relatórios

Resultando em Silos de Informações.

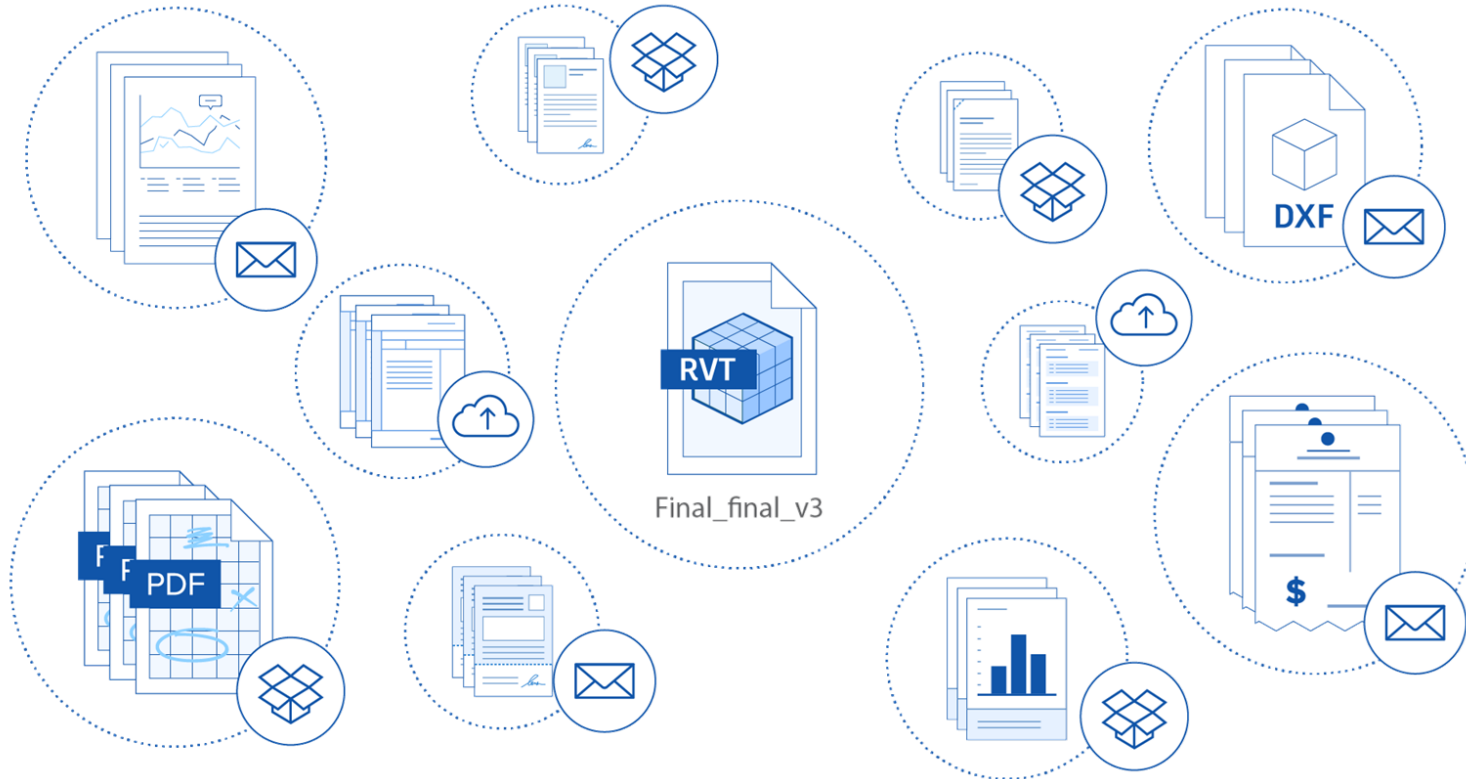

E problemas de controle de versão e arquivo.

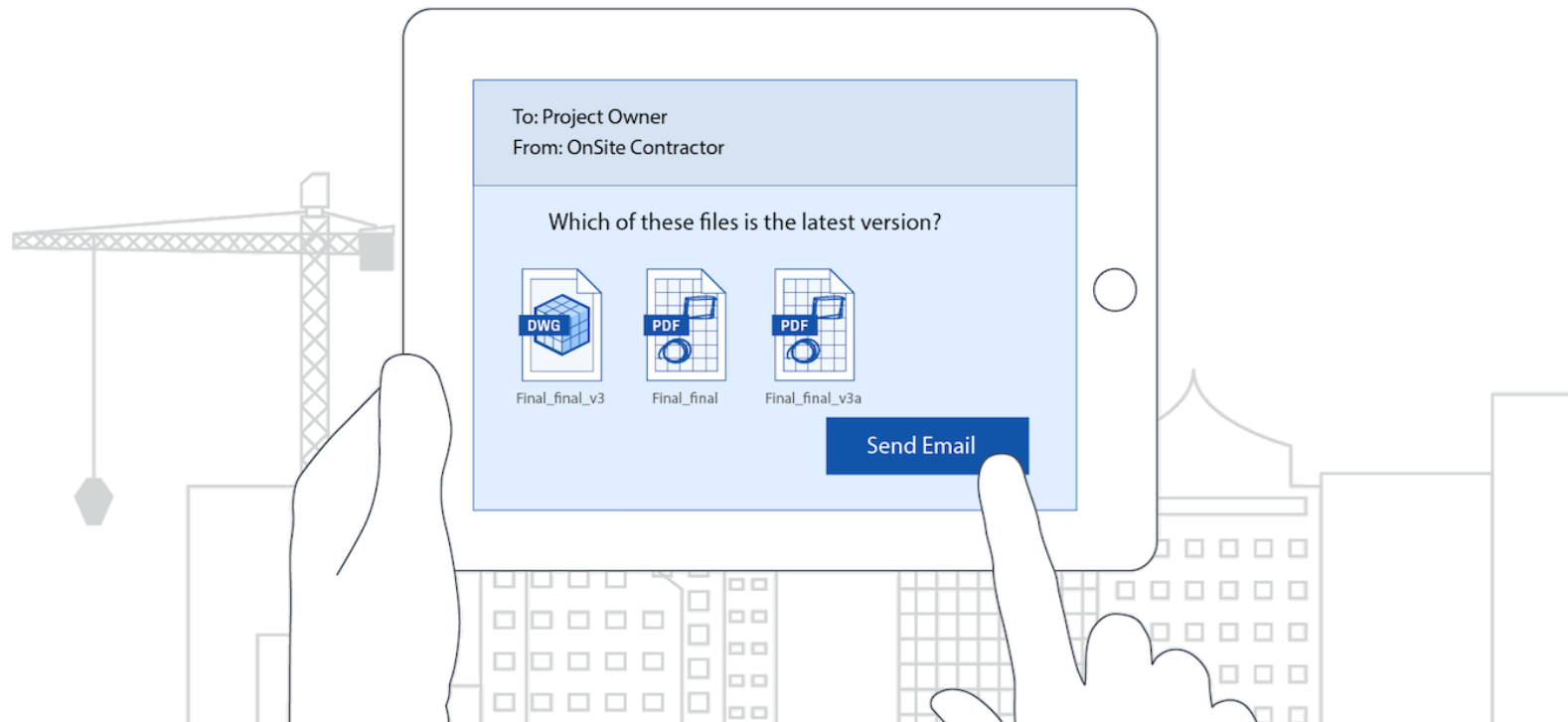



Ambiente de Trabalho Colaborativo

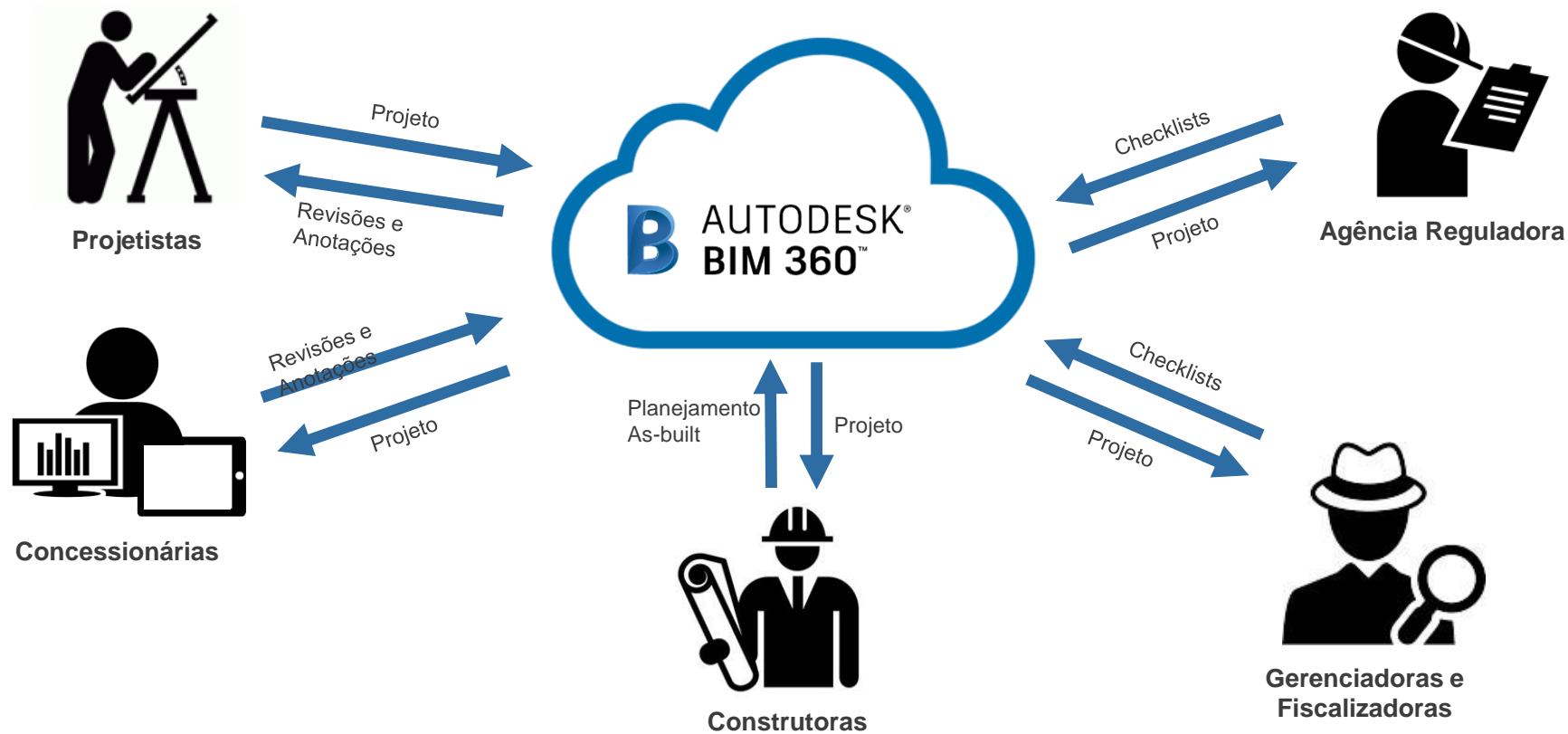



Publique



Compartilhe



Visualize

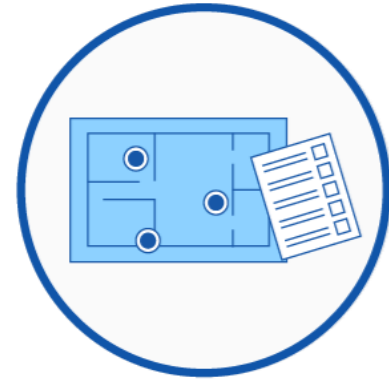

Revise



Publique

- Repositório Único
- Reconhecimento de Carimbo
- Visualização
- Separação Automática de folhas.

Doc #	Doc Name	Current	100% CD	50% CD	100% DD
<input type="checkbox"/> A - Model	Architectural Model	100% CD	V4	V3	
<input type="checkbox"/> A - 101	First Floor Plan	100% CD			V3
<input type="checkbox"/> A - 102	Second Floor Plan	50% DD	V2		V1
<input type="checkbox"/> A - 201	Exterior Elevations	50% CD		V4	
<input type="checkbox"/> A - 202	Exterior Elevations	100% CD	V5		
<input type="checkbox"/> A - 203	Exterior Elevations	100% CD	V3	V2	V
<input type="checkbox"/> A - 300	Sections	100% CD	V2		
<input type="checkbox"/> A - 300	Sections	100% CD	V4	V3	
<input type="checkbox"/> A - 300	Sections	100% CD	V3		



Compartilhe

- Registro de Documentos
- Controle de Acesso
- Versionamento

<input type="checkbox"/>	Publish	<input checked="" type="checkbox"/>	
<input checked="" type="checkbox"/>	Publish + View + Edit + Control	<input checked="" type="checkbox"/>	User
<input checked="" type="checkbox"/>	Publish + View	<input type="checkbox"/>	User
<input checked="" type="checkbox"/>	Publish + View + Edit	<input checked="" type="checkbox"/>	Role
<input checked="" type="checkbox"/>	Publish + View + Edit + Control	<input type="checkbox"/>	Role
<input checked="" type="checkbox"/>	Publish	<input checked="" type="checkbox"/>	Comp
<input checked="" type="checkbox"/>	Publish + View + Edit + Control	<input checked="" type="checkbox"/>	Cr
<input type="checkbox"/>	Publish + View	<input type="checkbox"/>	
<input type="checkbox"/>	Publish + View + Edit	<input type="checkbox"/>	

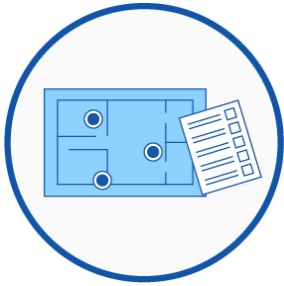

Revisão

- Markups
- Gerenciamento de comentários
- RFI
- Relatórios



Gerenciamento de Documentação e Controle

Plantas



Carregar

Arquivos do projeto

Preliminar-Infraworks

Projeto Rotatória

Geometrico

Geometrico

This PC > BIM 360 (Preview) > TS Construction > Rodovia BR123 > Project Files > Projeto Rotatória > Geometrico

Organize

- > 3D Objects
- > A360 Drive (pedro.soethe@autodesk.com)
- > BIM 360 (Preview)
 - > ADSK Technical Marketing
 - > Autodesk
 - > TS Construction
 - > Rodovia BR123
 - > Project Files
 - > Preliminar-Infraworks
 - > Projeto Rotatória
 - > Geometrico
 - > Pavimentação
 - > Sinalização

- > BIM 360 Team
- > Desktop
- > Documents
- > Downloads
- > Music
- > Pictures
- > Videos
- > Local Disk (C:)

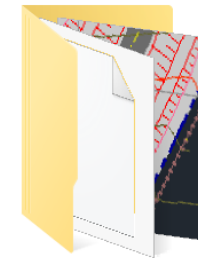

Civil

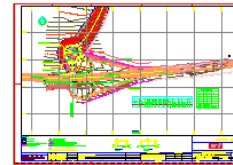

DE-SPD130147-130.600-006-F02-001-REV1.dwg

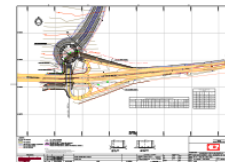

DE-SPD130147-130.600-006-F02-001-REV1.dwg

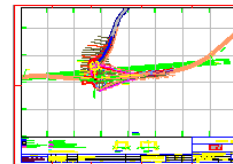

DE-SPD130147-130.600-006-F02-001-REV1.dwg

Colaboração



iO-PREFEITURA - 2D Views

visão

Adicionar

Mostrar arquivado

Pedro Luis Soethe...

04:25 pm | Privado

Arrumar alça de acesso, raio muito pequeno, aumentar

v1 (atual)

Mais nenhuma marca de revisão.



Arrumar alça de acesso, raio muito pequeno, aumentar



Em qualquer lugar A qualquer hora

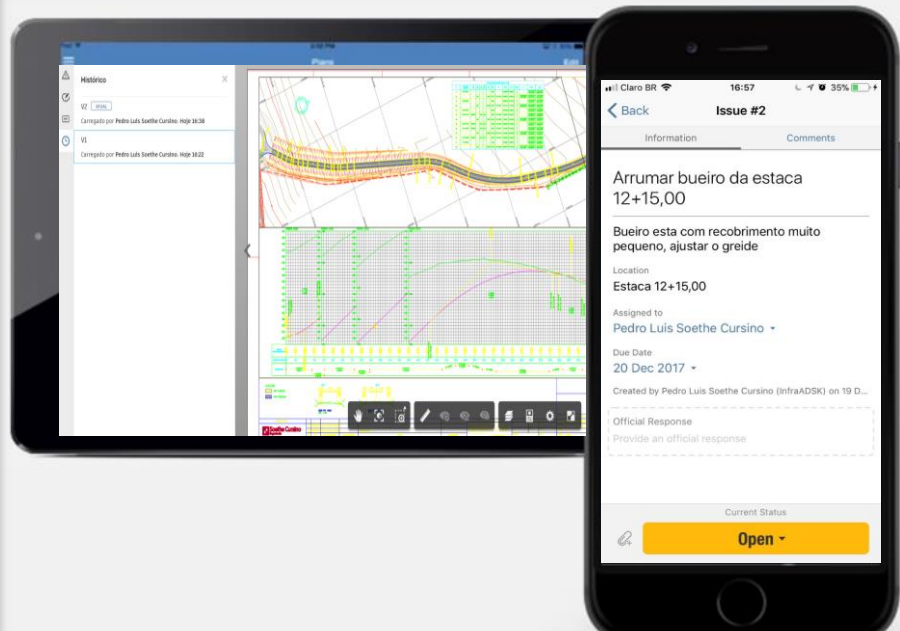

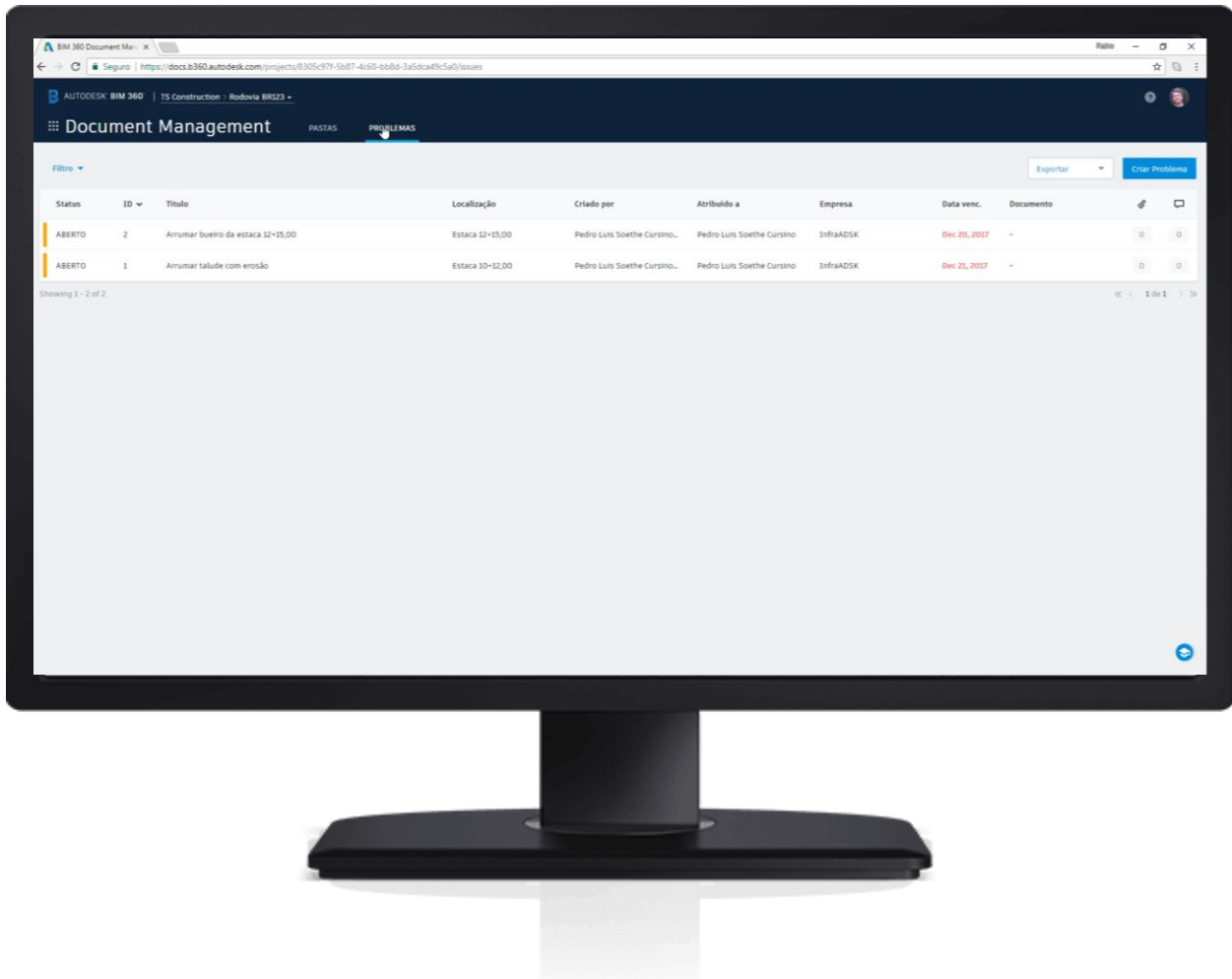



KEY
PERFORMANCE
INDICATOR

Folhas de verificação de serviços



PLASTER

- 1. Verify plaster mix, proportions and mixing equipment are as required and adequate.** + - N/A

Issue

Tap to enter comments
- 2. Verify spaces to be plastered have been heated before installation and provision is made for regulated ventilation.** + - N/A

Issue

Tap to enter comments
- 3. Verify masonry and concrete surfaces that are directly plastered have been roughened, cleaned and dampened and bonding requirements are met, including means to avoid telegraphing masonry joints.** + - N/A

Issue

Tap to enter comments
- 4. Verify setting and curing times are as required. Ensure minimum cement plaster is moist cured for a minimum of 48 hours.** + - N/A

Issue

Tap to enter comments
- 5. Verify adjacent spaces and surfaces are protected during plastering operations.** + - N/A

Issue

Tap to enter comments
- 6. Verify proper type of plaster required for various types of areas is provided.** + - N/A

Issue

Tap to enter comments
- 7. Verify adequate lighting is provided for proper workmanship.** + - N/A



Issue



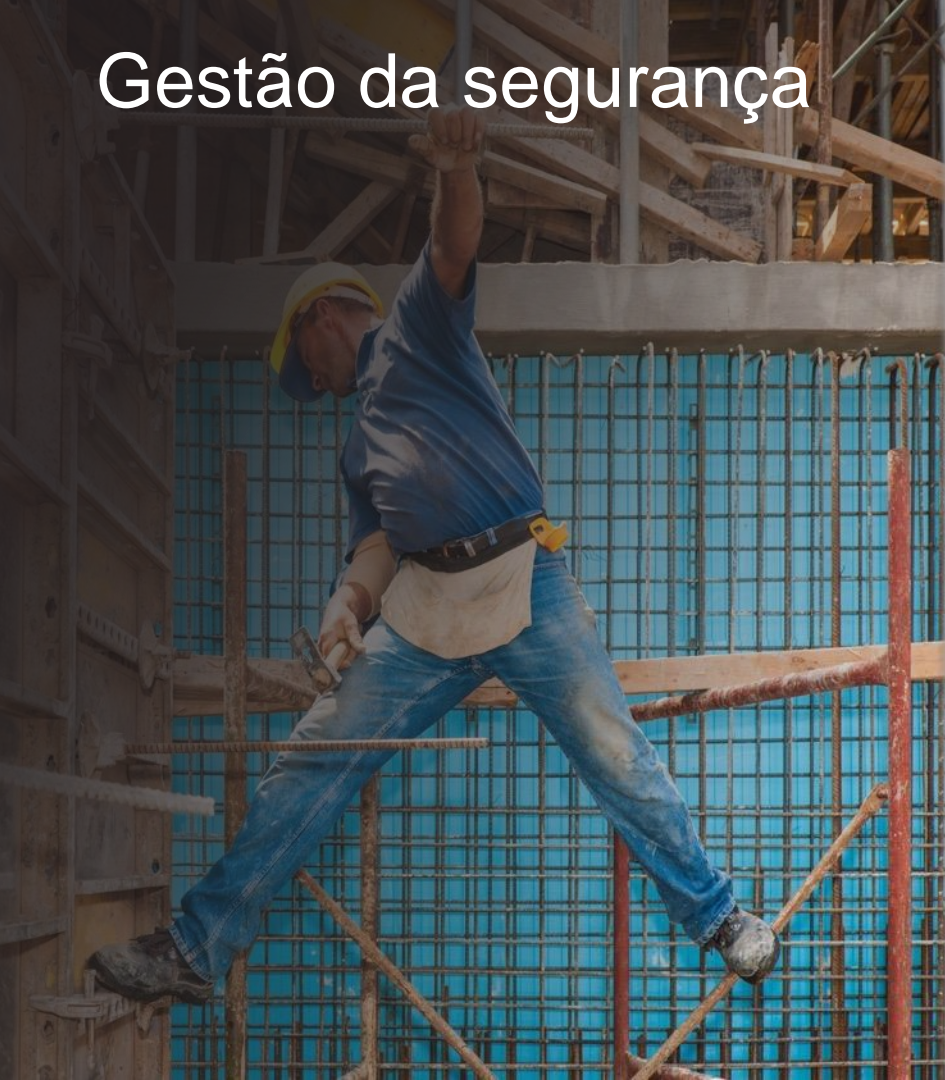





Tap to enter comments

Gestão da segurança



Pad 12:22 PM 30%

Checklists Find Checklists Overhead Crane Checklist   Header

1	Check BNL Periodic Inspection Tag <i>tag in place & visible</i>	<input checked="" type="radio"/> Yes	<input type="radio"/> No	N/A
 Issue				
2	Locate Crane Main Disconnect Switch <i>located to left of operator, clearly marked</i>	<input checked="" type="radio"/> Yes	<input type="radio"/> No	N/A
 Issue				
3	Check Pendant Controls or Controllers or Selector <i>functional</i>	<input checked="" type="radio"/> Yes	<input type="radio"/> No	N/A
 Issue				
4	Check Wire Rope or Chain for Damage <i>chain link cracked</i>	<input type="radio"/> Yes	<input checked="" type="radio"/> No	N/A
 1 Issue				
5	Check Hook	<input checked="" type="radio"/> Yes	<input type="radio"/> No	N/A
 Issue	<input type="text" value="Tap to enter comments"/>			
6	Check Upper Limit Switch	<input checked="" type="radio"/> Yes	<input type="radio"/> No	N/A
 Issue	<input type="text" value="Tap to enter comments"/>			
7	Check for Reverse Reeving	<input type="radio"/> Yes	<input type="radio"/> No	N/A
 Issue	<input type="text" value="Tap to enter comments"/>			
8	Check Brake System	<input type="radio"/> Yes	<input type="radio"/> No	N/A
 Issue	<input type="text" value="Tap to enter comments"/>			

Responsabilização e rastreabilidade

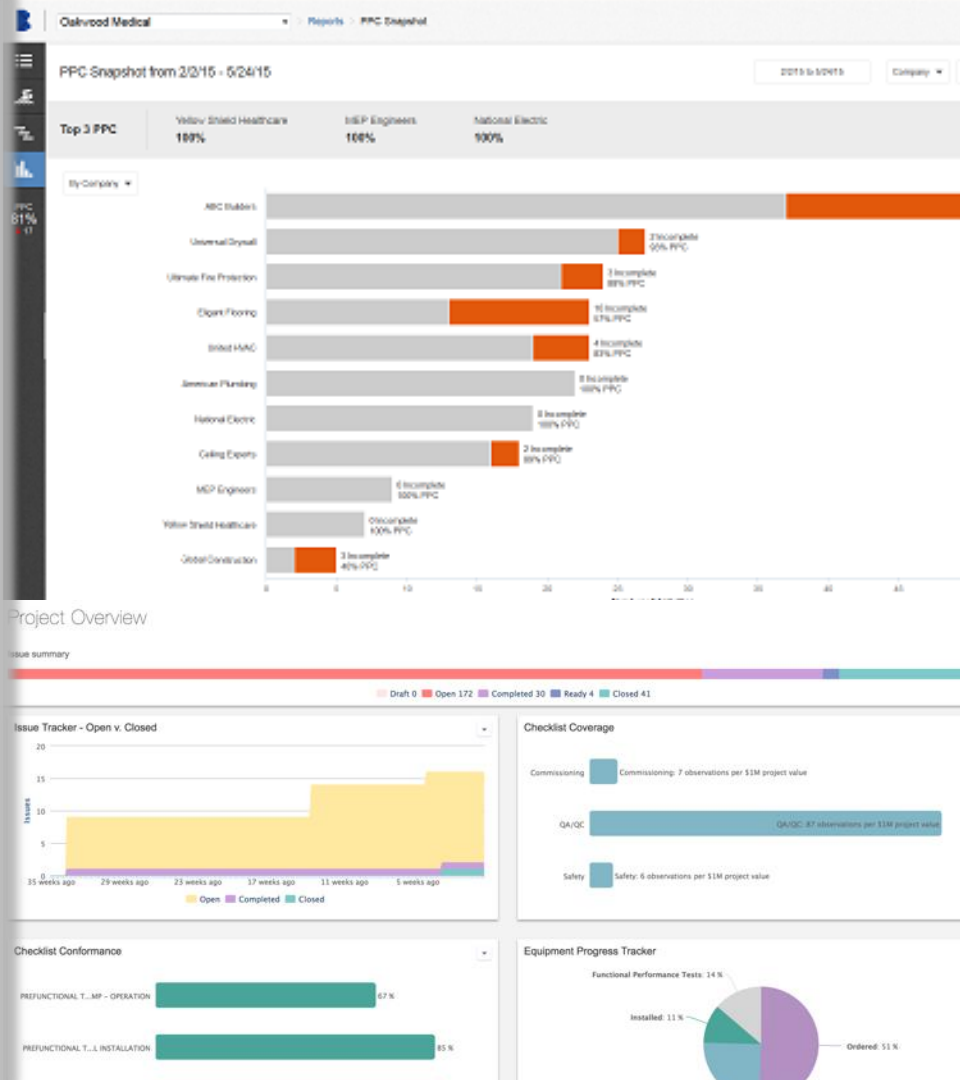



Folhas-tarefa e atribuição de atividades

AUTODESK BIM 360 FIELD Rodovia BR123 - Checklists

Overview | Close | Add | Edit | Delete | Print | More Actions | enter comment text

Filter: All Checklists | Type: all | Template: | ID: | Name: | Description: | Company: all | Location: all | Include sub-locations?: | Date Created: From: | To: | Status: all | Custom Properties: Check Period: all

ID	Name	Company	Status	Location Path	Checklist type	Template	Author	Date
000002	Controle de Alergo	InfraADSK	Open		QA/QC	Controle de Alergo	pedro.soethe@autodesk.com	19 D

To search template-specific custom properties or checklist comments, pick only one **Template**

Filters: New | Edit | Remove | 4 Item | Filter: All Checklists | Show: 50 | Refresh |

Issues Summary

Team Categories

Most Common Risk Causes

relatórios de acompanhamento da obra

Resultados comprovados

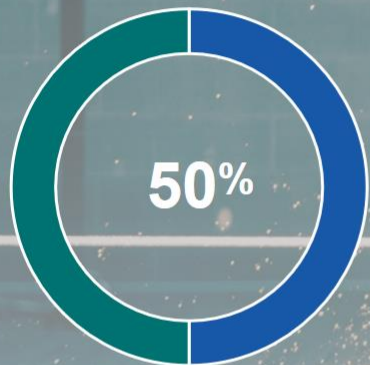

REDUÇÃO NO TEMPO
DE COORDENAÇÃO

Turner

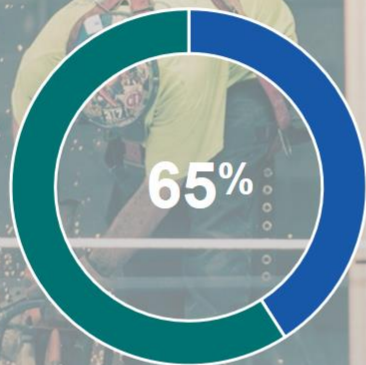

AVANÇO NO
CRONOGRAMA DE
PROJETO

I **IMCO**

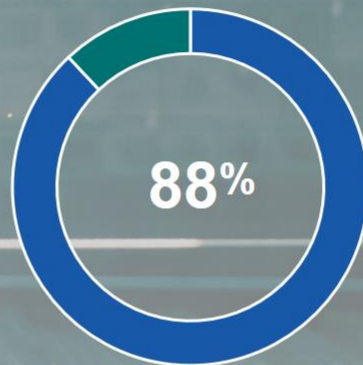

LOCAÇÃO MAIS
RÁPIDA

Barton
Malow

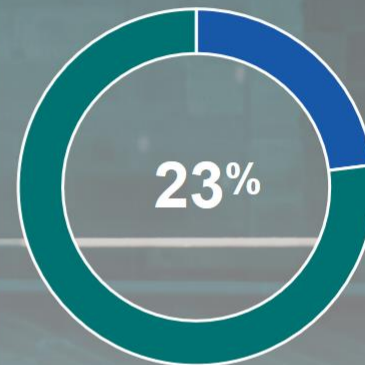

MAIS PRODUTIVIDADE
POR SEMANA DE
TRABALHO

SKANSKA

OBRIGADO!!!



AUTODESK®

Make anything™

pedro.soethe@autodesk.com

muntoaec.autodesk.com